

KATALOG 2023/2024

Aku sistem Power X-Change
Električni ručni alati
Stacionarni strojevi
Vrtni asortiman





POWER X-CHANGE

Power X-Change akumulatorski sistem	7	Akumulatorski čistač prozora	53
Power X-Change ALAT	10	Akumulatorski visokotlačni čistač	54
Akumulatorske bušilice	10	Akumulatorski stroj za metenje	56
Akumulatorske udarne bušilice	13	Akumulatorski čistač odvoda	56
Akumulatorski udarni odvijači	15	6u1 Akumulatorski hibridni kompresori	57
Akumulatorski odvijač za knauf	16	3u1 Akumulatorski kompresori	58
Akumulatorska udarna bušilica	16	Akumulatorski kompresori	58
Akumulatorske čekić bušilice	17	Akumulatorski auto kompresor	59
Akumulatorski mješalci za boju i ljepilo	20	Akumulatorska zračna pumpa	59
Akumulatorske kutne brusilice	21	Akumulatorski stroj za rezanje pločica	59
Akumulatorska glodalica u setu	25	Power X-Change pribor - Baterije // Punjači // Starter setovi	60
Akumulatorska glodalica	26	Vodič za baterije - vrijeme rada s baterijom PXC ALAT	65
Akumulatorska glodalica za kantiranje	26	Vrijeme punjenja baterija	69
Akumulatorska glodalica za utore	27	Power X-Change partneri	70
Akumulatorska blanja	27	Power X-Change VRT	71
Akumulatorske ubodne pile	28	Robotske kosilice	72
Akumulatorske ručne kružne pile	30	Benzinske kosilice (Power X-Change Elektro Start)	77
Akumulatorska mini ručna kružna pila	31	Akumulatorske kosilice	78
Akumulatorske višenamjenske pile	32	Akumulatorska ručna kosilica	85
Akumulatorske potezne preklopne pile	33	Akumulatorski univerzalni uređaj za sijanje	85
Akumulatorska preklopna pila	33	Akumulatorski prozračivači trave	86
Akumulatorska stolna kružna pila	34	Akumulatorska bušilica za zemlju	88
Akumulatorske tračne pile za metal	34	Akumulatorski čistač snijega	89
Akumulatorski višenamjenski alati	35	Akumulatorske kopačice	90
Akumulatorske brusilice za zidove	35	Akumulatorski trimeri za travu (rezna nit + nož)	90
Akumulatorska tračna brusilica	36	Akumulatorski trimeri za travu	91
Akumulatorske vibracione brusilice	36	Akumulatorski trimer za rubove travnjaka	94
Akumulatorska višenamjenska brusilica	37	Akumulatorski uređaji za čišćenje fuga	94
Akumulatorska ekscentrična brusilica	37	Akumulatorski uređaj za čišćenje terasa	95
Akumulatorski alat za brušenje i graviranje	37	Akumulatorske škare za živicu	97
Akumulatorska kutna polirka	38	Akumulatorski tresać maslina i plodova	99
Akumulatorska polirka	38	Akumulatorski višenamjenski vrtni alati	100
Akumulatorski pištolj za prskanje boje	39	Akumulatorske teleskopske lančane pile	101
Akumulatorski pištolj za silikon	39	Akumulatorske teleskopske škare za živicu	102
Aku pištolj za čavle / Aku pištolj za spajalice	40	Akumulatorske lančane pile	103
Akumulatorska klamerica	41	Akumulatorski oštrač lanaca	105
Akumulatorski radio	42	Akumulatorski puhači lišća	106
Akumulatorski zvučnik	42	Akumulatorski univerzalni puhač	108
Akumulatorske svjetiljke	43	Akumulatorski usisavači/puhači lišća	109
Akumulatorski reflektori	43	Akumulatorske škare za travu i grmlje	111
USB adapter za PXC bateriju	42	Akumulatorska pila za grane	112
Akumulatorski puhač	44	Akumulatorske škare za obrezivanje	112
Akumulatorski ventilator	44	Akumulatorske tlačne prskalice	113
Akumulatorski pištolj za vruće ljepljenje	44	Akumulatorski ventilator	114
Akumulatorski fen za vrući zrak	44	Pojas za PXC baterije	115
Sistemska kovčeg E-Case	45	Akumulatorski plinski grijač	115
Power X-Change pribor – Kovčezi // Torbe	48	Akumulatorska automatska vrtna pumpa	116
Akumulatorski usisavači suho/mokro	49	Akumulatorske vrtno pumpe	117
Akumulatorski štapni usisavač	51	Akumulatorske potopne pumpe za čistu vodu	118
Akumulatorski ručni usisavači	52	Akumulatorske potopne pumpe za nečistu vodu	120
Akumulatorski usisavač pepela	52	Vodič za baterije - vrijeme rada s baterijom PXC VRT	122



ELEKTRIČNI RUČNI ALATI

Uvrtnje	127	Kutne brusilice 115 mm	138
Akumulatorski odvijači 3,6 V	127	Glodanje + Struganje	139
Akumulatorske bušilice 12 V	127	Glodalice za utore u zidu	139
Akumulatorska udarna bušilica 12 V	129	Glodalica za utore	139
Odvijač za knauf	130	Glodalice	140
Bušenje + Miješanje	130	Blanje	140
Udarne bušilice	130	Piljenje	141
Čekić bušilice 2 kg	132	Ubodne pile	141
Čekić bušilice 5 kg	133	Ručne kružne pile	142
Čekići za razbijanje	135	Uranjajuća kružna pila	143
Mješalci za boju i ljepilo	136	Mini ručna kružna pila	143
Rezanje	137	Višenamjenske pile	144
Kutne brusilice 230 mm	137	Višenamjenski alati	145
Kutne brusilice 125 mm	137		

Brušenje	146
Akumulatorski alat za brušenje i graviranje	146
Alat za brušenje i graviranje	146
Vibracione brusilice	147
Tračna brusilica	147
Trokutaste brusilice	148
Višenamjenske brusilice	148
Ekscentrične brusilice	149
Brusilica za zidove // Brusilice za zidove i stropove	150
Električni sistemi za prskanje boje	151
Električni sistemi za prskanje boje	151
Električni pištolji za prskanje boje	151

Ostali električni ručni alati	152
Pištolj za vruće ljepljenje	152
Akumulatorski pištolj za vruće ljepljenje	152
Električna klamera	152
Akumulatorska klamera	152
Fenovi za vrući zrak	153
Laserska i detektorska tehnologija	154
360° Laserski nivelir	154
Laserski nivelir	155
Laserski daljinomjer	156
Laserska libela	157
Digitalni detektor	157



STACIONARNI STROJEVI

Obrada drva	160
Potezne preklapne pile	160
Preklapna pila	162
Kombinirana kružna pila	162
Stolne kružne pile s postoljem	163
Stolne kružne pile	165
Stolne blanje	166
Pila za izrezivanje	166
Tračne pile	167
Tokarski stroj za drvo	168
Industrijski usisavač	168
Sistemi za čišćenje	169
Usisavači suho / mokro	169
Usisavači pepela	174
Visokotlačni perači	175
Tehnologija komprimiranog zraka	176
Tihi kompresori	176
Kompresor (remenski pogon)	178
Kompresori (uljno podmazivanje)	178
Kompresori (bezuljni)	180
Mobilni kompresori (bezuljni)	180
Pneumatski alati i pribor za kompresore	181
Stacionarno brušenje	185
Stolne brusilice	185
Stolna brusilica mokro	186

Stolna brusilica suho/mokro	186
Stolne tračne brusilice	187
Obrada metala	187
Preklapna pila za metal	187
Stacionarno bušenje	188
Stupne bušilice	188
Obrada kamena i pločica	190
Strojevi za rezanje kamena	190
Strojevi za rezanje pločica	191
Dizanje	192
Električne dizalice	192
Lančana dizalica	193
Zakretna konzola	193
Potezna ručna vitla	194
Ručna vitla	194
Oprema za radionice	195
Viličar	195
Radni stol	195
Kolica za alat i pribor	195
Agregati	196
Inverterski benzinski agregati	196
Benzinski agregati	196
Pribor	198
Pribor – Električni ručni alat	198
Pribor – Stacionarni strojevi	207



VRTNI ASORTIMAN

Njega travnjaka i tla	222
Robotska kosilica	224
Električne kosilice	225
Benzinske kosilice	226
Ručne kosilice	230
Električni prozračivači trave	232
Benzinski prozračivač trave	233
Valjak za travu	234
Električni uređaj za čišćenje fuga	234
Kolica za sijanje trave	234
Električni trimeri za travu	235
Benzinski trimeri za travu	236
Benzinski višenamjenski vrtni alat	236
Benzinski trimeri za travu	237
Benzinske kopačice	239
Električne kopačice	240
Njega drveća i grmlja	241
Električne škare za živicu	242
Benzinske škare za živicu	244
Akumulatorske škare za travu i grmlje	245
Električna teleskopska lančana pila	246
Električne teleskopske škare za živicu	246
Električni višenamjenski vrtni alat	247
Električne lančane pile	248
Motorne pile	250
Električni oštrači lanaca	251

Pribor za obradu drva i benzinske alate	251
Električni usisavači/puhači lišća	252
Sjeckalice grana	253
Drobilice grana	253
Navodnjavanje	254
Potopna pumpa za čistu vodu s Aqua senzorom	258
Potopne pumpe za nečistu vodu s Aqua senzorom	259
Potopne pumpe za čistu i nečistu vodu	260
Potopne pumpe za čistu i nečistu vodu Eco	262
Potopne pumpe za nečistu vodu	262
Potopne pumpe za čistu vodu	264
Potopna pumpa za kišnicu	265
Potopne tlačne pumpe	266
Pumpe za zdence	267
Površinske pumpe Plus	268
Vrtne pumpe Plus	270
Vrtne pumpe	272
Automatska vrtna pumpa SMART	274
Automatske vrtne pumpe Plus	275
Automatska vrtna pumpa	275
Hidropaci Plus	276
Hidropaci	278
Motorne pumpe za vodu	279
Pribor za površinske pumpe	281
Pribor / Rezervni dijelovi	282
Podrška prodaji	292

EINHELL JE ZLATNI PARTNER

FC BAYERN MÜNCHENA!



MI SMO PARTNERI. EINHELL I FC BAYERN MÜNCHEN.

U potrazi za partnerom kojem su učinkovitost i izdržljivost jednako važni kao i nama koji cijenimo snagu i fleksibilnost i dosljedno slijedimo svoje ciljeve, pronašli smo ono što smo tražili: Od kolovoza 2021. **Einhell kao zlatni partner imenovan je stručnjakom za dom i vrt FC Bayerna.** Bilo na travnjaku ili u blizini Allianz Arene: Budite tu kada provodimo uzbuđujuće projekte s našim Power X-Change akumulatorskim sistemom kako bi igrači mogli učiniti sve što je moguće na nogometnom terenu.

PARTNERSTVO. NA ISTOJ RAZINI.

Inspirirajte ljude svakodnevno pružajući svoj maksimum. Učinkoviti timski rad i upornost u ispunjavanju svakog izazova. Uvjeriti vlastitom tehnologijom i kompetencijom. Einhell i FC Bayern ne dijele samo ljubav prema svom domu u srcu Bavarске, već i zajedničke vrijednosti i isti način razmišljanja. Kao tim iza momčadi FC Bayern, mi smo sada službeni stručnjak za dom i vrt, stručnjaci i pokretači za nesmetane utakmice i treninge.

**Pobjednik baterijskog testa susreće njemačkog prvaka rekordera.
Misija? Omogućiti sljedeću razinu!**

EINHELL OMOGUĆUJE. DVA NOVA ČLANA ZA FC BAYERN.

Andreas Kroiss, CEO Einhell Germany AG, jasno daje do znanja da partnerstvo s nogometnim klubom FC Bayern München uključuje rad na različitim razinama. „S dva Power X-Change proizvoda u posebnom FC Bayern München izdanju, učinili smo da srca mnogih „uradi sam“ majstora i hobi vrtlara među navijačima Bayern Münchena zakucaju malo brže.“

Akumulatorska kosilica od 36 V u FC Bayern dizajnu dostupna je u FC Bayern fan shopu. Pokreće ju motor bez četkica, ima središnje podešavanje visine košnje u 6 razina, sklopivu ručku podešivu u 3 razine i košaru za travu s indikatorom razine.

Snažna akumulatorska udarna bušilica TP-CD 18/50 Li-i Brushless u FC Bayern specijalnom izdanju također impresionira s više snage i duljim vremenom rada zahvaljujući svom motoru bez četkica. Kao i aku kosilica, aku udarna bušilica se isporučuje s dvije baterije. Sve baterije, punjači i Power X-Change alati međusobno su kompatibilni.

Više informacija o našim specijalnim FC Bayern proizvodima možete pronaći na www.einhell.de



Einhell
Official Home & Garden Expert





Einhell

AKU KOMPETENTNOST.

POWER X-CHANGE

DVA PARTNERA. JEDNA MISIJA.
MAKSIMALNE PERFORMANSE.



**EINHELL JE PONOSNI PARTNER
MERCEDES-AMG PETRONAS F1 TEAM-A.**

Official Tool Expert

E Einhell



**AMG
PETRONAS
FORMULA ONE TEAM**

**AKU KOMPETENTNOST.
KOJA KONTINUIRANO UVJERAVA.**



„Nevjerojatno smo ponosni što uvijek postižemo vrhunske ocjene u utrkama s najboljim natjecateljima i time jasno pokazujemo našu akumulatorsku kompetentnost.“

Andreas Kroiss, CEO Einhell Germany AG



AKU KOMPETENTNOST KOJA UVJERAVA. SAMO IZ EINHELLA.

Rano smo prepoznali želju naših kupaca za bežičnom slobodom i donijeli odluku da se u potpunosti usredotočimo na akumulatorsku tehnologiju i proširenje našeg Power X-Change akumulatorskog sistema. Brojne pobjede na testovima i vrhunske ocjene u testovima proizvoda poznatih stručnih časopisa i stručnjaka potvrđuju izvanrednu kvalitetu naših proizvoda i naglašavaju Einhellovu akumulatorsku kompetenciju. Naš cilj je nadahnuti našom Einhell akumulatorskom snagom i ponuditi našim korisnicima bežičnu slobodu, zabavu i uživanje tokom rada u kući i na vrtu. Power X-Change tako postaje sinonim za slobodu bez kabela.

EINHELL JAMSTVENO OBEĆANJE.

Razvijamo naše proizvode kako biste vi učinili sve mogućim. Veliku važnost pridajemo funkcionalnosti, sigurnosti i kvaliteti. To je naše obećanje i to je ono što predstavljaju naša različita jamstva.

- **Einhell jamstvo na alat**
Produljenje jamstvenog roka za vaš Einhell alat na 3 godine.
- **PurePOWER Brushless jamstvo**
Produljenje jamstvenog roka za sve PurePOWER Brushless proizvode na 10 godina.*
- **Power X-Change jamstvo na bateriju**
Produljenje jamstvenog roka za vašu Power X-Change bateriju na 3 godine.



* Ovo jamstvo pokriva samo kvarove motora bez četkica koji su uzrokovani greškom u materijalu ili proizvodnji!

PRODULJENJE JAMSTVA:

Informirajte se na Einhell web stranici, **otvorite** vlastiti MyEinhell korisnički račun i **registrirajte** jamstvo. Više informacija na:

einhell.hr
einhell.ba
einhell.rs
>>>



SLOBODA BEZ KABELA. ZA RADIONICU I VRT.

Nema više prekratkih ili prekinutih strujnih kabela.

Više ne morate brinuti o kratkim produžnim kablama ili dostupnim strujnim utičnicama. Sada alat/uređaj dolazi do projekta, a ne obrnuto. Jednostavno pričvrstite bateriju i odmah započnete s radom, bez obzira radi li se o kosilici, čekić bušilici ili usisavaču suho/mokro. To je osjećaj slobode bez kabela.

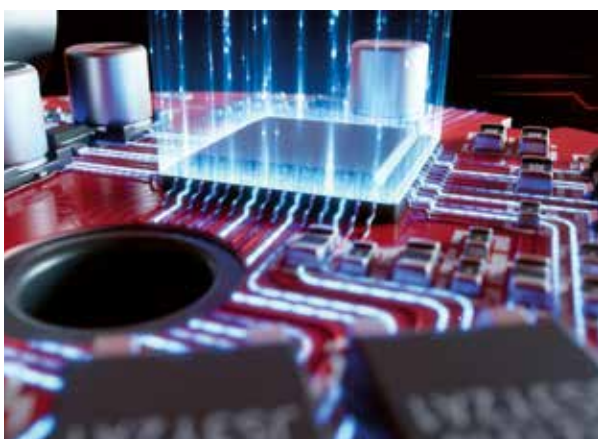

MODERNA TEHNOLOGIJA. DOKAZANA KVALITETA.

Za vrhunsku sigurnost i snagu.

Power X-Change baterije su srce naše platforme. Zato se koriste samo najbolje komponente kao što su snažne ćelije najnovije generacije i naša inteligentna baterijska elektronika upravljana procesorom. To osigurava učinkovitost, pouzdanost i trajnost i čini našu bateriju jednom od najboljih i najsigurnijih u industriji.



SNAŽNI ALATI. IZDRŽLJIVE BATERIJE.

Bez obzira koliko je vaš projekt zahtjevan, Power X-Change vas neće iznevjeriti.

Manje snage? Šalite se? Kao akumulatorski sistem za prave kreativne majstore, naši akumulatorski alati opremljeni su baterijama do 2700 W snage i kapacitetom od 8 Ah te stoga ni u čemu nisu slabiji u odnosu na klasične električne alate sa strujnim kablom! Bez obzira da li želite postaviti policu na zid ili bušiti kroz čvrsti betonski zid, uz Power X-Change dorasli ste svakom izazovu u pogledu snage i vremena rada.



1 BATERIJA. 1000 MOGUĆNOSTI. OD UBODNE PILE DO POTEZNE PREKLOPNE PILE.

Svestrani kao i vi: Snaga baterije za sve životne situacije.

Power X-Change je prvi akumulatorski sistem koji nudi veliki izbor alata za hobi vrtlare i uradi sam majstore. Više od 250 alata već je dio Power X-Change obitelji. Kako bismo vam ponudili slobodu bez kabela u još više područja života, otvorili smo našu platformu jakim partnerima. Zahvaljujući svestranoj Power X-Change bateriji, razni uređaji partnerskih tvrtki već se „napajaju Power X-Change-om“ - više informacija na stranici 70.



AKTIVAN SISTEM UPRAVLJANJA BATERIJOM. INTELEKTNI ELEKTRONIČKI KONTROLNI SISTEM.

Računalno potpomognut sustav za aktivno upravljanje baterijama trajno nadgleda i kontrolira sve sigurnosne procese električnih komponenti i pripadajućeg hardvera. To rezultira cijelim nizom prednosti:

- **MAKSIMIZIRANO VRIJEME RADA**
- **OPTIMIZIRANA SNAGA ALATA**
- **DULJI SERVISNI VIJEK BATERIJE**
- **VIŠE SIGURNOSTI**



TWIN-PACK® TEHNOLOGIJA. 18 V + 18 V = 36 V.

Ako uređaju treba više energije nego što to omogućuje jedna 18 V baterija, jednostavno dodamo drugu bateriju i generiramo 18 V + 18 V = 36 V. To nazivamo Twin-Pack © tehnologijom. Kada se udvostručuje napon (V), također se udvostručuje i snaga (W).

Double Twin-Pack tehnologija zauzvrat omogućuje još dulji rad bez ponovnog punjenja. U ovom slučaju koriste se četiri punjive baterije. Kada se potroši energija prve dvije baterije, sustav se automatski prebacuje na dvije dodatne baterije.



POWER X-CHANGE PLUS. PLUS U SNAZI.

Punjive baterije razlikuju se ne samo u pogledu vremena rada i težine. Ono što je također vrlo važno je snaga koju pružaju. Power X-Change PLUS tehnologija omogućuje više snage s istim brojem ćelija, tako da imate dovoljno snage čak i na vrlo zahtjevnim primjenama.

Ako, primjerice, želite koristiti kutnu brusilicu za rezanje, vrijeme rada (vidi oznaku Ah) općenito nije presudno. S druge strane vrlo je važna snaga. Automobil je korisna usporedba. Uzbrdo ili pri pretjecanju potrebno je više snage, drugim riječima više KS / kW.

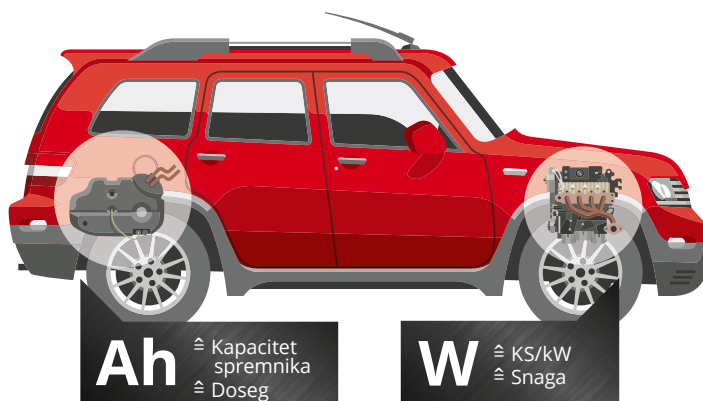

PUREPOWER BRUSHLESS – TEHNOLOGIJA MOTORA BEZ ČETKICA ZA NAJVEĆE ZAHTJEVE.

Različiti Power X-Change alati opremljeni su motorom bez četkica. Oni pružaju značajne prednosti u usporedbi s klasičnim motorima sa četkicama:

- **VIŠE SNAGE**
- **DULJE VRIJEME RADA**
- **DULJI ŽIVOTNI VIJEK**
- **KOMPAKTNIJI DIZAJN**
- **NEMA POTREBE ZA ODRŽAVANJEM**

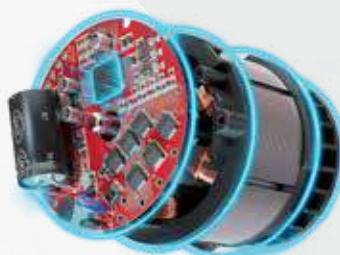

*Približne vrijednosti u usporedbi s konvencionalnim motorima sa četkicama. **Ako motore bez četkica uz dodatnu registraciju.



Einhell

AKU KOMPETENTNOST.

POWER X-CHANGE

1 BATERIJA.

ZA VIŠE OD 250 ALATA.



AKUMULATORSKA BUŠILICA 18 V



	TP-CD 18/60 Li Brushless - Solo PROFESSIONAL
PXC baterija napon / kapacitet	18 V / -
Vrijeme punjenja	-
Broj okretaja	0 - 500 / 0 - 2000 min ⁻¹
Maks. zakretni moment	60 Nm
Postavke zakretnih momenata	21+1
Stezna glava	13 mm
Težina proizvoda	1,3 kg (bez baterije)
Motor bez četkica	•
Metalna stezna glava	•
Metalni prijenos	•
Broj uklonjivih dodataka	-
LED svjetlo	•
Kopča za remen	•
Pribor	-
Broj baterija / punjača	0 / 0
Dodatna ručka	•
Pakiranje	Karton
Broj artikla	45.142.10



4 006825 659955

AKUMULATORSKE BUŠILICE 18 V



	TP-CD 18/50 Li Brushless - Solo PROFESSIONAL	TP-CD 18/50 Li Brushless (2x 2,0 Ah) PROFESSIONAL
PXC baterija napon / kapacitet	18 V / -	18 V / 2,0 Ah
Vrijeme punjenja	-	40 min
Broj okretaja	0 - 500 / 0 - 1800 min ⁻¹	0 - 500 / 0 - 1800 min ⁻¹
Maks. zakretni moment	50 Nm	50 Nm
Postavke zakretnih momenata	19+1	19+1
Stezna glava	13 mm	13 mm
Težina proizvoda	1,2 kg (bez baterije)	1,6 kg (s baterijom)
Motor bez četkica	•	•
Metalna stezna glava	-	-
Metalni prijenos	•	•
Broj uklonjivih dodataka	-	-
LED svjetlo	•	•
Kopča za remen	•	•
Pribor	-	-
Broj baterija / punjača	0 / 0	2 / 1x Power X-Charger 3 A
Dodatna ručka	-	-
Pakiranje	Karton	E-Box Basic kovčeg
Broj artikla	45.138.87	45.138.96



4 006825 644838



4 006825 649345

AKUMULATORSKE BUŠILICE 18 V

PURE POWER
BRUSHLESS



	TE-CD 18/40 Li Brushless - Solo EXPERT	TE-CD 18/40 Li Brushless (2x 2,0 Ah) EXPERT
PXC baterija napon / kapacitet	18 V / -	18 V / 2,0 Ah
Vrijeme punjenja	-	40 min
Broj okretaja	0 - 350 / 0 - 1450 min ⁻¹	0 - 350 / 0 - 1450 min ⁻¹
Maks. zakretni moment	40 Nm	40 Nm
Postavke zakretnih momenata	20+1	20+1
Stezna glava	10 mm	10 mm
Težina proizvoda	0,8 kg (bez baterije)	1,2 kg (s baterijom)
Motor bez četkica	•	•
Metalna stezna glava	-	-
Metalni prijenos	•	•
Broj uklonjivih dodataka	-	-
LED svjetlo	•	•
Kopča za remen	-	-
Pribor	-	-
Broj baterija / punjača	0 / 0	2 / 1x Power X-Charger 3 A
Dodatna ručka	-	-
Pakiranje	Karton	E-Box Basic kovčeg
Broj artikla	45.139.97	45.139.95



4 006825 658422



4 006825 655827

AKUMULATORSKA BUŠILICA 18 V

DRILL+
SCREW



	TE-CD 18/45 3X-Li +22 (1x 2,0 Ah) EXPERT
PXC baterija napon / kapacitet	18 V / 2,0 Ah
Vrijeme punjenja	40 min
Broj okretaja	0 - 450 / 0 - 1600 min ⁻¹
Maks. zakretni moment	45 Nm
Postavke zakretnih momenata	20+1
Stezna glava	13 mm
Težina proizvoda	1,5 kg (s baterijom)
Motor bez četkica	-
Metalna stezna glava	-
Metalni prijenos	•
Broj uklonjivih dodataka	3
LED svjetlo	•
Kopča za remen	•
Pribor	22-dijelni u praktičnoj kutiji
Broj baterija / punjača	1 / 1x Power X-Charger 3 A
Dodatna ručka	-
Pakiranje	E-Box Basic kovčeg
Broj artikla	45.139.90



4 006825 655810

AKUMULATORSKE BUŠILICE 18 V

**40 Nm
HIGH
POWER**



	TE-CD 18/40 Li - Solo EXPERT	TE-CD 18/40-1 Li (2x 1,5 Ah) EXPERT	TE-CD 18/2 Li Kit (2x 1,5 Ah) EXPERT
PXC baterija napon / kapacitet	18 V / -	18 V / 1,5 Ah	18 V / 1,5 Ah
Vrijeme punjenja	-	30 min	30 min
Broj okretaja	0 - 400 / 0 - 1500 min ⁻¹	0 - 400 / 0 - 1500 min ⁻¹	0 - 350 / 0 - 1250 min ⁻¹
Maks. zakretni moment	40 Nm	40 Nm	44 Nm
Postavke zakretnih momenata	21+1	21+1	20+1
Stezna glava	13 mm	13 mm	10 mm
Težina proizvoda	1,1 kg (bez baterije)	1,5 kg (s baterijom)	1,4 kg (s baterijom)
Motor bez četkica	-	-	-
Metalna stezna glava	-	-	-
Metalni prijenos	•	•	•
Broj uklonjivih dodataka	-	-	-
LED svjetlo	•	•	•
Kopča za remen	•	•	•
Pribor	-	-	-
Broj baterija / punjača	0 / 0	2 / 1x Power X-Charger 3 A	2 / 1x Power X-Charger 3 A
Dodatna ručka	-	-	-
Pakiranje	Karton	Kovčeg	Kovčeg
Broj artikla	45.139.25	45.139.39	45.138.30



AKUMULATORSKE BUŠILICE 18 V

**DRILL+
SCREW**



	TC-CD 18/35 Li - Solo CLASSIC	TC-CD 18/35 Li (1x 1,5 Ah) CLASSIC
PXC baterija napon / kapacitet	18 V / -	18 V / 1,5 Ah
Vrijeme punjenja	-	30 min
Broj okretaja	0 - 550 min ⁻¹	0 - 550 min ⁻¹
Maks. zakretni moment	35 Nm	35 Nm
Postavke zakretnih momenata	21+1	21+1
Stezna glava	10 mm	10 mm
Težina proizvoda	1,0 kg (bez baterije)	1,3 kg (s baterijom)
Motor bez četkica	-	-
Metalna stezna glava	-	-
Metalni prijenos	•	•
Broj uklonjivih dodataka	-	-
LED svjetlo	•	•
Kopča za remen	-	-
Pribor	-	-
Broj baterija / punjača	0 / 0	1 / 1x Power X-Charger 3 A
Dodatna ručka	-	-
Pakiranje	Karton	Karton
Broj artikla	45.139.27	45.139.14



AKUMULATORSKE UDARNE BUŠILICE 18 V

PURE POWER
BRUSHLESS



	TP-CD 18/60 Li-i Brushless - Solo PROFESSIONAL	TP-CD 18/60 Li-i Brushless +39 (2x 2,0 Ah) PROFESSIONAL
PXC baterija napon / kapacitet	18 V / -	18 V / 2,0 Ah
Vrijeme punjenja	-	40 min
Broj okretaja	0 - 500 / 0 - 2000 min ⁻¹	0 - 500 / 0 - 2000 min ⁻¹
Broj udaraca	0 - 8000 / 0 - 32000 min ⁻¹	0 - 8000 / 0 - 32000 min ⁻¹
Maks. zakretni moment	60 Nm	60 Nm
Postavke zakretnih momenata	21+1+1	21+1+1
Stezna glava	13 mm	13 mm
Težina proizvoda	1,3 kg (bez baterije)	1,7 kg (s baterijom)
Motor bez četkica	•	•
Metalna stezna glava	•	•
Metalni prijenos	•	•
Broj uklonjivih dodataka	-	-
LED svjetlo	•	•
Broj baterija / punjača	0 / 0	2 / 1x Power X-Charger 3 A
Dodatna ručka	•	•
Pribor	-	39-dijelni u praktičnoj kutiji
Pakiranje	Karton	E-Box Basic kovčeg
Broj artikla	45.142.05	45.142.06



4 006825 659092



4 006825 659962

AKUMULATORSKE UDARNE BUŠILICE 18 V

PURE POWER
BRUSHLESS



	TP-CD 18/50 Li-i Brushless - Solo PROFESSIONAL	TP-CD 18/50 Li-i Brushless (2x 2,0 Ah) PROFESSIONAL
PXC baterija napon / kapacitet	18 V / -	18 V / 2,0 Ah
Vrijeme punjenja	-	40 min
Broj okretaja	0 - 500 / 0 - 1800 min ⁻¹	0 - 500 / 0 - 1800 min ⁻¹
Broj udaraca	0 - 8000 / 0 - 28800 min ⁻¹	0 - 8000 / 0 - 28800 min ⁻¹
Maks. zakretni moment	50 Nm	50 Nm
Postavke zakretnih momenata	20+1+1	20+1+1
Stezna glava	13 mm	13 mm
Težina proizvoda	1,2 kg (bez baterije)	1,6 kg (s baterijom)
Motor bez četkica	•	•
Metalna stezna glava	•	•
Metalni prijenos	•	•
Broj uklonjivih dodataka	-	-
LED svjetlo	•	•
Broj baterija / punjača	0 / 0	2 / 1x Power X-Charger 3 A
Dodatna ručka	-	-
Pribor	-	-
Pakiranje	Karton	E-Box Basic kovčeg
Broj artikla	45.139.42	45.139.40



4 006825 644265



4 006825 642483

AKUMULATORSKE UDARNE BUŠILICE 18 V

48 Nm
HIGH POWER



	TE-CD 18/48 Li-i - Solo EXPERT	TE-CD 18/48 Li-i (2x 2,0 Ah) EXPERT
PXC baterija napon / kapacitet	18 V / -	18 V / 2,0 Ah
Vrijeme punjenja	-	40 min
Broj okretaja	0 - 400 / 0 - 1500 min ⁻¹	0 - 400 / 0 - 1500 min ⁻¹
Broj udaraca	0 - 6400 / 0 - 24000 min ⁻¹	0 - 6400 / 0 - 24000 min ⁻¹
Maks. zakretni moment	48 Nm	48 Nm
Postavke zakretnih momenata	21+1+1	21+1+1
Stezna glava	13 mm	13 mm
Težina proizvoda	1,3 kg (bez baterije)	1,7 kg (s baterijom)
Motor bez četkica	-	-
Metalna stezna glava	•	•
Metalni prijenos	•	•
Broj uklonjivih dodataka	-	-
LED svjetlo	•	•
Broj baterija / punjača	0 / 0	2 / 1x Power X-Charger 3 A
Dodatna ručka	•	•
Pribor	-	-
Pakiranje	Karton	E-Box Basic kovčeg
Broj artikla	45.139.26	45.139.35



4 006825 635775



4 006825 643930



AKUMULATORSKI UDARNI ODVIJAČI 18 V

PUREPOWER BRUSHLESS



180 Nm /
140 Nm
HIGH
POWER

	TP-CI 18 Li Brushless - Solo PROFESSIONAL	TE-CI 18/1 Li - Solo EXPERT
PXC baterija napon / kapacitet	18 V / -	18 V / -
Vrijeme punjenja	-	-
Broj okretaja	0 - 2900 min ⁻¹	0 - 2300 min ⁻¹
Maks. zakretni moment	180 Nm	140 Nm
Postavke zakretnih momenata	-	-
Držač bitova	Unutarnji šesterokutni 6,35 mm (1/4")	Unutarnji šesterokutni 6,35 mm (1/4")
Težina proizvoda	1,1 kg (bez baterije)	1,2 kg (bez baterije)
Motor bez četkica	•	-
LED svjetlo	•	•
Metalni prijenos	•	•
Elektronska kontrola brzine	•	•
Kopča za remen	•	•
Broj baterija / punjača	0 / 0	0 / 0
Pribor	-	-
Pakiranje	Karton	Karton
Broj artikla	45.100.30	45.100.34



AKUMULATORSKI UDARNI ODVIJAČI 18 V

PUREPOWER BRUSHLESS



	IMPAXXO 18/400 PROFESSIONAL	IMPAXXO 18/230 PROFESSIONAL NOVO
PXC baterija napon / kapacitet	18 V / -	18 V / -
Vrijeme punjenja	-	-
Broj okretaja	0 - 1000 min ⁻¹ / 0 - 1500 min ⁻¹ / 0 - 2100 min ⁻¹	0 - 2900 min ⁻¹
Maks. zakretni moment	400 Nm	230 Nm
Postavke zakretnih momenata	3	-
Držač bitova	Vanjski četverokutni (1/2")	Vanjski četverokutni (1/2")
Težina proizvoda	2,0 kg (bez baterije)	1,1 kg (bez baterije)
Motor bez četkica	•	•
LED svjetlo	•	•
Metalni prijenos	•	•
Elektronska kontrola brzine	•	•
Kopča za remen	•	•
Broj baterija / punjača	0 / 0	0 / 0
Pribor	Adapter za bitove, 3-dijelni set ključeva	Adapter za bitove
Pakiranje	Karton	Karton
Broj artikla	45.100.70	45.100.80



AKUMULATORSKI ODVIJAČ ZA KNAUF 18 V



	TE-DY 18 Li - Solo EXPERT
PXC baterija napon / kapacitet	18 V / -
Vrijeme punjenja	-
Broj okretaja	0 - 4000 min ⁻¹
Maks. zakretni moment (mekano)	6 Nm
Držač bitova	Unutarnji šesterokutni 6,35 mm (1/4")
Težina proizvoda	0,9 kg (bez baterije)
Podesiva dubina uvrtnja	•
Elektronska kontrola brzine	•
Prekidač za konstantni rad	•
Mekani rukohvat	•
LED svjetlo	•
Kopča za remen	•
Broj baterija / punjača	0 / 0
Pribor	1x bit tipa PH2 S2
Pakiranje	E-Box Basic kovčeg
Broj artikla	42.599.80



4 006825 635607

AKUMULATORSKA UDARNA BUŠILICA



	TC-ID 18 Li - Solo CLASSIC
PXC baterija napon / kapacitet	18 V / -
Vrijeme punjenja	-
Broj okretaja / broj udaraca	0 - 2600 min ⁻¹ / 0 - 41600 min ⁻¹
Kapacitet bušenja drvo	25 mm
Kapacitet bušenja, beton	13 mm
Kapacitet bušenja čelik	10 mm
Stezna glava	13 mm
Težina proizvoda	1,6 kg (bez baterije)
Elektronska kontrola brzine	•
Mekani rukohvat	•
Broj baterija / punjača	0 / 0
Dodatna ručka	•
Metalni graničnik dubine	•
Pakiranje	Karton
Broj artikla	45.139.60



4 006825 647754

AKUMULATORSKA ČEKIĆ BUŠILICE

Akumulatorska čekić bušilica
HEROCCO 36/28



ANTI-VIBRACIJSKA RUČKA
Za rad s niskim vibracijama

ELEKTRONSKA KONTROLA BRZINE
Odgovarajuća brzina za svaku primjenu

4 FUNKCIJE
Bušenje, udarno bušenje, klesanje sa ili bez fiksiranja

PNEUMATSKI UDARNI MEHANIZAM
Potreban nizak kontaktni pritisak za postizanje jakog udarca

POWER X-CHANGE LITIJ-IONSKA BATERIJA / TWIN-PACK TEHNOLOGIJA
Baterija se može koristiti za sve proizvode iz PXC obitelji – upotreba 2x 18 V Power X-Change baterije za još više snage

LED SVJETLO
Optimalno osvijetljeno radno područje čak i u nepovoljnim svjetlosnim uvjetima

AKUMULATORSKA ČEKIĆ BUŠILICA 36 V

TWIN-PACK®
18V → 36V
TECHNOLOGY



MOTOR BEZ ČETKICA
Više snage i dulje vrijeme rada

PUREPOWER
BRUSHLESS



HEROCCO

	HEROCCO 36/28 PROFESSIONAL
PXC baterija napon / kapacitet	2x 18 V / -
Vrijeme punjenja	-
Broj okretaja / broj udaraca / snaga udaraca	0 - 1100 min ⁻¹ / 0 - 5300 min ⁻¹ / 3,2 J
Kapacitet bušenja, beton	28 mm
Stezna glava	SDS-plus
Težina proizvoda	3,4 kg (bez baterije)
Motor bez četkica	•
Elektronska kontrola brzine	•
Anti-vibracijska glavna drška	•
Sigurnosno zaustavljanje kod preopterećenja	•
Pneumatski udarni mehanizam	•
Funkcije	4
LED svjetlo	•
Poluautomatska stezna glava	•
Mekani rukohvat	•
Broj baterija / punjača	0 / 0
Dodatna ručka	•
Metalni graničnik dubine	•
Pribor	-
Pakiranje	E-Box
Broj artikla	45.139.50



AKUMULATORSKE ČEKIĆ BUŠILICE 18 V

PUREPOWER
BRUSHLESS



Ilustrativna slika



	TP-HD 18/26 Li Brushless – Solo PROFESSIONAL NOVO	HEROCCO 18/20 PROFESSIONAL
PXC baterija napon / kapacitet	18 V / –	18 V / –
Vrijeme punjenja	–	–
Broj okretaja / broj udaraca / snaga udaraca	0 - 1200 min ⁻¹ / 0 - 5500 min ⁻¹ / 2,6 J	0 - 1200 min ⁻¹ / 0 - 5500 min ⁻¹ / 2,2 J
Kapacitet bušenja, beton	26 mm	20 mm
Stezna glava	SDS-plus	SDS-plus
Težina proizvoda	3,1 kg (bez baterije)	2,1 kg (bez baterije)
Motor bez četkica	•	•
Elektronska kontrola brzine	•	•
Anti-vibracijska glavna drška	•	•
Sigurnosno zaustavljanje kod preopterećenja	•	•
Pneumatski udarni mehanizam	•	•
Funkcije	4	4+1
LED svjetlo	•	•
Poluautomatska stezna glava	•	•
Mekani rukohvat	•	•
Broj baterija / punjača	0 / 0	0 / 0
Dodatna ručka	•	•
Metalni graničnik dubine	•	•
Pribor	3 SDS-Plus svrdla (8,10,12 mm), 1 šiljasto dlijeto, 1 ravno dlijeto	1 magnetni adapter bitova
Pakiranje	E-Box	E-Box
Broj artikla	45.142.65	45.139.00



AKUMULATORSKE ČEKIĆ BUŠILICE 18 V



	TE-HD 18/20 Li - Solo EXPERT	NOVO	TE-HD 18/12 Li - Solo EXPERT
PXC baterija napon / kapacitet	18 V / -		18 V / -
Vrijeme punjenja	-		-
Broj okretaja / broj udaraca / snaga udaraca	0 - 1300 min ⁻¹ / 0 - 4750 min ⁻¹ / 1,8 J		0 - 1300 min ⁻¹ / 0 - 6000 min ⁻¹ / 1,3 J
Kapacitet bušenja, beton	20 mm		12 mm
Stezna glava	SDS-plus		SDS-plus
Težina proizvoda	2,7 kg (bez baterije)		1,5 kg (bez baterije)
Motor bez četkica	-		-
Elektronska kontrola brzine	•		•
Anti-vibracijska glavna drška	-		-
Sigurnosno zaustavljanje kod preopterećenja	•		•
Pneumatski udarni mehanizam	•		•
Funkcije	4		2+1
LED svjetlo	•		•
Poluautomatska stezna glava	•		•
Mekani rukohvat	•		•
Broj baterija / punjača	0 / 0		0 / 0
Dodatna ručka	•		-
Metalni graničnik dubine	•		-
Pribor	-		1 magnetni adapter bitova
Pakiranje	E-Box Basic kovčeg		Karton
Broj artikla	45.142.60		45.139.70



4 006825 667646



4 006825 647778



AKUMULATORSKI MJEŠAČI ZA BOJU I LJPILO

Aku mješač za boju i ljepilo
TP-MX 18-2 Li Brushless



**ELEKTRONSKA
KONTROLA BRZINE**

Za rad prilagođen materijalu i primjeni

MJENJAČ S 2 BRZINE

Za maksimalan zakretni moment i veliku snagu miješanja

**ALUMINIJSKO
KUČIŠTE MJENJAČA**

Izdržljiv i robusan

**ROBUSNI PRIHVAT
ALATA ZA MIJEŠANJE**

S M14 navojem

POLAGANO POKRETANJE

Za ugodan start bez prskanja

MOTOR BEZ ČETKICA

Više snage i dulje vrijeme rada



AKUMULATORSKI MJEŠAČI ZA BOJU I LJPILO



	TP-MX 18-2 Li Brushless - Solo PROFESSIONAL	NOVO	TE-MX 18 Li - Solo EXPERT
PXC baterija napon / kapacitet	18 V / -		18 V / -
Vrijeme punjenja	-		-
Broj okretaja	0 - 450 / 0- 720 min ⁻¹		0 - 620 min ⁻¹
Prihvat alata za miješanje	M14		M14
Težina proizvoda	3,8 kg (bez baterije)		1,9 kg (bez miješalice)
Motor bez četkica	•		-
Mjenjač s 2 brzine	•		-
Elektronska kontrola brzine	•		•
Polagano pokretanje	•		•
Mekani rukohvat	•		•
Broj baterija / punjača	0 / 0		0 / 0
Pribor	1 miješalica za žbuku (Ø 120 mm)		1 miješalica za žbuku (Ø 100 mm)
Pakiranje	Karton		Karton
Broj artikla	42.587.70		42.587.60



4 006825 667639



4 006825 638196

AKUMULATORSKA KUTNE BRUSILICE

POLAGANO POKRETANJE I ZAŠTITA OD PONOVOG POKRETANJA

Osigurava povećanu sigurnost korisnika i zaštitu uređaja

POTPORNA POVRŠINA

Potporna površina sprječava prevrtanje uređaja kada se spusti - kako bi se zaštitio korisnik

ELEKTRONIKA KONSTANTNE BRZINE

Visoko opterećenje bez gubitka brzine pomoću snažne elektronike konstantne brzine

Akumulatorska kutna brusilica
TP-AG 18/125 CE Q Li



REGULACIJA BRZINE

3000 min⁻¹ do maks. 10500 min⁻¹

DODATNA RUČKA

Može se montirati u 2 položaja: Fleksibilna prilagodba u svakoj radnoj situaciji - za dešnjake i ljevake

ZAŠTITA REZNE PLOČE S BRZIM PODEŠAVANJEM

Brzo prilagođavanje radnoj poziciji bez upotrebe dodatnog alata

MATICA ZA BRZO OTPUŠTANJE

Matica za brzo otpuštanje omogućuje brzo pričvršćivanje i otpuštanje rezne ploče i drugog pribora za kutnu brusilicu bez dodatnog alata

POWER X-CHANGE LITIJ-IONSKA BATERIJA

Baterija se može koristiti za sve proizvode iz PXC obitelji

MOTOR BEZ ČETKICA

Više snage i dulje vrijeme rada

AKUMULATORSKA KUTNA BRUSILICA 230 MM

TWIN-PACK®
18V Li+ 18V Li → 36V
TECHNOLOGY

PUREPOWER
BRUSHLESS



PUREPOWER
BRUSHLESS



AXXIO 36/230 Q PROFESSIONAL

PXC baterija napon / kapacitet	2x 18 V / -
Vrijeme punjenja	-
Broj okretaja	6600 min ⁻¹
Promjer rezne ploče	230 mm
Maks. dubina reza	70 mm
Težina proizvoda	4,2 kg (bez baterije)
Motor bez četkica	•
Polagano pokretanje	•
Zaštita od ponovnog pokretanja	•
Zaštita protiv preopterećenja	•
Zaštita rezne ploče s brzim podešavanjem	•
Blokada osovine	•
Mekani rukohvat	•
Dodatna ručka	Mogućnost postavljanja u 3 položaja
Broj baterija / punjača	0 / 0
Pribor	Matica za brzo otpuštanje, ključ za pritezanje rezne ploče
Pakiranje	Karton
Broj artikla	44.311.60



4 006825 658514

AKUMULATORSKA KUTNA BRUSILICA 150 MM



	AXXIO 18/150 EXPERT
PXC baterija napon / kapacitet	18 V / -
Vrijeme punjenja	-
Broj okretaja	8500 min ⁻¹
Promjer rezne ploče	150 mm
Maks. dubina reza	40 mm
Težina proizvoda	1,5 kg (bez baterije)
Motor bez četkica	•
Polagano pokretanje	•
Zaštita od ponovnog pokretanja	•
Zaštita protiv preopterećenja	•
Zaštita rezne ploče s brzim podešavanjem	•
Blokada osovine	•
Mekani rukohvat	•
Dodatna ručka	Mogućnost postavljanja u 2 položaja
Broj baterija / punjača	0 / 0
Pribor	1 rezna ploča, 1 zaštitna rezne ploče, 1 ključ za pritezanje rezne ploče
Pakiranje	Karton
Broj artikla	44.311.44



4 006825 644494

AKUMULATORSKA KUTNA BRUSILICA 125 MM



	TP-AG 18/125 CE Q Li - Solo PROFESSIONAL	NOVO
PXC baterija napon / kapacitet	18 V / -	
Vrijeme punjenja	-	
Broj okretaja	3000 - 10500 min ⁻¹	
Promjer rezne ploče	125 mm	
Maks. dubina reza	33 mm	
Težina proizvoda	1,7 kg (bez baterije)	
Motor bez četkica	•	
Polagano pokretanje	•	
Zaštita od ponovnog pokretanja	•	
Zaštita protiv preopterećenja	•	
Zaštita rezne ploče s brzim podešavanjem	•	
Blokada osovine	•	
Mekani rukohvat	•	
Dodatna ručka	Mogućnost postavljanja u 2 položaja	
Broj baterija / punjača	0 / 0	
Pribor	Matica za brzo otpuštanje	
Pakiranje	Karton	
Broj artikla	44.311.55	



4 006825 668797

AKUMULATORSKE KUTNE BRUSILICE 125 MM



	AXXIO 18/125 Q PROFESSIONAL	AXXIO 18/125 PROFESSIONAL
PXC baterija napon / kapacitet	18 V / –	18 V / –
Vrijeme punjenja	–	–
Broj okretaja	8500 min ⁻¹	8500 min ⁻¹
Promjer rezne ploče	125 mm	125 mm
Maks. dubina reza	33 mm	33 mm
Težina proizvoda	1,4 kg (bez baterije)	1,4 kg (bez baterije)
Motor bez četkica	•	•
Polagano pokretanje	•	•
Zaštita od ponovnog pokretanja	•	•
Zaštita protiv preopterećenja	•	•
Zaštita rezne ploče s brzim podešavanjem	•	•
Blokada osovine	•	•
Mekani rukohvat	•	•
Dodatna ručka	Mogućnost postavljanja u 2 položaja	Mogućnost postavljanja u 2 položaja
Broj baterija / punjača	0 / 0	0 / 0
Pribor	Matica za brzo otpuštanje	Ključ za pritezanje rezne ploče
Pakiranje	Karton	Karton
Broj artikla	44.311.51	44.311.40



AKUMULATORSKA KUTNA BRUSILICA 115 MM



	AXXIO 18/115 Q PROFESSIONAL
PXC baterija napon / kapacitet	18 V / –
Vrijeme punjenja	–
Broj okretaja	8500 min ⁻¹
Promjer rezne ploče	115 mm
Maks. dubina reza	28 mm
Težina proizvoda	1,2 kg (bez baterije)
Motor bez četkica	•
Polagano pokretanje	•
Zaštita od ponovnog pokretanja	•
Zaštita protiv preopterećenja	•
Zaštita rezne ploče s brzim podešavanjem	•
Blokada osovine	•
Mekani rukohvat	•
Dodatna ručka	Mogućnost postavljanja u 2 položaja
Broj baterija / punjača	0 / 0
Pribor	Matica za brzo otpuštanje
Pakiranje	Karton
Broj artikla	44.311.50



AKUMULATORSKE KUTNE BRUSILICE 115 MM



	TE-AG 18/115 Q Li - Solo EXPERT NOVO	TE-AG 18/115 Li - Solo EXPERT
PXC baterija napon / kapacitet	18 V / -	18 V / -
Vrijeme punjenja	-	-
Broj okretaja	8500 min ⁻¹	8500 min ⁻¹
Promjer rezne ploče	115 mm	115 mm
Maks. dubina reza	28 mm	28 mm
Težina proizvoda	1,7 kg (bez baterije)	1,2 kg (bez baterije)
Motor bez četkica	-	-
Polagano pokretanje	•	•
Zaštita od ponovnog pokretanja	•	•
Zaštita protiv preopterećenja	•	•
Zaštita rezne ploče s brzim podešavanjem	•	•
Blokada osovine	•	•
Mekani rukohvat	•	•
Dodatna ručka	Mogućnost postavljanja u 2 položaja	Mogućnost postavljanja u 3 položaja
Broj baterija / punjača	0 / 0	0 / 0
Pribor	Matica za brzo otpuštanje, zaštita rezne ploče	Ključ za pritezanje rezne ploče
Pakiranje	Karton	Karton
Broj artikla	44.311.65	44.311.10



4 006825 663082



4 006825 602593

AKUMULATORSKE KUTNE BRUSILICE 115 MM



	TE-AG 18/115 Li - Solo Acc EXPERT	TC-AG 18/115 Li - Solo CLASSIC
PXC baterija napon / kapacitet	18 V / -	18 V / -
Vrijeme punjenja	-	-
Broj okretaja	8500 min ⁻¹	8500 min ⁻¹
Promjer rezne ploče	115 mm	115 mm
Maks. dubina reza	28 mm	28 mm
Težina proizvoda	1,2 kg (bez baterije)	1,2 kg (bez baterije)
Motor bez četkica	-	-
Polagano pokretanje	•	•
Zaštita od ponovnog pokretanja	•	•
Zaštita protiv preopterećenja	•	•
Zaštita rezne ploče s brzim podešavanjem	•	-
Blokada osovine	•	•
Mekani rukohvat	•	•
Dodatna ručka	Mogućnost postavljanja u 3 položaja	Mogućnost postavljanja u 3 položaja
Broj baterija / punjača	0 / 0	0 / 0
Pribor	1 rezna ploča, 1 brusna ploča, 1 zaštita rezne ploče, 1 ključ za pritezanje rezne ploče	Ključ za pritezanje rezne ploče
Pakiranje	E-Box Basic kovčeg	Karton
Broj artikla	44.311.23	44.311.30



4 006825 642322



4 006825 628746

AKUMULATORSKA GLODALICA U SETU

DVORUČNI NASTAVAK

Komplet sadrži dvoručni dodatak koji omogućuje vrlo precizan rad uređaja

PODEŠAVANJE DUBINE

Dubina glodanja može se jednostavno unaprijed odabrati pomoću višestupanjskog graničnika višenamjenske glave i može se precizno ponovno podešiti pomoću finog podešavanja dubine

Akumulatorska glodalica u setu
TP-RO 18 SET Li BL

ZAŠTITA OD STRUGOTINE

Štiti od strugotina u vidnom polju i tako osigurava potrebnu sigurnost rada



POWER X-CHANGE LITIJ-IONSKA BATERIJA

Baterija se može koristiti za sve proizvode iz PXC obitelji

ELEKTRONSKA KONTROLA BRZINE

Brzina snažnog motora može se kontrolirati putem upravljačke elektronike

BLOKADA OSOVINE

Omogućuje brzu i jednostavnu promjenu rezača

LED SVJETLO

Za optimalno osvetljenje radnog prostora

STEZALJKA OD 6 I 8 MM

Stezaljka stvara fleksibilnost dopuštajući upotrebu alata s promjerom osovine od 6 mm ili 8 mm

NASTAVAK ZA KANTIRANJE ZA OBRADU RUBOVA

AKUMULATORSKA GLODALICA U SETU

PURE POWER
BRUSHLESS



	TP-RO 18 Set Li Brushless - Solo PROFESSIONAL
PXC baterija napon / kapacitet	18 V / -
Vrijeme punjenja	-
Broj okretaja	10000 - 30000 min ⁻¹
Dubinski hod	40 mm / 35 mm
Maks. rez za oblikovanje	30 mm
Težina proizvoda	1,3 kg (kantiranje) / 2,4 kg (dvoručni) - bez baterije
Elektronska kontrola brzine	•
Fino podešavanje dubine reza	•
Zaštita od strugotine	•
Blokada osovine	•
Mekani rukohvat	•
Usisavanje prašine	•
Paralelni graničnik	•
Kompas	•
Dodatak	Nastavak za kantiranje + dvoručni nastavak
Promjer stezaljke	6 mm / 8 mm
Transportna torba	•
Pakiranje	Karton
Broj artikla	43.504.10



4 006825 662818

AKUMULATORSKA GLODALICA

PUREPOWER
BRUSHLESS



	TP-RO 18 Li Brushless - Solo PROFESSIONAL
PXC baterija napon / kapacitet	18 V / -
Vrijeme punjenja	-
Broj okretaja	10000 - 30000 min ⁻¹
Dubinski hod	35 mm
Maks. rez za oblikovanje	30 mm
Težina proizvoda	2,4 kg (bez baterije)
Elektronska kontrola brzine	•
Fino podešavanje dubine reza	•
Zaštita od strugotine	•
Blokada osovine	•
Mekani rukohvat	•
Usisavanje prašine	•
Paralelni graničnik	•
Kompas	•
Dodatak	Dvoručni nastavak
Promjer stezaljke	6 mm / 8 mm
Transportna torba	-
Pakiranje	Karton
Broj artikla	43.504.11



4 006825 664263

AKUMULATORSKA GLODALICA ZA KANTIRANJE

PUREPOWER
BRUSHLESS



	TP-ET 18 Li Brushless - Solo PROFESSIONAL
PXC baterija napon / kapacitet	18 V / -
Vrijeme punjenja	-
Broj okretaja	10000 - 30000 min ⁻¹
Dubinski hod	40 mm
Maks. rez za oblikovanje	30 mm
Težina proizvoda	1,3 kg (bez baterije)
Elektronska kontrola brzine	•
Fino podešavanje dubine reza	•
Zaštita od strugotine	•
Blokada osovine	•
Mekani rukohvat	•
Usisavanje prašine	•
Paralelni graničnik	•
Kompas	•
Dodatak	Nastavak za kantiranje
Promjer stezaljke	6 mm / 8 mm
Transportna torba	-
Pakiranje	Karton
Broj artikla	43.504.12



4 006825 664300

AKUMULATORSKA GLODALICA ZA UTORE



	TE-BJ 18 Li - Solo EXPERT
PXC baterija napon / kapacitet	18 V / -
Vrijeme punjenja	-
Broj okretaja	6500 min ⁻¹
Maks. dubina reza	20 mm
Podešavanje kuta nagiba	90°
Rezač kanala	Ø 100 x Ø 22 x 4 mm
Težina proizvoda	2,4 kg (bez baterije)
Beskonačno podešivi kut	•
Beskonačno podešiva visina	•
Dubina reza - brzo podešavanje	6 postavki
Blokada osovine	•
Usisavanje prašine	•
Ključ za pritezanje rezne ploče	•
Pakiranje	Karton
Broj artikla	43.506.30



AKUMULATORSKA BLANJA



	TE-PL 18/82 Li - Solo EXPERT
PXC baterija napon / kapacitet	18 V / -
Vrijeme punjenja	-
Broj okretaja	15000 min ⁻¹
Širina struganja	82 mm
Dubina struganja	2 mm
Dubina pregiba	8 mm
Težina proizvoda	2,4 kg (bez baterije)
Mekani rukohvat	•
Automatska zaštita oštrice	•
Aluminijsko podnožje blanje	•
V žljebovi	1
Izbacivanje strugotina	Jednostrano
Broj baterija / punjača	0 / 0
Paralelni graničnik	•
Graničnik dubine pregiba	•
Oštrice (reverzibilne oštrice)	1 par TCT
Pakiranje	Karton
Broj artikla	43.454.00



AKUMULATORSKJE UBODNE PILE

ELEKTRONSKA KONTROLA BRZINE

Za rad prilagođen specifičnom materijalu

Akumulatorska ubodna pila
TP-JS 18/135 Li Brushless

ROBUSNO ALUMINIJSKO UNUTARNJE KUĆIŠTE

Visokokvalitetne i stabilne komponente osiguravaju stabilnost i dugi vijek trajanja

ZAMJENA LISTA PILE BEZ DODATNOG ALATA

Brzo, jednostavno, ugodno

PARALELNI GRANIČNIK

za tačne i ravne rezove

POWER X-CHANGE

LITIJ-IONSKA BATERIJA

Baterija se može koristiti za sve proizvode iz PXC obitelji

INTEGRIRANI KLJUČ ZA PODEŠAVANJE

Za podešavanje osnovne ploče



USISAVANJE PRAŠINE

Jamči čisto radno mjesto, ugodniji rad i bolji pregled radnog komada

INTEGRIRANI KLIZNI PLASTIČNI UMETAK

Plastični klizni umetak pričvršćen na temeljnu ploču štiti posebno osjetljive radne komade

MOTOR BEZ ČETKICA

Više snage i dulje vrijeme rada



AKUMULATORSKA UBODNA PILA



	TP-JS 18/135 Li Brushless - Solo	NOVO
PXC baterija napon / kapacitet	18 V / -	
Vrijeme punjenja	-	
Broj uboda	0 - 3500 min ⁻¹	
Dubina reza (drvo / plastika / čelik)	135 / 20 / 10 mm	
Težina proizvoda	2,1 kg (bez baterije)	
Univerzalni prihvat alata	-	
Funkcija njihanja	4 postavke	
Podšavanje kuta rezanja bez alata	-	
Zamjena lista pile bez alata	•	
Priključak za usisavač	•	
LED svjetlo	•	
Funkcija puhanja prašine	•	
Vodilica reza	•	
Broj baterija / punjača	0 / 0	
Pribor	1x list pile, paralelni graničnik, štitnik od strugotina	
Pakiranje	Karton	
Broj artikla	43.212.60	



4 006825 666618

AKUMULATORSKE UBODNE PILE



	TE-JS 18/80 Li - Solo	TC-JS 18 Li - Solo
	EXPERT	CLASSIC
PXC baterija napon / kapacitet	18 V / -	18 V / -
Vrijeme punjenja	-	-
Broj uboda	0 - 2400 min ⁻¹	0 - 2700 min ⁻¹
Dubina reza (drvo / plastika / čelik)	80 / 12 / 10 mm	70 / 10 / 8 mm
Težina proizvoda	1,8 kg (bez baterije)	1,6 kg (bez baterije)
Univerzalni prihvat alata	•	-
Funkcija njihanja	4 postavke	4 postavke
Podšavanje kuta rezanja bez alata	•	-
Zamjena lista pile bez alata	•	•
Priključak za usisavač	•	•
LED svjetlo	•	-
Funkcija puhanja prašine	•	•
Vodilica reza	•	-
Broj baterija / punjača	0 / 0	0 / 0
Pribor	Paralelni graničnik, štitnik od strugotina	1x kwb list pile (drvo), štitnik od strugotina
Pakiranje	Karton	Karton
Broj artikla	43.212.00	43.212.09



4 006825 601398



4 006825 640052

AKUMULATORSKA RUČNA KRUŽNA PILA



TP-CS 18/190 Li Brushless - Solo	
PROFESSIONAL	
PXC baterija napon / kapacitet	18 V / -
Vrijeme punjenja	-
Broj okretaja	3800 min ⁻¹
List pile	Ø 190 x Ø 20/30 mm
Dubina reza 90°	65 mm
Dubina reza 45°	45 mm
Težina proizvoda	3,2 kg (bez baterije)
Motor bez četkica	•
Podešavanje bez alata (dubina / kut)	•
LED svjetlo	•
Aluminijsko podnožje pile	•
Blokada osovine	•
Dvostrano sigurnosno zaključavanje	•
Adapter za usisavanje prašine	•
Mekani rukohvat	•
Broj baterija / punjača	0 / 0
Pribor	Paralelni graničnik
Pakiranje	Karton
Broj artikla	43.312.10



AKUMULATORSKE RUČNE KRUŽNE PILE



TE-CS 18/165-1 Li - Solo		TE-CS 18/150 Li - Solo	
EXPERT		EXPERT	
PXC baterija napon / kapacitet	18 V / -	PXC baterija napon / kapacitet	18 V / -
Vrijeme punjenja	-	Vrijeme punjenja	-
Broj okretaja	4200 min ⁻¹	Broj okretaja	4200 min ⁻¹
List pile	Ø 165 x Ø 20 mm	List pile	Ø 150 x Ø 10/16 mm
Dubina reza 90°	54 mm	Dubina reza 90°	48 mm
Dubina reza 45°	35 mm	Dubina reza 45°	32 mm
Težina proizvoda	2,6 kg (bez baterije)	Težina proizvoda	2,4 kg (bez baterije)
Motor bez četkica	-	Motor bez četkica	-
Podešavanje bez alata (dubina / kut)	•	Podešavanje bez alata (dubina / kut)	•
LED svjetlo	•	LED svjetlo	•
Aluminijsko podnožje pile	•	Aluminijsko podnožje pile	•
Blokada osovine	•	Blokada osovine	•
Dvostrano sigurnosno zaključavanje	•	Dvostrano sigurnosno zaključavanje	•
Adapter za usisavanje prašine	•	Adapter za usisavanje prašine	•
Mekani rukohvat	•	Mekani rukohvat	•
Broj baterija / punjača	0 / 0	Broj baterija / punjača	0 / 0
Pribor	Paralelni graničnik	Pribor	Paralelni graničnik
Pakiranje	Karton	Pakiranje	Karton
Broj artikla	43.312.07	Broj artikla	43.312.20



AKUMULATORSKA MINI RUČNA KRUŽNA PILA



	TE-CS 18/89 Li - Solo EXPERT
PXC baterija napon / kapacitet	18 V / -
Vrijeme punjenja	-
Broj okretaja	3500 min ⁻¹
List pile	Ø 89 x Ø 10 mm
Dubina reza 90°	28 mm
Težina proizvoda	1,8 kg (bez baterije)
Motor bez četkica	-
Podesiva dubina uvrtnja	•
LED svjetlo	-
Aluminijsko podnožje pile	•
Blokada osovine	•
Dvostrano sigurnosno zaključavanje	-
Adapter za usisavanje prašine	•
Mekani rukohvat	•
Broj baterija / punjača	0 / 0
Pribor	2 lista pile (drvo/plastika), paralelni graničnik
Pakiranje	Karton
Broj artikla	43.311.00



AKUMULATORSKA VIŠENAMJENSKA PILA



PUREPOWER
BRUSHLESS



TP-AP 18/28 Li Brushless - Solo	
PROFESSIONAL	
PXC baterija napon / kapacitet	18 V / -
Vrijeme punjenja	-
Broj uboda	0 - 2500 min ⁻¹
Visina uboda	28 mm
Dubina reza (drvo / čelik)	200 / 12 mm
Debljina lista pila	0,8 - 1,6 mm
Težina proizvoda	2,0 kg (bez baterije)
Motor bez četkica	•
Zamjena lista pile bez alata	•
Podešavanje graničnika pile bez alata	•
Antivibracijska funkcija	•
Okretna glavna ručka	•
Broj baterija / punjača	0 / 0
Pribor	1 kwk list pile (drvo)
Pakiranje	Karton
Broj artikla	43.263.10



AKUMULATORSKE VIŠENAMJENSKE PILE



TE-AP 18/26 Li - Solo		TE-AP 18/22 Li - Solo	
EXPERT		EXPERT	
PXC baterija napon / kapacitet	18 V / -	18 V / -	-
Vrijeme punjenja	-	-	-
Broj uboda	0 - 2600 min ⁻¹	0 - 2600 min ⁻¹	-
Visina uboda	26 mm	22 mm	-
Dubina reza (drvo / čelik)	180 / 12 mm	100 / 6 mm	-
Debljina lista pila	0,7 - 1,8 mm	0,6 - 1,6 mm	-
Težina proizvoda	2,1 kg (bez baterije)	1,6 kg (bez baterije)	-
Motor bez četkica	-	-	-
Zamjena lista pile bez alata	•	•	-
Podešavanje graničnika pile bez alata	•	•	-
Antivibracijska funkcija	•	-	-
Okretna glavna ručka	-	-	-
Broj baterija / punjača	0 / 0	0 / 0	-
Pribor	1 list pile (drvo)	1 list pile (drvo)	-
Pakiranje	Karton	Karton	-
Broj artikla	43.262.90	43.263.00	-



AKUMULATORSKE POTEZNE PREKLOPNE PILE



TWIN-PACK®
18V Li+ 18V Li > 36V
TECHNOLOGY



Ilustrativna slika



Ilustrativna slika

	TE-SM 36/10 L Li - Solo EXPERT NOVO	TE-SM 36/210 Li - Solo EXPERT
PXC baterija napon / kapacitet	2x 18 V / -	2x 18 V / -
Broj okretaja	3800 min ⁻¹	3800 min ⁻¹
List pile	Ø 254 x Ø 30 mm	Ø 210 x Ø 30 mm
Broj zuba	40	40
Raspon zakretanja	-47° do +47°	-47° do +47°
Podšavanje kuta lista pile	0° do 45° na lijevo	0° do 45° na lijevo
Maks. širina reza 90°	340 x 85 mm	310 x 65 mm
Težina proizvoda	15,7 kg (bez baterije)	12,6 kg (bez baterije)
Laser	•	•
LED svjetlo	•	•
Polagano pokretanje	•	•
Zaštita protiv preopterećenja	•	•
X-Tend potpora radnog komada s graničnikom	•	•
Stezni uređaj	•	•
Broj baterija / punjača	0 / 0	0 / 0
Precizni TCT list pile	1 kom	1 kom
Vreća za sakupljanje piljevine	•	•
Broj artikla	43.008.85	43.008.80



4 006825 665239



4 006825 641523

AKUMULATORSKA PREKLOPNA PILA



Ilustrativna slika

	TE-MS 18/210 Li - Solo EXPERT
PXC baterija napon / kapacitet	18 V / -
Broj okretaja	3000 min ⁻¹
List pile	Ø 210 x Ø 30 mm
Broj zuba	40
Raspon zakretanja	-47° do +47°
Podšavanje kuta lista pile	0° do 45° na lijevo
Maks. širina reza 90°	120 x 60 mm
Težina proizvoda	7,8 kg (bez baterije)
Laser	•
LED svjetlo	•
Polagano pokretanje	•
Zaštita protiv preopterećenja	•
X-Tend potpora radnog komada s graničnikom	•
Stezni uređaj	•
Broj baterija / punjača	0 / 0
Precizni TCT list pile	1 kom
Vreća za sakupljanje piljevine	•
Broj artikla	43.008.90



4 006825 628074

AKUMULATORSKA STOLNA KRUŽNA PILA

TWIN-PACK[®]
18V + 18V > 36V
TECHNOLOGY

	TE-TS 36/210 Li - Solo EXPERT
PXC baterija napon / kapacitet	2x 18 V / -
Broj okretaja	3800 min ⁻¹
List pile	Ø 210 x Ø 30 mm
Broj zuba	40
Podešavanje kuta lista pile	0° do 45° na lijevo
Visina reza 90°	70 mm
Visina reza 45°	45 mm
Visina Veličina stola	467 x 480 mm
Maks. kapacitet rezanja desno	625 mm
Težina proizvoda	13,1 kg (bez baterije)
Proširenje stola	Desno, na izvlačenje
Polagano pokretanje	•
Zaštita protiv preopterećenja	•
Broj baterija / punjača	0 / 0
Precizni TCT list pile	1 kom
Paralelni graničnik, stezanje s obje strane	•
Kutni graničnik	•
Palica za guranje	•
Broj artikla	43.404.50



4 006825 647365

AKUMULATORSKE TRAČNE PILE



	TE-MB 18/127 U Li - Solo EXPERT NOVO	TE-MB 18/127 Li - Solo EXPERT NOVO
PXC baterija napon / kapacitet	18 V / -	18 V / -
Brzina lista pile	120 m/min	120 m/min
List pile	1141 x 13 x 0,65 mm	1141 x 13 x 0,65 mm
Broj zuba	10/14 ZPZ kombinirano ozubljenje	10/14 ZPZ kombinirano ozubljenje
Podešavanje kuta lista pile	0° do 47° na lijevo	-
Kapacitet rezanja 90°	115 x 127 mm	115 x 127 mm
Kapacitet rezanja maks. 45°	40 x 40 mm	-
Težina proizvoda	12,7 kg (bez baterije)	5,5 kg (bez baterije)
Zamjena lista pile bez alata	•	•
Podešavanje ručke bez alata	•	•
LED svjetlo	•	•
Radni stol s mehanizmom za brzo otpuštanje	•	-
Broj baterija / punjača	0 / 0	0 / 0
Pribor	2x 10/14 ZPZ list pile	2x 10/14 ZPZ list pile
Broj artikla	45.042.15	45.042.16



4 006825 662078



4 006825 663105

AKUMULATORSKI
VIŠENAMJENSKI ALATI

	VARRITO EXPERT	TC-MG 18 Li - Solo CLASSIC
PXC baterija napon / kapacitet	18 V / -	18 V / -
Vrijeme punjenja	-	-
Broj oscilacija / broj okretaja	22000 - 40000 min ⁻¹ / 11000 - 20000 min ⁻¹	22000 - 40000 min ⁻¹ / 11000 - 20000 min ⁻¹
Kut oscilacija	3,2°	3,2°
Veličina brusnog papira	93 x 93 x 93 mm	93 x 93 x 93 mm
Težina proizvoda	1,0 kg (bez baterije)	0,9 kg (bez baterije)
Elektronska kontrola brzine	•	•
Mekani rukohvat	•	•
Zaključavanje brzog otpuštanja alata	•	-
Magnetni držač alata	•	•
Specijalni prihvat baterije za smanjenje vibracija	•	•
Broj baterija / punjača	0 / 0	0 / 0
Trokutasti nosač brusnog papira	•	•
Brusni papir	3x P60, 3x P80, 3x P120	3x P60, 3x P80, 3x P120
Strugač	•	•
Uranjajući list pile	1x drvo/plastika, 1x metal	1x drvo/plastika
Segmentni list pile	1x drvo/plastika/neobojeni metal, 1x pločice	1x drvo/plastika/neobojeni metal
Šesterokutni ključ	-	•
Pakiranje	Karton	Karton
Broj artikla	44.651.60	44.651.70



4 006825 618648



4 006825 628593

AKUMULATORSKE
BRUSILICE ZA ZIDOVE

Ilustrativna slika



	TP-DWS 18/225 Li Brushless - Solo PROFESSIONAL	TP-DW 18/225 Li - Solo PROFESSIONAL
PXC baterija napon / kapacitet	18 V / -	18 V / -
Broj okretaja	600 - 1200 min ⁻¹	600 - 1200 min ⁻¹
Veličina brusnog papira, Ø	225 mm	225 mm
Duljina brusilice	-	110 - 165 cm
Duljina crijeva	1,3 - 4,5 m	1,3 - 4,5 m
Težina proizvoda	2,4 kg (bez baterije)	3,6 kg (bez baterije)
Okretna brusna ploča	-	•
Elektronska kontrola brzine	•	•
Pričvršćivanje na čičak	•	•
Sklopiva, teleskopska drška	-	•
Potporna noga	-	•
Broj baterija / punjača	0 / 0	0 / 0
Brusni papir	2x P60, 2x P80, 2x P120 + brusna mreža P120	2x P60, 2x P80, 2x P120 + brusna mreža P120
Vreća za prašinu	•	•
Pakiranje	Karton	E-Box
Broj artikla	42.599.95	42.599.90



4 006825 670011



4 006825 647037

AKUMULATORSKA TRAČNA BRUSILICA



	TP-BS 18/457 Li Brushless - Solo PROFESSIONAL NOVO
PXC baterija napon / kapacitet	18 V / -
Brzina brusne trake	120 - 250 m/min
Područje brušenja	75 x 126
Veličina brusne trake	75 x 457
Težina proizvoda	2,5 kg
Motor bez četkica	•
Podešavanje brusne trake	•
Zamjena brusne trake bez upotrebe alata	•
Usisavanje prašine	Kutija za prašinu i adapter za usisavanje prašine
Mekani rukohvat	•
Broj baterija / punjača	0 / 0
Brusna traka	3x P80
Pakiranje	Karton
Broj artikla	44.662.70



AKUMULATORSKE VIBRACIONE BRUSILICE



	TE-OS 18/230 Li - Solo EXPERT	TC-OS 18/187 Li - Solo CLASSIC
PXC baterija napon / kapacitet	18 V / -	18 V / -
Brzina oscilacija	14000 - 22000 min ⁻¹	24000 min ⁻¹
Krug oscilacija, Ø	2,5 mm	2,0 mm
Veličina brusnog papira	230 x 115 mm	187 x 94 mm
Težina proizvoda	1,6 kg (bez baterije)	1,1 kg (bez baterije)
Elektronska kontrola brzine	•	-
Pričvršćivanje na čitak	•	•
Hvataljke za brusni papir	•	•
Mekani rukohvat	•	•
Usisavanje prašine	Vrećica za prašinu i adapter za usisavanje prašine	Vrećica za prašinu i adapter za usisavanje prašine
Broj baterija / punjača	0 / 0	0 / 0
Brusni papir	1x P60, 1x P80, 1x P120	1x P80
Adapter za usisavanje prašine	•	•
Pakiranje	Karton	Karton
Broj artikla	44.607.20	44.607.25



AKUMULATORSKA VIŠENAMJENSKA BRUSILICA



	TE-OS 18/150 Li - Solo EXPERT
PXC baterija napon / kapacitet	18 V / -
Brzina oscilacija	24000 min ⁻¹
Krug oscilacija, Ø	1,6 mm
Veličina brusnog papira	150 x 150 x 100 mm
Težina proizvoda	0,8 kg (bez baterije)
Elektronska kontrola brzine	-
Pričvršćivanje na čičak	•
Hvataljke za brusni papir	-
Mekani rukohvat	•
Usisavanje prašine	Kutija za prašinu
Broj baterija / punjača	0 / 0
Brusni papir	3x P120, 3x P240
Adapter za usisavanje prašine	•
Pakiranje	Karton
Broj artikla	44.607.08



4 006825 651218

AKUMULATORSKA EKSCENTRIČNA BRUSILICA



	TE-RS 18 Li - Solo EXPERT
PXC baterija napon / kapacitet	18 V / -
Brzina oscilacija	14000 - 22000 min ⁻¹
Krug oscilacija, Ø	2,0 mm
Brusni papir, Ø	125 mm
Težina proizvoda	1,2 kg (bez baterije)
Elektronska kontrola brzine	•
Pričvršćivanje na čičak	•
Usisavanje prašine	Vrećica za prašinu i adapter za usisavanje prašine
Mekani rukohvat	•
Broj baterija / punjača	0 / 0
Brusni papir	1x P80
Pakiranje	Karton
Broj artikla	44.620.10



4 006825 618341

AKUMULATORSKI ALAT ZA BRUŠENJE I GRAVIRANJE



	TE-MT 18/34 Li - Solo EXPERT	NOVO
PXC baterija napon / kapacitet	18 V / -	
Broj okretaja	5000 - 34000 min ⁻¹	
Čahura za stezanje, Ø	1,6 / 2,4 / 3,2 mm	
Duljina fleksibilne osovine	92 cm	
Težina proizvoda	1,4 kg (bez baterije)	
Elektronska kontrola brzine	•	
Blokada osovine	•	
Držač pribora u kućištu	•	
Zidni nosač	•	
Mekani rukohvat	•	
Broj baterija / punjača	0 / 0	
Pribor	57 komada	
Remen za nošenje	•	
Pakiranje	Karton	
Broj artikla	44.193.60	



4 006825 668728

AKUMULATORSKA KUTNA POLIRKA

PUREPOWER
BRUSHLESS



	CE-CP 18/180 Li E - Solo EXPERT
PXC baterija napon / kapacitet	18 V / -
Broj okretaja	500 - 3000 min ⁻¹
Promjer diska	180 mm
Težina proizvoda	1,3 kg (bez baterije)
Motor bez četkica	•
Pogodno za brušenje / oštrenje	•
On/Off prekidač	•
Ergonomski mekani rukohvat	•
Elektronska kontrola brzine	•
Blokada osovine	•
Prihvatač brusnog papira na čičak	•
Broj baterija / punjača	0 / 0
Sintetička navlaka	1 kom
Spužvasti nastavak	1 kom
Brusni papir (P60, P80, P120)	po 1 kom od svakog
Pakiranje	Karton
Broj artikla	20.933.20



AKUMULATORSKA POLIRKA



	CE-CB 18/254 Li - Solo CAR EXPERT
PXC baterija napon / kapacitet	18 V / -
Broj okretaja	2500 min ⁻¹
Promjer diska	254 mm
Težina proizvoda	1,9 kg (bez baterije)
On/Off prekidač	•
Ergonomski mekani rukohvat	•
Broj baterija / punjača	0 / 0
Tekstilna navlaka	1 kom
Sintetička navlaka	1 kom
Pakiranje	Karton
Broj artikla	20.933.01



AKUMULATORSKI PIŠTO LJ ZA PRSKANJE BOJE



	TC-SY 18/60 Li - Solo CLASSIC
PXC baterija napon / kapacitet	18 V / -
Vrijeme punjenja	-
Dostavni kapacitet	650 ml/min
Kapacitet spremnika	800 ml
Maks. viskoznost	60 DIN-sek
Težina proizvoda	1,3 kg (bez baterije)
Motor bez četkica	-
Obrada	Lakovi, premazi
Odvojiva glava za raspršivanje	•
Kontrola dostavnog kapaciteta boje	•
Mlaz boje	Vertikalni, horizontalni i okrugli mlaz
Mekani rukohvat	•
Mlaznice	Ø 2,0 mm, 2,5 mm
Četka za čišćenje i igla	•
Spremnik za testiranje viskoziteta	•
Spremnik za boju s poklopcem	800 ml
Pakiranje	Karton
Broj artikla	42.600.25



4 006825 656343

AKUMULATORSKI PIŠTO LJ ZA SILIKON



	TE-SG 18/10 Li - Solo EXPERT
PXC baterija napon / kapacitet	18 V / -
Brzina potiskivanja	0 - 10 mm/s
Snaga potiska	2000 N
Unutarnji promjer	51 mm
Veličina uloška	310 ml
Težina proizvoda	1,9 kg (bez baterije)
Motor bez četkica	-
Podesiva brzina potiskivanja	•
Automatski povratni mehanizam	•
Gumene podloge	•
Mekani rukohvat	•
Broj baterija / punjača	0/0
Pribor	Igla za čišćenje
Pakiranje	Karton
Broj artikla	45.222.50



4 006825 661187

AKUMULATORSKJE KLAMERICE

FIXETTO

ERGONOMSKA RUČKA S MEKANIM RUKOHVATOM

Za dobro prijanjanje i udoban rad

PRESSAIR TEHNOLOGIJA

PressAir predstavlja: bez održavanja, bez dodatnih troškova i opreme

Akumulatorski pištolj za čavle
FIXETTO 18/50 N

GUMIRANE STRANE

Štiti radni predmet

OBOSTRANA LED RASVJETA

Za osvjtljavanje radnog područja

PODEŠAVANJE DUBINE

Za precizan rad

SIGURNOSNI PREKIDAČ

Zaštita od slučajnog izbacivanja čavlića

KOPČA ZA REMEN

Za dodatnu udobnost korisnika

REGULATOR IZBACIVANJA

Za pojedinačno ili serijsko izbacivanje

SPREMNIK S INDIKATOROM RAZINE

Pružuje stalni pregled preostale količine u spremniku



AKU KLAMERICA / AKU PIŠTOLJ ZA ČAVLE

PRESSAIR
TECHNOLOGY



	FIXETTO 18/38 S PROFESSIONAL NOVO	FIXETTO 18/50 N PROFESSIONAL NOVO
PXC baterija napon / kapacitet	18 V / -	18 V / -
Maks. radna brzina	60 u min	60 u min
Duljina spajalica	10 - 38 mm	-
Duljina čavlića	-	15 - 50 mm
Težina proizvoda	2,9 kg (bez baterije)	2,8 kg (bez baterije)
Podšavanje dubine	•	•
Serijsko izbacivanje	•	•
Spremnik s indikatorom razine	•	•
Kopča za remen	•	•
Sigurnosni nos	•	•
Mekani rukohvat	•	•
Broj baterija / punjača	0/0	0/0
Čavlići	-	500 kom
Spajalice	500 kom	-
Pakiranje	Karton	Karton
Broj artikla	42.577.85	42.577.95



4 006825 668483



4 006825 666885

AKUMULATORSKA KLAMERICA



	TE-CN 18 Li - Solo EXPERT
PXC baterija napon / kapacitet	18 V / -
Maks. radna brzina	20 po min
Duljina spajalica	16 - 22 mm
Duljina čavlića	15 - 32 mm
Težina proizvoda	2,1 kg (bez baterije)
Podšavanje dubine	•
Serijsko izbacivanje	-
Spremnik s indikatorom razine	•
Kopča za remen	•
Sigurnosni nos	•
Mekani rukohvat	•
Broj baterija / punjača	0 / 0
Čavlići	300 kom
Spajalice	300 kom
Pakiranje	Karton
Broj artikla	42.577.90



4 006825 653786

AKUMULATORSKI RADIO



Bluetooth®

	TC-RA 18 Li BT - Solo CLASSIC
PXC baterija napon / kapacitet	18 V / -
Frekvencija FM	87,5 - 108 MHz
Frekvencija AM	522 - 1620 kHz
Memorija stanica (AM/FM)	10 / 10
Težina proizvoda	0,7 kg (bez baterije)
Hibridna funkcija	-
LCD zaslon	•
Vanjska antena	•
Bluetooth	•
AUX priključak	-
USB funkcija punjenja	-
Ručka za nošenje	•
Štražnje spremište za mobitel i sl.	•
Broj baterija / punjača	0 / 0
Pakiranje	Karton
Broj artikla	34.080.17



4 006825 651492

AKUMULATORSKI ZVUČNIK



Bluetooth®

	TC-SR 18 Li BT - Solo CLASSIC
PXC baterija napon / kapacitet	18 V / -
Snaga	2x 3,0 W
Maks. glasnoća	85 dB
Težina proizvoda	0,3 kg (bez baterije)
AUX priključak	•
Bluetooth	•
USB funkcija punjenja	•
Broj baterija / punjača	0 / 0
Pakiranje	Kartonska kutija s prozorom
Broj artikla	45.141.50



4 006825 644531

AKU SVJETILJKA / AKU REFLEKTORI



	TE-CL 18/2500 LiAC - Solo EXPERT	TE-CL 18/2000 LiAC - Solo EXPERT	TC-CL 18/1800 Li - Solo CLASSIC
PXC baterija napon / kapacitet	18 V / -	18 V / -	18 V / -
Napon	12 V	100 - 240 V ~ 50-60 Hz	-
Dužina kabela	3 m	2 m	-
Jačina svjetlosti	1000 lm / 2500 lm	1000 lm / 1500 lm / 2000 lm	1800 lm
Izvor svjetlosti	7 LED	20 LED	1 LED
Vrijeme rada	3 h (4,0 Ah)	4 h (4,0 Ah)	4 h (4,0 Ah)
Težina proizvoda	0,6 kg (bez baterije)	1,3 kg (bez baterije)	1,3 kg (bez baterije)
Podšavanje nagiba	-	•	•
Podesivi svjetlosni snop	-	-	-
Kuka za pričvršćivanje	-	•	•
Navoj za stativ	1/4"	1/4" / 5/8"	-
Mekani rukohvat	•	•	-
Broj baterija / punjača	0 / 0	0 / 0	0 / 0
Pakiranje	Karton	Karton	Karton
Broj artikla	45.141.45	45.141.14	45.141.15



AKUMULATORSKA SVJETILJKA



USB ADAPTER ZA PXC BATERIJU



	TC-CL 18 Li H - Solo CLASSIC	TC-CP 18 Li USB - Solo CLASSIC
PXC baterija napon / kapacitet	18 V / -	18 V / -
Napon	-	2
Dužina kabela	-	1,0 A
Jačina svjetlosti	280 lm	2,1 A
Izvor svjetlosti	1 LED	0,1 kg (bez baterije)
Vrijeme rada	8 h (1,5 Ah)	0 / 0
Težina proizvoda	0,2 kg (bez baterije)	Karton
Podšavanje nagiba	•	Broj artikla
Podesivi svjetlosni snop	-	45.141.20
Kuka za pričvršćivanje	•	
Navoj za stativ	-	
Mekani rukohvat	•	
Broj baterija / punjača	0 / 0	
Pakiranje	Karton	
Broj artikla	45.141.30	



AKUMULATORSKI PUHAČ



	TE-CB 18/180 Li - Solo EXPERT
PXC baterija napon / kapacitet	18 V / -
Protok puhanja zraka; postavka 1 2	130 km/h 180 km/h
Težina proizvoda	1,0 kg (bez baterije)
Broj baterija / punjača	0 / 0
Nastavci za napuhavanje	3 kom
Pakiranje	Karton
Broj artikla	34.080.01



4 006825 631746

AKUMULATORSKI VENTILATOR



	GE-CF 18/2200 Li EXPERT NOVO
PXC baterija napon / kapacitet	18 V / -
Broj okretaja	1200 / 1700 / 2200 rpm
Snaga vjetra	15000 m/h
Promjer ventilatora	180 mm
Težina proizvoda	1,2 kg (bez baterije)
360° podešavanje	•
Ručka za nošenje	•
Različite mogućnosti pričvršćivanja	•
Broj artikla	34.080.35



4 006825 665253

AKU PIŠTOLJ ZA VRUĆE LJEPLJENJE



	TE-CG 18 Li - Solo EXPERT
PXC baterija napon / kapacitet	18 V / -
Vrijeme zagrijavanja	120 s
Maks. temperatura	170 °C
Patrone za ljepljenje	11 mm
Težina proizvoda	0,3 kg (bez baterije)
LED indikator razine temperature	•
LED svjetlo	•
Broj baterija / punjača	0 / 0
Pribor	5 patrone (d=200 mm), plosnata mlaznica
Pakiranje	Karton
Broj artikla	45.222.00



4 006825 641202

AKUMULATORSKI FEN ZA VRUĆI ZRAK



	TE-HA 18 Li - Solo EXPERT
PXC baterija napon / kapacitet	18 V / -
Temperatura postavka 1 2	350 °C 550 °C
Količina zraka	200 l/min
Težina proizvoda	0,6 kg (bez baterije)
LED zaslon	•
Zaštita od pregrijavanja	•
Prekidač za konstantni rad	•
Mehanički izbacivač mlaznice	•
Broj baterija / punjača	0 / 0
Redukcijska mlaznica	•
Mlaznica sa širokim mlazom	•
Reflektorska mlaznica	•
Pakiranje	Karton
Broj artikla	45.205.00



4 006825 647730

SISTEMSKI KOVČEZI E-CASE



SPUŽVASTI MREŽASTI UMETAK



SPUŽVASTI UMETAK



SET PLASTIČNIH PREGRADA

KOMPATIBILNOST

Sve veličine E-Case kutija i kovčega su međusobno kompatibilni i mogu se povezati

E-CASE-SYSTEM

SKLOPIVE RUČKE

Dvije sklopive ergonomske ručke – gornja i bočna – osiguravaju udobnost pri nošenju

DIZAJN KOJI ŠTITI OD PRSKANJA VODE

Kako bi zaštitili alate i pribor, E-Case je opremljen posebnom zaštitom protiv prskanja vode koja također odbija prljavštinu i prašinu

MATERIJAL VISOKE KVALITETE

E-Case je izrađen od visokokvalitetnog polipropilena, koji osigurava otpornost na toplinu, čvrstoću i otpornost na udarce

TELESKOPSKA, ŠIROKA RUČKA

Za jednostavan transport



ODSTOJNICE

Kako biste spriječili uklještenje ruke

ROBUSNE BRAVE

Omogućuje sigurno zaključavanje kovčega

SUSTAV ZAKLJUČAVANJA

Praktičan sustav zaključavanja za spajanje naslaganih kovčega osigurava jednostavno skladištenje i transport

VELIKI, GUMIRANI KOTAČI

Veliki (Ø 15 cm), gumirani kotači osiguravaju ugodno ponašanje na bilo kojoj površini



ROBUSTAN, MOGUĆNOST SLAGANJA I POVEZIVANJA



SISTEMSKI KOVČEZI E-CASE



	E-Case S-F	E-Case M NOVO
Opseg isporuke	1x sistemski kovčeg + 2x spužvasti umetak za uređaje	1x E-Case M + 1x uložak za ručni alat
Unutarnje dimenzije	415 x 280 x 95 mm	415 x 280 x 250 mm
Vanjske dimenzije	444 x 330 x 131 mm	444 x 330 x 295 mm
Nosivost	25 kg	90 kg
Težina proizvoda	1,7 kg	2,9 kg
Sistem slaganja i zaključavanja	•	•
Zaštita od prskanja	•	•
Na zaključavanje	•	•
Teleskopska ručka + kotači	-	-
Spužvasti umetak	1x umetak za poklopac, 1x umetak za podnožje	-
Plastične pregrade	-	-
Uložak za ručni alat	-	•
Broj artikla	45.400.11	45.400.21



4 006825 653991



4 006825 667721

SISTEMSKI KOVČEZI E-CASE



	E-Case L	E-Case Tower
Opseg isporuke	1x E-Case L + 1x uložak za ručni alat + 2x odstojnik	1x E-Case S + 2x spužvasti umetak, 1x E-Case S + 1x set plastičnih pregrada, 1x E-Case L + 1x uložak za ručni alat + 2x odstojnik
Unutarnje dimenzije	415 x 273 x 320 mm	415 x 280 x 95 mm (E-Case S), 415 x 273 x 320 mm (E-Case L)
Vanjske dimenzije (uklj. teleskopska ručka)	444 x 406 x 355 mm	444 x 368 x 700 mm
Nosivost	120 kg	120 kg
Težina proizvoda	6,3 kg	10,1 kg
Sistem slaganja i zaključavanja	•	•
Zaštita od prskanja	•	•
Na zaključavanje	•	•
Teleskopska ručka + kotači	•	•
Spužvasti umetak	-	1x umetak za poklopac, 1x umetak za podnožje
Plastične pregrade	-	2x duga pregrada, 3x srednja pregrada, 4x kratka pregrada
Uložak za ručni alat	•	•
Broj artikla	45.400.14	45.400.15



4 006825 660562



4 006825 660609

PRIBOR SISTEMSKOG KOVČEGA E-CASE



	Set plastičnih pregrada	Spužvasti mrežasti umetak
Pogodan za	E-Case S-F	E-Case S-F
Opseg isporuke	2x duga pregrada, 3x srednja pregrada, 4x kratka pregrada	1x prilagodljivi spužvasti mrežasti umetak
Broj artikla	45.400.12	45.400.13



25 kg

Maks. nosivost jednog kovčega pri nošenju s bočnom ručkom



90 kg

Maks. nosivost nekoliko E-Case kovčega pri nošenju s gornjom ručkom



120 kg

Maks. ukupna nosivost E-Case L + naslagani kovčezi



1000 kg

Maks. dopušteno opterećenje na najniže naslagan E-Case kovčeg

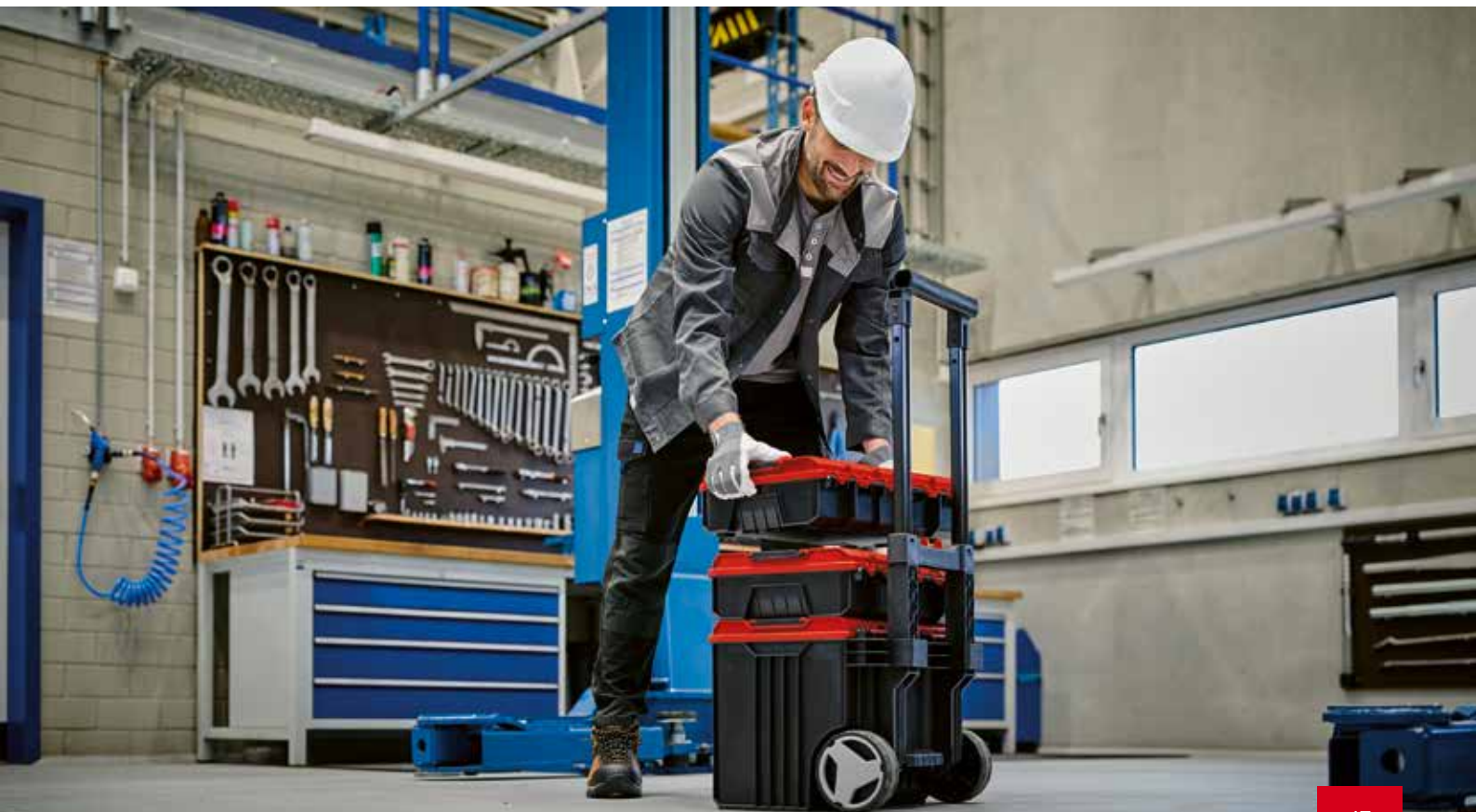

PRIBOR – KOVČEZI



	E-Box L70	E-Box M55	E-Box S35
Opseg isporuke	1 univerzalni kovčeg	1 univerzalni kovčeg	1 univerzalni kovčeg
Unutarnje dimenzije	670 x 190 x 300 mm	510 x 327 x 124 mm	310 x 250 x 89,5 mm
Vanjske dimenzije	700 x 250 x 350 mm	550 x 400 x 150 mm	350 x 330 x 110 mm
Nosivost	50 kg	30 kg	12 kg
Težina proizvoda	4,1 kg	3,0 kg	1,6 kg
Sistem slaganja i zaključavanja	-	-	-
Zaštita od prskanja	•	•	•
Na zaključavanje	-	-	-
Spužvasti umetak	•	•	•
Plastične pregrade	-	-	-
Broj artikla	45.300.54	45.300.49	45.300.45



PRIBOR – TORBE



	Einhell Bag 45/22	Einhell Bag 45/29
Opseg isporuke	1 univerzalna torba	1 univerzalna torba
Unutarnje dimenzije	390 x 200 x 190 mm	420 x 270 x 200 mm
Vanjske dimenzije	450 x 220 x 350 mm	450 x 290 x 220 mm
Nosivost	15 kg	20 kg
Težina proizvoda	0,9 kg	1,2 kg
Broj artikla	45.300.37	45.300.74



AKUMULATORSKI USISAVAČI SUHO/MOKRO

POWER X-CHANGE LITIJ-IONS KA BATERIJA

Zahvaljujući baterijskom pogonu, usisavač se može koristiti bilo gdje - bez gnjavaže oko zapetljanih strujnih kabela. Baterija se može koristiti u svim uređajima Power X-Change obitelji

ECO/BOOST NAČIN RADA

Dostupne su 2 brzine za optimalno korištenje baterije

DRŽAČ PRIBORA

TP-VC 36/30 S Auto odmah je spreman za upotrebu zahvaljujući praktičnom držaču pribora izravno na uređaju

TWIN-PACK®

18V + 18V 36V

TECHNOLOGY

TWIN-PACK TEHNOLOGIJA

Upotreba 2x 18 V Power X-Change baterije za još više snage

Akumulatorski usisavač suho/mokro TP-VC 36/30 S Auto

VRLO OTPORNO USISNO CRIJEVO

Usisno crijevo dužine 2,50 m fleksibilno je i istovremeno vrlo čvrsto

FUNKCIJA POVEZIVANJA

Usisavanje prašine bez kableske veze zahvaljujući funkciji povezivanja. Usisavanje počinje automatski kada pokrenete alat, npr. akumulatorsku ubodnu pilu

SPREMNIK OD NEHRĐAJUĆEG ČELIKA

Spremnik od nehrđajućeg čelika nudi dovoljan kapacitet od 30 l

VELIKI KOTAČI I KOTAČIĆI

Uz 2 velika kotača i 2 kotačića, usisavač za suho/mokro usisavanje može se jednostavno voditi kroz radionicu, garažu ili dnevnu sobu

AKUMULATORSKI USISAVAČI SUHO/MOKRO



	TP-VC 36/30 S Auto - Solo PROFESSIONAL	TE-VC 36/30 Li S - Solo EXPERT
PXC baterija napon / kapacitet	2x 18 V / -	2x 18 V / -
Usisna snaga	150 mbar / 100 mbar (BOOST / ECO)	150 mbar / 100 mbar (BOOST / ECO)
Spremnik	Nehrđajući čelik, 30 l	Nehrđajući čelik, 30 l
Usisno crijevo duljina / promjer	250 cm / 36 mm	250 cm / 36 mm
Razina buke	76 dB(A)	76 dB(A)
Težina proizvoda	8,0 kg (bez baterije)	8,0 kg (bez baterije)
Sustav automatskog pokretanja alata	•	-
Broj brzina	2	2
Vrlo otporno usisno crijevo	•	•
Broj baterija / punjača	0 / 0	0 / 0
Usisna cijev	Teleskopska, od nehrđajućeg čelika	Teleskopska, od nehrđajućeg čelika
Nastavci	Uski nastavak, usisna četka, podni nastavak	Uski nastavak, usisna četka, podni nastavak
Filter	1x spužvasti filter, 1x dugotrajni filter, 1x vrećica za prašinu	1x spužvasti filter, 1x dugotrajni filter, 1x vrećica za prašinu
Pakiranje	Karton	Karton
Broj artikla	23.471.43	23.471.40



4 006825 660067



4 006825 635874

AKUMULATORSKI USISAVAČI SUHO/MOKRO



	TE-VC 36/25 Li S - Solo EXPERT	TC-VC 18/20 Li S - Solo CLASSIC
PXC baterija napon / kapacitet	2x 18 V / -	18 V / -
Usisna snaga	150 mbar / 100 mbar (BOOST / ECO)	80 mbar
Spremnik	Nehrđajući čelik, 25 l	Nehrđajući čelik, 20 l
Usisno crijevo duljina / promjer	250 cm / 36 mm	150 cm / 36 mm
Razina buke	76 dB(A)	72 dB(A)
Težina proizvoda	7,0 kg (bez baterije)	3,6 kg (bez baterije)
Sustav automatskog pokretanja alata	-	-
Broj brzina	2	1
Vrlo otporno usisno crijevo	-	-
Broj baterija / punjača	0 / 0	0 / 0
Usisna cijev	2-dijelna, od nehrđajućeg čelika	3-dijelna, plastika
Nastavci	Uski nastavak, usisna četka, podni nastavak	Uski nastavak, usisna četka, podni nastavak
Filter	1x spužvasti filter, 1x dugotrajni filter, 1x vrećica za prašinu	1x spužvasti filter, 1x dugotrajni filter, 1x vrećica za prašinu
Pakiranje	Karton	Karton
Broj artikla	23.471.70	23.471.30



4 006825 656527



4 006825 625998

AKUMULATORSKI USISAVAČI SUHO/MOKRO



	TC-VC 18/15 Li - Solo CLASSIC	TE-VC 18/10 Li - Solo EXPERT
PXC baterija napon / kapacitet	18 V / -	18 V / -
Usisna snaga	80 mbar	90 mbar
Spremnik	Plastika, 15 l	Plastika, 10 l
Usisno crijevo duljina / promjer	150 cm / 36 mm	200 cm / 36 mm
Razina buke	72 dB(A)	72 dB(A)
Težina proizvoda	3,2 kg (bez baterije)	3,1 kg (bez baterije)
Sustav automatskog pokretanja alata	-	-
Broj brzina	1	1
Vrlo otporno usisno crijevo	-	-
Broj baterija / punjača	0 / 0	0 / 0
Usisna cijev	3-dijelna, plastika	-
Nastavci	Uski nastavak, podni nastavak	2x 2u1 nastavak (uski+četka / presvlake+podni)
Filter	1x spužvasti filter, 1x filter vrećica, 1x vrećica za prašinu	1x spužvasti filter, 1x filter vrećica, 1x vrećica za prašinu
Pakiranje	Karton	Karton
Broj artikla	23.471.45	23.471.60



4 006825 652086



4 006825 640274

AKUMULATORSKI ŠTAPNI USISAVAČ

KOMPAKTNA I LAGANA KONSTRUKCIJA

Za usisavanje bez umaranja

2u1 DIZAJN

Donosi fleksibilnost i kombinira sve prednosti štapnog usisavača s prednostima ručnog usisavača za udoban i neumoran rad u cijeloj kući i oko nje

TEHNOLOGIJA BRZOG PUNJENJA

Omogućuje kratko vrijeme punjenja i nesmetan rad

NEOGRANIČENO VRIJEME RADA BEZ KABELA

Zahvaljujući akumulatorskom sistemu Power X-Change u kombinaciji s tehnologijom brzog punjenja

MOTORIZIRANI PODNI NASTAVAK S 2 NAČINA RADA

Prilagodba svakoj situaciji u samo dva koraka, ECO za rukovanje normalnom prljavštinom s maksimalnim vremenom rada, BOOST za rukovanje tvrdokornom prljavštinom s maksimalnom snagom usisavanja, npr. na tepisima

AKUMULATORSKI ŠTAPNI USISAVAČ



ECO I BOOST MOD

Prilagodite snagu usisavanja bilo kojoj površini

BEZ VREĆICE ZA PRAŠINU

Lako se prazni dodirom tipke, nema dodatnih troškova za filtere

TROSTRUKI FILTERSKI SUSTAV

Trostruki filterski sustav uključujući ciklonsku tehnologiju s predfilterom, perivim dugotrajnim filterom, filterom motora i ciklonskim separatorom osigurava čisti izlazni zrak i učinkovito usisavanje s velikom usisnom snagom

UKLJUČUJE OPSEŽNI PRIBOR

Uključeno: Zidni nosač za skladištenje koji štedi prostor, 2-u-1 kombinirani nastavak i fleksibilni nastavak za pukotine za teško dostupna mjesta



4x LED REFLEKTORA

Pružava savršene rezultate čišćenja čak i na tamnim mjestima kao što je ispod kreveta ili namještaja

GUMENI KOTAČI

Zaštita poda i tihi rad zahvaljujući gumenim kotačima

	TE-SV 18 Li - Solo EXPERT
PXC baterija napon / kapacitet	18 V / -
Kapacitet spremnika	0,6 l
Težina proizvoda	1,1 kg (bez baterije)
Broj brzina	2
Broj baterija / punjača	0 / 0
Nastavci	1x motorizirani podni, 1x 2u1 univerzalni, 1x fleksibilni
Filter	3x filterski sustav: predfilter, izmjenjivi i perivi dugotrajni filter, filter motora
Zidni nosač	•
Gumeni kotači	•
LED svjetlo	•
Pakiranje	Karton
Broj artikla	23.471.80

2 M PRODUŽNO CRIJEVO DOSTUPNO KAO PRIBOR. OVAJ I OSTALI PRIBOR ZA TE-SV 18 Li MOŽETE PRONAĆI NA STR. 159



4 006825 659061

AKUMULATORSKI RUČNI USISAVAČI



	TE-HV 18/06 Li - Solo EXPERT NOVO	TE-VC 18 Li - Solo EXPERT
PXC baterija napon / kapacitet	18 V / -	18 V / -
Usisna snaga	72 mbar / 50 mbar (BOOST / ECO)	42 mbar
Kapacitet usisavanja	17,0 l/s	13,5 l/s
Spremnik	Plastika, 0,60 l	Plastika, 0,54 l
Usisno crijevo duljina / promjer	70,0 cm / 32 mm	46,5 cm / 32 mm
Razina buke	74 dB(A)	68 dB(A)
Težina proizvoda	1,0 kg (bez baterije)	0,9 kg (bez baterije)
Broj brzina	2	1
Broj baterija / punjača	0 / 0	0 / 0
Nastavci	Podni nastavak, uski nastavak, usisna četka (po 1x)	Podni nastavak, uski nastavak, usisna četka (po 1x)
Filter	Perivi sintetički filter (1x)	Perivi sintetički filter (1x)
Zidni nosač	•	•
Pakiranje	Karton	Karton
Broj artikla	23.471.90	23.471.20



AKUMULATORSKI USISAVAČ PEPELA



	TE-AV 18/15 Li C - Solo EXPERT
PXC baterija napon / kapacitet	18 V / -
Usisna snaga	100 mbar
Spremnik	Nehrđajući čelik, 15 l
Usisno crijevo duljina / promjer	120 cm / 35 mm
Razina buke	75 dB(A)
Težina proizvoda	3,1 kg (bez baterije)
Tehnologija čišćenja filtera	•
Ručka za nošenje	•
Namotavanje kabela	•
Kolut za crijevo	•
Skladištenje pribora	•
Broj baterija / punjača	0 / 0
Dugotrajni filter	•
Pakiranje	Karton
Broj artikla	23.517.00



AKUMULATORSKI ČISTAČ PROZORA

BRILLIANTO

GUMENI NASTAVAK

Patentirani jednodijelni silikonski gumeni nastavak ostavlja čiste prozore bez tragova

IZMJENJIVA ČETKA

Za više mogućih upotreba (vidi pribor)

MEKANI RUKOHVAT

Za udobno i sigurno držanje u ruci

SPREMNİK

Jednostavno pražnjenje i čišćenje potpuno uklonjivog spremnika

Akumulatorski čistač prozora
BRILLIANTO

DOBRA RASPODJELA TEŽINE

Pozicioniranje baterije ispod uređaja osigurava uravnoteženu raspodjelu težine, a time i udoban rad

HORIZONTALNA, OKOMITA I VODORAVNA UPORABA

Jedinstveni dizajn četke s kućištem omogućuje ove primjene

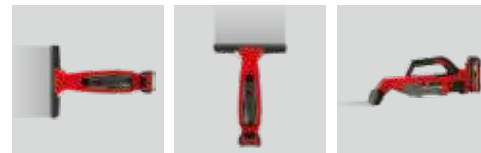

18 V SNAGE

Za vrlo visoku učinkovitost i najbolje rezultate čišćenja

NEOGRANIČENO VRIJEME RADA

Zahvaljujući korištenju Power X-Change baterije, te brzom i jednostavnom zamjeni baterija

ZIDNI NOSAČ

Zidni nosač koji se lako sastavlja osigurava jednostavno, praktično skladištenje koje štedi prostor



AKUMULATORSKI ČISTAČ PROZORA



TELESKOPSKA DRŠKA DOSTUPNA KAO PRIBOR.
OVAJ I OSTALI PRIBOR ZA BRILLIANTO MOŽETE PRONAĆI NA STR. 159



	BRILLIANTO EXPERT	NOVO
PXC baterija napon / kapacitet	18 V / -	
Spremnik za prljavu vodu	100 ml	
Širina četke	280 mm	
Težina proizvoda	0,7 kg (bez baterije)	
Broj baterija / punjača	0 / 0	
Uključeno u isporuku	Srednje široka usisna četka, zidni nosač, bočica s raspršivačem i jastučićem od mikrovlakana	
Pakiranje	Karton	
Broj artikla	34.371.00	



4 006825 670196

AKUMULATORSKI VISOKOTLAČNI ČISTAČ

HYPRESSO

LAGAN I MOBILAN

Zbog male težine i funkcije usisavanja idealan je i za mobilnu upotrebu

ECO NAČIN RADA

Za dulje trajanje baterije

4-U-1 MLAZNICA

Rotacijska mlaznica (za posebno snažno čišćenje), točkasti mlaz, široki mlaz i ravni mlaz, npr. za zamagljivanje/zalijevanje biljaka

Akumulatorski visokotlačni čistač
HYPRESSO 18/24

POWER X-CHANGE

LITIJ-IONSKA BATERIJA

Baterija se može koristiti za sve proizvode iz PXC obitelji

OTPORAN NA PRSKANJE

Uključuje gumeni poklopac za zaštitu baterije

BRZA SPOJNICA ZA CRIJEVO

Za priključak na slavinu za vodu ili priključak usisnog crijeva

OPSEŽAN PRIBOR

Set pribora s 2 produžne cijevi, usisnim crijevom od 5 m uključujući filter vode, 4-smjernom mlaznicom, bocom za deterdžent za pranje, vrećicom za pohranu i zaštitom od prskanja



HYPRESSO 18/24 s montiranim nastavkom

AKUMULATORSKI VISOKOTLAČNI ČISTAČ



	HYPRESSO 18/24 EXPERT	NOVO
PXC baterija napon / kapacitet	18 V / -	
Maks. radni tlak	24 bara	
Maks. količina protoka	240 l/h	
Duljina usisnog crijeva	500 cm	
Težina proizvoda	2,5 kg (bez baterije)	
Eco način rada	•	
Mogućnost spremanja pribora	•	
Broj baterija / punjača	0 / 0	
4-u-1 višenamjenska mlaznica	•	
Spremnik za deterđent za pranje	•	
Pakiranje	Karton	
Silikonski poklopac za bateriju	•	
Broj artikla	41.401.30	



4 006825 667349



AKUMULATORSKI STROJ ZA METENJE



	TE-SW 18/610 Li - Solo EXPERT
PXC baterija napon / kapacitet	18 V / -
Maks. radno područje	1800 m ² /h
Radna širina	610 mm
Spremnik	20 l
Broj bočnih četka	2
Težina proizvoda	10,3 kg (bez baterije)
Ručka za vođenje podesiva po visini	•
Sklopiva ručka za vođenje	•
Broj baterija / punjača	0 / 0
Broj artikla	23.520.40



4 006825 649246

AKUMULATORSKI ČISTAČ ODVODA



	TE-DA 18/760 Li - Solo EXPERT
PXC baterija napon / kapacitet	18 V / -
Broj okretaja	0 - 560 min ⁻¹
Duljina spirale	7,6 m
Promjer spirale	7 mm
Za čišćenje cijevi promjera	16 - 55 mm
Težina proizvoda	3,7 kg (bez baterije)
Rotacija (desno / lijevo)	•
Rotacija (naprijed / nazad)	•
Pocinčana spirala	•
LED svjetlo	•
Otvor za dovod i odvod vode	•
Mehanizam za zaključavanje spirale	•
Broj baterija / punjača	0 / 0
Broj artikla	45.141.60



4 006825 664409

6U1 AKUMULATORSKI HIBRIDNI KOMPRESORI

HIBRIDNA FUNKCIJA

Može se koristiti u pokretu s kabelom za napajanje ili baterijom

PRIKAZ TLAKA

Digitalni dvoredni prikaz tlaka za tlak visokotlačne pumpe

FUNKCIJA RUČNOG NAPUHAVANJA

Prekidač za napuhavanje (visoki tlak) bez unaprijed podešenog tlaka

SVJETLO

Integrirano svjetlo za hitne slučajeve, npr. u slučaju puknuća gume noću

RUČNO PODEŠAVANJE TLAKA

Željeni tlak za visokotlačnu pumpu može se postaviti na 11 bara, funkcija automatskog isključivanja kada se dosegne željeni tlak

VIŠENAMJENSKI UREĐAJ

Visokotlačno pumpanje, niskotlačno pumpanje i niskotlačno usisavanje sa samo jednim uređajem

PRAKTIČNO

Kabeli i crijeva za napajanje nalaze se izravno na uređaju



6u1 aku hibridni kompresor
PRESSITO 18/25 Hybrid

PRIBOR

S integriranim 5-dijelnim setom adaptera za lopte, gume i zračne madrace, kompresor se može koristiti na razne načine

POWER X-CHANGE

LITIJ-IONIJSKA BATERIJA

Baterija se može koristiti za sve proizvode iz PXC obitelji

PRESSITO

6U1 AKUMULATORSKI HIBRIDNI KOMPRESORI



	PRESSITO 18/25 Hybrid EXPERT NOVO	PRESSITO EXPERT
PXC baterija napon / kapacitet	18 V / -	18 V / -
Napon	220 - 240 V ~ 50/60 Hz	220 - 240 V ~ 50 Hz
Usisna snaga	25 l/min	21 l/min
Izlazna snaga na 0 4 7 bara	20 l/min 12 l/min 10 l/min	16 l/min 10 l/min 8 l/min
Maks. radni tlak	11 bara	11 bara
Težina proizvoda	2,5 kg (bez baterije)	2,1 kg (bez baterije)
Hibridna funkcija	•	•
Digitalni prikaz tlaka	•	•
Svjetlo	•	-
Prekidač za visokotlačnu pumpu	•	-
Spremište za kabel	•	•
Skladištenje pribora	•	•
Broj baterija / punjača	0 / 0	0 / 0
Crijeva	Visokotlačno crijevo (71 cm), niskotlačno crijevo (160 cm)	Visokotlačno crijevo (71 cm), niskotlačno crijevo (31 cm)
Set adaptera	•	•
Pakiranje	Karton	Karton
Broj artikla	40.204.30	40.204.60



4 006825 667318



4 006825 627244

3U1 AKUMULATORSKI KOMPRESORI



	PRESSITO 18/25 EXPERT NOVO	PRESSITO 18/21 EXPERT
PXC baterija napon / kapacitet	18 V / -	18 V / -
Usisna snaga	25 l/min	21 l/min
Izlazna snaga na 0 4 7 bara	17 l/min 11 l/min 9 l/min	14 l/min 9 l/min 6 l/min
Maks. radni tlak	11 bara	10,5 bara
Težina proizvoda	2,5 kg (bez baterije)	2,1 kg (bez baterije)
Prekidač za visokotlačnu pumpu	•	•
Digitalni prikaz tlaka	•	•
Skladištenje pribora	•	•
Broj baterija / punjača	0 / 0	0 / 0
Crijeva	Visokotlačno crijevo (71 cm), niskotlačno crijevo (160 cm)	Visokotlačno crijevo (71 cm), niskotlačno crijevo (31 cm)
Set adaptera	•	•
Pakiranje	Karton	Karton
Broj artikla	40.204.20	40.204.67



AKUMULATORSKI KOMPRESORI



	TE-AC 36/6/8 Li OF Set - Solo EXPERT	TE-AC 36/8 Li OF Set - Solo EXPERT
PXC baterija napon / kapacitet	2x 18 V / -	2x 18 V / -
Usisna snaga	130 l/min	130 l/min
Izlazna snaga na 0 4 7 bara	90 l/min 55 l/min 38 l/min	90 l/min 55 l/min 38 l/min
Kapacitet spremnika	6 l	Bez spremnika
Maks. radni tlak	8 bara	8 bara
Težina proizvoda	9,7 kg (bez baterije)	5,4 kg (bez baterije)
Redukcija tlaka	•	-
Skladištenje pribora	•	•
Broj baterija / punjača	0 / 0	0 / 0
Crijevo za komprimirani zrak	•	•
Adapter za ispuhivanje	•	•
Nastavak za pumpanje guma	•	•
Set adaptera	•	•
Pakiranje	Karton	Karton
Broj artikla	40.204.50	40.204.40



AKUMULATORSKI AUTO KOMPRESOR



	CE-CC 18 Li-Solo CAR EXPERT
PXC baterija napon / kapacitet	18 V / -
Izlazna snaga na 0 4 7 bara	12 l/min 10 l/min 8 l/min
Maks. radni tlak	11 bara
Dugo crijevo za komprimirani zrak	60 cm
Težina proizvoda	0,8 kg (bez baterije)
Digitalni prikaz tlaka	•
Mogućnost podešavanja željenog tlaka	•
Funkcija automatskog isključivanja	•
Ručno napuhavanje	•
Skladištenje pribora	•
Pogodan za	Gume za automobile, gume za bicikle, male igračke, sport i oprema za plažu
Broj baterija / punjača	0 / 0
Set adaptera	3-dijelni
Pakiranje	Karton
Broj artikla	20.710.10



AKUMULATORSKA ZRAČNA PUMPA



	CE-AP 18 Li-Solo CAR EXPERT
PXC baterija napon / kapacitet	18 V / -
Maks. izlazna snaga	670 l/min
Maks. radni tlak	0,05 bara
Težina proizvoda	0,4 kg (bez baterije)
Pogodno za ventilaciju	•
Prekidač za zatvaranje	•
LED svjetlo	•
Pogodan za	Čamci za napuhavanje, zračni madraci, ostali artikli za slobodno vrijeme
Broj baterija / punjača	0 / 0
Adapter ventila	2x
Pakiranje	Karton
Broj artikla	20.701.10



AKUMULATORSKI STROJ ZA REZANJE PLOČICA



	TE-TC 18/115 Li - Solo EXPERT
PXC baterija napon / kapacitet	18 V / -
Broj okretaja	3800 min ⁻¹
Visina reza 90° 45°	24 mm 16 mm
Rezna ploča	Ø 115 x Ø 22,2 mm
Podešavanje kuta lista pile	0° do 45° na lijevo
Težina proizvoda	3,4 kg (bez baterije)
Spremnik za vodu	•
Paralelni graničnik	•
Kutni graničnik	•
Broj baterija / punjača	0 / 0
Broj artikla	43.011.90





TVOJ IZBOR. ŠTO ZNAČI MULTI-AH?

Zahvaljujući tehnologiji MULTI-Ah, promjena baterije od 5 Ah na bateriju od 8 Ah vrlo je jednostavna pritiskom na gumb. Baterija od 5 Ah ima 3x dulji ukupni vijek trajanja i prikladna je za lagane primjene (npr. aku svjetiljka ili aku odvijač). Baterija od 8 Ah prikladna je za maksimalno vrijeme rada kod intenzivnijih primjena (npr. kod akumulatorskih kosilica ili akumulatorskih usisavača suho/ mokro).

5 Ah **300%**
+ Dulji vijek trajanja¹⁾

8 Ah **60%**
+ Dulje vrijeme rada²⁾

¹⁾ u usporedbi s bilo kojom običnom litij-ionskom baterijom

²⁾ u usporedbi s baterijom od 5 Ah

PRIBOR – BATERIJE



	5-8 Ah Multi-Ah Power X-Change Plus baterija NOVO	4-6 Ah Multi-Ah Power X-Change Plus baterija
Opseg isporuke	1 baterija	1 baterija
PXC baterija napon / kapacitet	18 V / 8,0 Ah ili 5,0 Ah (ovisno o području primjene)	18 V / 6,0 Ah ili 4,0 Ah (ovisno o području primjene)
Snaga baterije	Maks. 1350 W	Maks. 1350 W
Težina proizvoda	1,04 kg	1,02 kg
Broj artikla	45.116.00	45.115.02



4 006825 665055



4 006825 644210



PRIBOR – BATERIJE

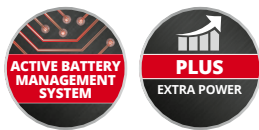

	5,2 Ah Power X-Change Plus baterija	4,0 Ah Power X-Change Plus baterija	3,0 Ah Power X-Change Plus baterija
Opseg isporuke	1 baterija	1 baterija	1 baterija
PXC baterija napon / kapacitet	18 V / 5,2 Ah	18 V / 4,0 Ah	18 V / 3,0 Ah
Snaga baterije	Maks. 1260 W	Maks. 900 W	Maks. 900 W
Težina proizvoda	0,89 kg	0,58 kg	0,57 kg
Broj artikla	45.114.37	45.115.53	45.115.01



4,0 Ah BATERIJA – 4,0 Ah PLUS BATERIJA. KOJA JE RAZLIKA?

Prelaskom na novi format ćelija „21700“ (21 mm promjer, 70,0 mm duljina), naše najnovije Power X-Change baterije dobivaju najbolju kombinaciju snage / vremena rada i težine.

Zašto? S ovom tehnologijom ćelija, ista snaga i vrijeme rada mogući su s pet umjesto dosadašnjih deset ćelija.

Prednost? Nove baterije su 12% lakše i 13% kompaktnije nego prije - sa 100% snage i duljim vremenom rada.

Rezultat: lagani svestrani uređaji za aplikacije visokih performansi, kao što su npr. akumulatorske lančane pile.

4,0 Ah



4,0 Ah

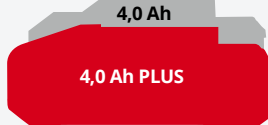

4,0 Ah PLUS



13% kompaktnija *)

12% lakša *)

100% snage

* u usporedbi s konvencionalnom baterijom od 4,0 Ah



Skenirajte QR kod kako biste dobili informacije o podržanim projektima

PROJEKTI ZAŠTITE KLIME S „CLIMATEPARTNER“.

Kako bismo kompenzirali emisije CO2 naših Power X-Change baterija, podržavamo projekte zaštite klime u područjima održive proizvodnje električne energije i zaštite mora. Emisije CO2 baterija 3,0 Ah Plus, 4,0 Ah Plus, 4-6 Ah Multi-Ah Plus i 5-8 Ah Multi-Ah Plus kompenziraju se, od proizvodnje do prodaje.

Projekti zaštite klime odabrani putem „ClimatePartner“ certificirani su prema međunarodnim standardima, npr. Verified Carbon Standard (VCS) ili Gold Standard (GS) i redovito ih provjeravaju neovisne treće strane. Time se osigurava i redovito potvrđuje klimatski učinak projekata (ušteda CO2).

Detaljne informacije dostupne su putem QR koda.

PRIBOR – BATERIJE



	4,0 Ah Power X-Change baterija	2,5 Ah Power X-Change baterija	2,0 Ah Power X-Change baterija
Opseg isporuke	1 baterija	1 baterija	1 baterija
PXC baterija napon / kapacitet	18 V / 4,0 Ah	18 V / 2,5 Ah	18 V / 2,0 Ah
Snaga baterije	Maks. 900 W	Maks. 720 W	Maks. 450 W
Težina proizvoda	0,65 kg	0,46 kg	0,40 kg
Broj artikla	45.113.96	45.115.16	45.113.95



PRIBOR – BATERIJE



	2x 5,2 Ah Power X-Change Twin-Pack	2x 4,0 Ah Power X-Change Twin-Pack	2x 2,5 Ah Power X-Change Twin-Pack
Opseg isporuke	2 Baterije	2 Baterije	2 Baterije
PXC baterija napon / kapacitet	2x 18 V / 5,2 Ah	2x 18 V / 4,0 Ah	2x 18 V / 2,5 Ah
Snaga baterije	Maks. 2x 1260 W	Maks. 2x 900 W	Maks. 2x 720 W
Težina proizvoda	1,78 kg	1,32 kg	0,92 kg
Broj artikla	45.115.26	45.114.89	45.115.24



PXC-PRIBOR



	Zidni nosač za baterije	Zaštitna kutija za baterije NOVO
Opseg isporuke	2 zidna nosača, 4 vijka, 4 tiple	1 zaštitna kutija za baterije
Prikladno za (baterije)	Sve 18 V Power X-Change baterije	Sve 18 V Power X-Change baterije
Upotrebljivo za (uređaje)	-	BRILLIANTO, HYPRESSO 18/24, TE-DA 18/760 Li, GE-WS 18/10 Li
Posebna karakteristika	Baterije sjedaju na svoje mjesto i fiksiraju se u bilo kojem položaju	Štiti bateriju od prašine i vlage
Broj artikla	45.141.55	41.401.51



PRIBOR – PUNJAČI



	2x2 Power X-Quattrocharger 4 A	Power X-Twincharger 3 A
Opseg isporuke	1 punjač	1 punjač
Prikladno za	18 V Power X-Change baterije	18 V Power X-Change baterije
Struja punjenja	4 A	3 A
Višestruki punjač	• 4 utora za punjenje - istovremeno punjenje 2 baterije	• 2 utora za punjenje - istovremeno punjenje 2 baterije
Pojačani način rada	-	-
Integrirani zidni nosač	-	•
Izvor napajanja	220 - 240 V ~ 50-60 Hz	220 - 240 V ~ 50-60 Hz
Broj artikla	45.121.02	45.120.69



4 006825 649536



4 006825 629729

PRIBOR – PUNJAČI



	Power X-Boostcharger 8 A <small>NOVO</small>	Power X-Boostcharger 6 A	Power X-Fastcharger 4 A
Opseg isporuke	1 punjač	1 punjač	1 punjač
Prikladno za	18 V Power X-Change baterije	18 V Power X-Change baterije	18 V Power X-Change baterije
Struja punjenja	3 - 8 A	3 - 6 A	4 A
Višestruki punjač	-	-	-
Pojačani način rada	•	•	-
Integrirani zidni nosač	•	•	•
Izvor napajanja	220 - 240 V ~ 50-60 Hz	220 - 240 V ~ 50-60 Hz	220 - 240 V ~ 50-60 Hz
Broj artikla	45.121.55	45.120.64	45.121.03



4 006825 670554



4 006825 629019



4 006825 650228

**U POKRETU STE I NEMATE
UTIČNICU PRI RUCI?
S EINHELLOM
NEMA PROBLEMA!**



	Power X-Car Charger 3 A
Opseg isporuke	1 punjač
Prikladno za	18 V Power X-Change baterije
Struja punjenja	3 A
Višestruki punjač	-
Pojačani način rada	-
Elektronika za zaštitu akumulatora automobila	•
Integrirani zidni nosač	•
Izvor napajanja	12 V istosmjerna struja
Broj artikla	45.121.13



4 006825 655377

POWER X-CAR PUNJAČ

ELEKTRONIKA ZA ZAŠTITU
AKUMULATORA AUTOMOBILA

1. Akumulator automobila je slab:

Proces punjenja se zaustavlja i oba indikatorska svjetla trepću naizmjenično - štiti akumulator automobila od daljnjeg pražnjenja. **Automobil se još uvijek može pokrenuti u ovom stanju.**

2. Prazan akumulator automobila:

Svjetla indikatora se gase - štiti akumulator automobila od dubokog pražnjenja.



Tablica vremena punjenja baterije na stranici 69.

PRIBOR – STARTER SETOVI



	2x 4,0 Ah PXC Twincharger Starter Kit	2x 3,0 Ah PXC Twincharger Starter Kit
Opseg isporuke	2 baterije + 1 Power X-Twincharger - dupli punjač 3 A	2 baterije + 1 Power X-Twincharger - dupli punjač 3 A
PXC baterija napon / kapacitet	2x 18 V / 2x 4,0 Ah	2x 18 V / 2x 3,0 Ah
Snaga baterije	Maks. 2x 900 W	Maks. 2x 900 W
Struja punjenja	3 A	3 A
Izvor napajanja	220 - 240 V ~ 50-60 Hz	220 - 240 V ~ 50-60 Hz
Višestruki punjač	• 2 otvora za punjenje - istovremeno punjenje 2 baterije	• 2 otvora za punjenje - istovremeno punjenje 2 baterije
Pojačani način rada	-	-
Integrirani zidni nosač	•	•
Broj artikla	45.121.12	45.120.83



PRIBOR – STARTER SETOVI



	4-6 Ah PXC Boostcharger Starter Kit
Opseg isporuke	1 baterija + 1 Power X-Boostcharger 6 A NOVO
PXC baterija napon / kapacitet	18 V / 6,0 Ah ili 4,0 Ah (ovisno o području primjene)
Snaga baterije	Maks. 1350 W
Struja punjenja	6 A
Izvor napajanja	220 - 240 V ~ 50-60 Hz
Višestruki punjač	-
Pojačani način rada	•
Integrirani zidni nosač	•
Broj artikla	45.121.43



Ready To Go predstavlja: Baterija je spremna za upotrebu. Sada može ostati u punjaču za potpuno, impulsno punjenje do 100%.

PRIBOR – STARTER SETOVI



	5,2 Ah PXC Fastcharger Starter Kit	4,0 Ah Power X-Change Starter Kit	2,5 Ah Power X-Change Starter Kit
Opseg isporuke	1 baterija + 1 Power X-Fastcharger 4 A	1 baterija + 1 Power X-Charger 3 A	1 baterija + 1 Power X-Charger 3 A
PXC baterija napon / kapacitet	18 V / 5,2 Ah	18 V / 4,0 Ah	18 V / 2,5 Ah
Snaga baterije	Maks. 1260 W	Maks. 900 W	Maks. 720 W
Struja punjenja	4 A	3 A	3 A
Izvor napajanja	220 - 240 V ~ 50-60 Hz	220 - 240 V ~ 50-60 Hz	220 - 240 V ~ 50-60 Hz
Višestruki punjač	-	-	-
Pojačani način rada	-	-	-
Integrirani zidni nosač	•	•	•
Broj artikla	45.121.14	45.120.42	45.120.97



VODIČ ZA BATERIJE – VRIJEME RADA S BATERIJOM

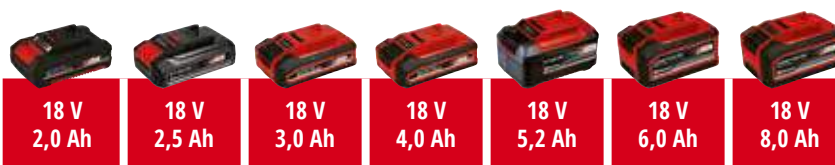

			18 V 2,0 Ah	18 V 2,5 Ah	18 V 3,0 Ah	18 V 4,0 Ah	18 V 5,2 Ah	18 V 6,0 Ah	18 V 8,0 Ah
Akumulatorske bušilice	TP-CD 18/60 Li Brushless		350 kom	440 kom	530 kom	700 kom	920 kom	1060 kom	1400 kom
	TP-CD 18/50 Li Brushless		320 kom	400 kom	480 kom	640 kom	830 kom	960 kom	1280 kom
	TP-CD 18/40 Li Brushless		300 kom	380 kom	450 kom	600 kom	780 kom	900 kom	1200 kom
	TE-CD 18/45 3X-Li		320 kom	400 kom	480 kom	640 kom	830 kom	960 kom	1280 kom
	TE-CD 18/40 Li		305 kom	380 kom	460 kom	610 kom	770 kom	920 kom	1220 kom
	TE-CD 18/2 Li		240 kom	300 kom	360 kom	480 kom	625 kom	720 kom	960 kom
	TC-CD 18/35 Li		295 kom	366 kom	440 kom	590 kom	760 kom	880 kom	1180 kom
Akumulatorske udarne bušilice	TP-CD 18/60 Li-i Brushless		350 kom	440 kom	530 kom	700 kom	920 kom	1060 kom	1400 kom
	TP-CD 18/50 Li-i Brushless		320 kom	400 kom	480 kom	640 kom	830 kom	960 kom	1280 kom
	TE-CD 18/48 Li-i		310 kom	380 kom	460 kom	620 kom	780 kom	910 kom	1230 kom
Akumulatorski udarni odvijači	TP-CI 18 Li Brushless		280 kom	350 kom	420 kom	560 kom	730 kom	840 kom	1120 kom
	TE-CI 18/1 Li		185 kom	230 kom	280 kom	370 kom	520 kom	560 kom	740 kom
	IMPAXXO 18/400		55 kom	68 kom	80 kom	110 kom	140 kom	160 kom	220 kom
	IMPAXXO 18/230		100 kom	125 kom	150 kom	200 kom	260 kom	300 kom	400 kom
Akumulatorski odvijač za knauf	TE-DY 18 Li		1100 kom	1350 kom	1600 kom	2200 kom	2800 kom	3300 kom	4400 kom
Akumulatorska udarna bušilica	TC-ID 18 Li		60 kom	75 kom	90 kom	120 kom	156 kom	180 kom	240 kom
Akumulatorske čekić bušilice	HEROCCO 36/28		79 rupa	105 rupa	126 rupa	169 rupa	222 rupa	276 rupa	338 rupa
	HEROCCO 18/20		335 kom 87 rupa	417 kom 108 rupa	500 kom 130 rupa	670 kom 174 rupa	870 kom 225 rupa	1000 kom 260 rupa	1340 kom 348 rupa
	TE-HD 18/20 Li		39 kom	49 kom	60 kom	78 kom	103 kom	117 kom	156 kom
	TE-HD 18/12 Li		185 kom 45 rupa	226 kom 57 rupa	270 kom 82 rupa	360 kom 96 rupa	474 kom 140 rupa	540 kom 166 rupa	720 kom 182 rupa
Akumulatorski mješaći boje i ljepila	TP-MX 18-2 Li Brushless		14 min 11 min	18 min 14 min	21 min 16 min	28 min 22 min	37 min 28 min	42 min 32 min	56 min 44 min
	TE-MX 18 Li		20 min 16 min	25 min 20 min	30 min 24 min	40 min 32 min	52 min 42 min	60 min 48 min	80 min 64 min
Akumulatorske kutne brusilice	AXXIO 36/230 Q		32 kom	41 kom	48 kom	62 kom	81 kom	93 kom	124 kom
	AXXIO 18/150 Li		33 kom	37 kom	46 kom	61 kom	85 kom	92 kom	122 kom
	TP-AG 18/125 CE Q Li		37 kom	46 kom	55 kom	73 kom	94 kom	109 kom	145 kom
	AXXIO 18/125 Q		29 kom	37 kom	52 kom	63 kom	92 kom	121 kom	126 kom
	AXXIO 18/125		33 kom	37 kom	46 kom	61 kom	85 kom	92 kom	122 kom

VODIČ ZA BATERIJE - VRIJEME RADA S BATERIJOM

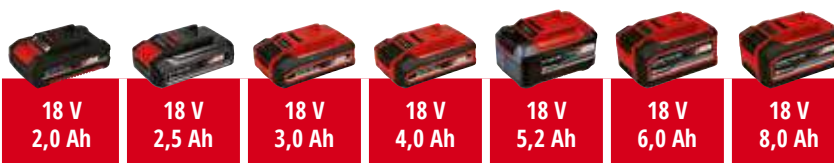





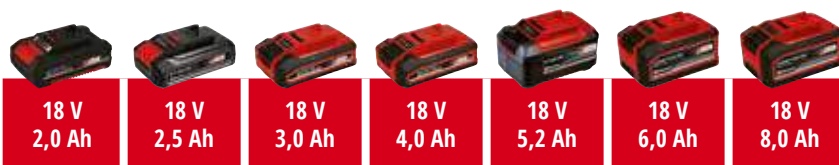





















			18 V 2,0 Ah	18 V 2,5 Ah	18 V 3,0 Ah	18 V 4,0 Ah	18 V 5,2 Ah	18 V 6,0 Ah	18 V 8,0 Ah
Akumulatorske kutne brusilice	AXXIO 18/115 Q		29 kom	37 kom	52 kom	63 kom	92 kom	121 kom	126 kom
	TE-AG 18/115 Q Li		29 kom	43 kom	52 kom	63 kom	92 kom	104 kom	133 kom
	TE-AG 18/115 Li		20 kom	25 kom	30 kom	40 kom	60 kom	70 kom	80 kom
	TC-AG 18/115 Li		20 kom	25 kom	30 kom	40 kom	60 kom	70 kom	80 kom
Akumulatorska glodalica	TP-RO 18 Li Brushless		29 m	37 m	44 m	58 m	77 m	88 m	118 m
Akumulatorska glodalica za rubove	TP-ET 18 Li Brushless		29 m	37 m	44 m	58 m	77 m	88 m	118 m
Akumulatorska glodalica za utore	TE-BJ 18 Li		283 kom	353 kom	424 kom	566 kom	735 kom	840 kom	1132 kom
Akumulatorska blanja	TE-PL 18/82 Li		25 m	28 m	37 m	48 m	58 m	78 m	96 m
Akumulatorske ubodne pile	TE-JS 18/80 Li		9,5 m	11 m	14 m	20 m	30 m	32 m	40 m
	TC-JS 18 Li		9,5 m	11 m	14 m	20 m	30 m	32 m	40 m
Akumulatorske ručne kružne pile	TE-CS 18/190 Li Brushless		24 m	30 m	37 m	49 m	63 m	73 m	98 m
	TE-CS 18/165-1 Li		33 m	40 m	49 m	64 m	82 m	98 m	128 m
	TE-CS 18/150 Li		30 m	38 m	45 m	60 m	78 m	90 m	120 m
Akumulatorska mini ručna kružna pila	TE-CS 18/89 Li		36 m	50 m	57 m	72 m	104 m	120 m	144 m
Akumulatorske višenamjenske pile	TP-AP 18/28 Li Brushless		226 kom	332 kom	417 kom	556 kom	723 kom	834 kom	1112 kom
	TE-AP 18/26 Li		207 kom	259 kom	320 kom	414 kom	572 kom	640 kom	828 kom
	TE-AP 18/22 Li		185 kom	240 kom	290 kom	370 kom	570 kom	580 kom	740 kom
Aku potezna preklopna pila	TE-SM 36/210 Li		185 kom 350 kom	230 kom 435 kom	275 kom 525 kom	370 kom 700 kom	480 kom 910 kom	555 kom 1050 kom	740 kom 1400 kom
Akumulatorska preklopna pila	TE-MS 18/210 Li		103 kom	120 kom	154 kom	190 kom	250 kom	304 kom	380 kom
Akumulatorska stolna kružna pila	TE-TS 36/210 Li		60 m	71 m	92 m	122 m	160 m	184 m	244 m
Akumulatorske tračne pile za metal	TE-MB 18/127 U Li		30 kom	35 kom	45 kom	60 kom	78 kom	90 kom	120 kom
	TE-MB 18/127 Li		30 kom	35 kom	45 kom	60 kom	78 kom	90 kom	120 kom
Akumulatorski višenamjenski alati	VARRITO		30 min 720 kom	38 min 900 kom	45 min 1080 kom	60 min 1440 kom	78 min 1880 kom	90 min 2160 kom	120 min 2880 kom
	TC-MG 18 Li		30 min 720 kom	38 min 900 kom	45 min 1080 kom	60 min 1440 kom	78 min 1880 kom	90 min 2160 kom	120 min 2880 kom

VODIČ ZA BATERIJE - VRIJEME RADA S BATERIJOM



			18 V 2,0 Ah	18 V 2,5 Ah	18 V 3,0 Ah	18 V 4,0 Ah	18 V 5,2 Ah	18 V 6,0 Ah	18 V 8,0 Ah
Akumulatorska brusilica za zidove	TP-DW 18/225 Li		26 min	33 min	44 min	55 min	68 min	78 min	110 min
Akumulatorska tračna brusilica	TP-BS 18/457 Li Brushless		15 min	18 min	22 min	30 min	38 min	44 min	59 min
Akumulatorske vibracione brusilice	TE-OS 18/230 Li		27 min	33 min	40 min	54 min	70 min	80 min	108 min
	TC-OS 18/187 Li		34 min	42 min	50 min	67 min	87 min	100 min	134 min
Akumulatorska višenamjenska brusilica	TE-OS 18/150 Li		27 min	34 min	40 min	55 min	70 min	80 min	110 min
Akumulatorska ekscentrična brusilica	TE-RS 18 Li		20 min	25 min	30 min	40 min	52 min	60 min	80 min
Akumulatorska kutna polirka	CE-CP 18/180 Li E		20 min	25 min	35 min	43 min	54 min	65 min	86 min
Akumulatorska polirka	CE-CB 18/254 Li		81 min	93 min	112 min	127 min	200 min	222 min	254 min
Akumulatorske klamerice	FIXETTO 18/50 N		685 kom	857 kom	1028 kom	1370 kom	1782 kom	2055 kom	2740 kom
	TE-CN 18 Li		2030 kom 1995 kom	2670 kom 2642 kom	3204 kom 3171 kom	4272 kom 4228 kom	5554 kom 5496 kom	6408 kom 6342 kom	8544 kom 8456 kom
Akumulatorski pištolj za silikon	TE-SG 18/10 Li		171 kom	213 kom	256 kom	341 kom	443 kom	511 kom	682 kom
Aku pištolj za prskanje boje	TC-SY 18/60 Li		30 m ²	38 m ²	45 m ²	60 m ²	78 m ²	90 m ²	120 m ²
Aku radio	TC-RA 18 Li BT		16 h	20,5 h	24,5 h	32,5 h	42,5 h	49 h	65 h
Aku zvučnik	TC-SR 18 Li BT		57 h	72 h	86 h	114 h	148 h	171 h	228 h
Akumulatorske svjetiljke	TE-CL 18/2500 LiAC		85 min	107 min	137 min	183 min	238 min	274 min	366 min
	TE-CL 18/2000 LiAC		115 min	145 min	174 min	230 min	300 min	345 min	460 min
	TC-CL 18/1800 Li		118 min	140 min	191 min	243 min	300 min	350 min	486 min
	TC-CL 18 Li H		10 h	12 h	16 h	22 h	32 h	33 h	44 h
USB adapter za PXC bateriju	TC-CP 18 Li USB		12 h	13,5 h	16 h	24 h	32 h	36 h	48 h
Akumulatorski puhač	TE-CB 18/180 Li		39 min	48 min	62 min	68 min	100 min	124 min	136 min
Akumulatorski ventilator	GE-CF 18/2200 Li	min. maks.	5,3 h 2 h	7 h 2,6 h	8,8 h 3,3 h	10,6 h 4 h	14 h 5,3 h	21,2 h 8 h	28 h 10,6 h
Aku pištolj za vruće ljepljenje	TE-CG 18 Li		18 kom	22 kom	28 kom	36 kom	44 kom	50 kom	72 kom
Akumulatorski fen za vrući zrak	TE-HA 18 Li		9 min	11 min	13 min	17 min	22 min	26 min	34 min
Akumulatorski usisavači suho/mokro	TP-VC 36/30 S Auto	BOOST ECO	8 min 11 min	10 min 13 min	12 min 16 min	16 min 22 min	21 min 28 min	24 min 33 min	32 min 44 min
	TE-VC 36/30 Li S		8 min 11 min	10 min 13 min	12 min 16 min	16 min 22 min	21 min 28 min	24 min 33 min	32 min 44 min
	TE-VC 36/25 Li S		8 min 11 min	10 min 13 min	12 min 16 min	16 min 22 min	21 min 28 min	24 min 33 min	32 min 44 min

VODIČ ZA BATERIJE – VRIJEME RADA S BATERIJOM

									
			18 V 2,0 Ah	18 V 2,5 Ah	18 V 3,0 Ah	18 V 4,0 Ah	18 V 5,2 Ah	18 V 6,0 Ah	18 V 8,0 Ah
Akumulatorski usisavači suho/mokro	TC-VC 18/20 Li S		10 min	11 min	16 min	20 min	25 min	32 min	40 min
	TC-VC 18/15 Li		10 min	11 min	16 min	20 min	25 min	32 min	40 min
	TE-VC 18/10 Li		10 min	12 min	17 min	21 min	26 min	30 min	42 min
Akumulatorski ručni usisavači	TE-HV 18/06 Li	 BOOST ECO	12 min 22 min	15 min 26 min	19 min 33 min	25 min 44 min	32 min 54 min	39 min 65 min	50 min 88 min
	TE-VC 18 Li		16 min	18 min	23 min	31 min	40 min	46 min	62 min
Akumulatorski štapni usisavač	TE-SV 18 Li	 BOOST ECO	11 min 25 min	13 min 31 min	18 min 38 min	22 min 50 min	28 min 65 min	35 min 80 min	44 min 100 min
Akumulatorski usisavač pepela	TE-AV 18/15 Li C		15 min	18 min	22 min	30 min	37 min	44 min	60 min
Akumulatorski čistač prozora	BRILLIANTO		160 min	200 min	240 min	320 min	415 min	480 min	640 min
Akumulatorski stroj za metenje	TE-SW 18/610 Li	 3 km/h	850 m ² 27 min	1050 m ² 34 min	1300 m ² 41 min	1700 m ² 55 min	2200 m ² 72 min	2550 m ² 83 min	3400 m ² 110 min
Akumulatorski čistač odvoda	TE-DA 18/760 Li		56 min	68 min	94 min	112 min	143 min	188 min	232 min
Akumulatorski visokotlačni pištolj	HYPRESSO	 BOOST ECO	7 min 13 min	8 min 15 min	11 min 20 min	15 min 27 min	18 min 35 min	23 min 45 min	30 min 55 min
6u1 akumulatorski hibridni kompresori	PRESSITO 18/25 Hybrid		22 min	28 min	34 min	44 min	58 min	68 min	88 min
	PRESSITO		30 min	37 min	45 min	60 min	85 min	90 min	120 min
3u1 akumulatorski kompresori	PRESSITO 18/25		22 min	28 min	34 min	44 min	58 min	68 min	88 min
	PRESSITO 18/21		30 min	37 min	45 min	60 min	85 min	90 min	120 min
Akumulatorski kompresori	TE-AC 36/6/8 Li OF	 	25 kom 400 kom	29 kom 435 kom	40 kom 660 kom	50 kom 800 kom	60 kom 900 kom	80 kom 1320 kom	100 kom 1600 kom
	TE-AC 36/8 Li OF	 	8 min 6 min	10 min 7,5 min	12 min 9 min	16 min 12 min	21 min 15 min	24 min 18 min	32 min 24 min
Akumulatorski auto kompresor	CE-CC 18 Li		42 min	53 min	63 min	84 min	109 min	126 min	168 min
Akumulatorska zračna pumpa	CE-AP 18 Li		65 min	81 min	98 min	130 min	169 min	195 min	260 min
Akumulatorski stroj za rezanje pločica	TE-TC 18/115 Li		50 kom	63 kom	75 kom	100 kom	130 kom	150 kom	200 kom































79 rupa

OSNOVNA IZVEDBA – Preporučuje se nadogradnja









Vrijednosti u svjetlijim poljima (npr. vidi gore) pokazuju da se preporučuje korištenje baterije veće snage/kapaciteta za punu snagu i razumno vrijeme rada uređaja.

Sve navedene vrijednosti su maksimalne vrijednosti i određene su pod standardiziranim uvjetima ispitivanja. Ostvarive vrijednosti u svakodnevnoj uporabi mogu odstupati od toga.

Objašnjenje simbola:

-  Uvrtanje 6 x 60 mm vijaka u meko drvo – maks. količina po jednom punjenju baterije
-  Pritezanje / otpuštanje vijaka kotača (šesterokutna glava, veličina 22 mm) – maks. količina po jednom punjenju baterije
-  Uvrtanje vijaka 3,9 x 25 mm u knauf ploče
-  Bušenje \varnothing 6 mm / 50 mm u opeci – maks. broj po punjenju baterije
-  Bušenje \varnothing 6 mm / 50 mm u beton – maks. broj po punjenju baterije
-  **Boja**
 **Žbuka** Vrijeme miješanja zidne boje/žbuke po punjenju baterije
-  Rezanje okruglog čelika \varnothing 12 mm – maks. broj po punjenju baterije
-  Glodanje utora za ravne tiple (veličina 10) u mekom drvu – maks. broj po punjenju baterije
-  Blanjanje mekog drva (dubina: 1 mm, širina 50 mm) – maks. kapacitet blanjanja (u m) po punjenju baterije
-  Iverica 19 mm – maks. kapacitet rezanja (u m) po punjenju baterije
-  Okruglo drvo \varnothing 35 mm – maks. broj rezova po punjenju baterije
-  Greda od mekog drva 60 x 60 mm - maks. broj poprečnih presjeka po punjenju baterije
-  Četvrtasta cijev 40 x 40 x 2 mm - maks. broj poprečnih presjeka po punjenju baterije
-  Laminat 195 x 8 mm - maks. broj rezova po punjenju baterije
-  Maks. vrijeme rada u praznom hodu po punjenju baterije
-  Rezanje okrugle plastike \varnothing 10 mm - maks. broj po punjenju baterije
-  Patrone vrućeg ljepila \varnothing 11 mm, duljina 200 mm – maks. broj iskorištenih patrona vrućeg ljepila po punjenju baterije
-  32 mm čavli u mekom drvu pri podešenoj maksimalnoj dubini – maks. broj po punjenju baterije
-  22 mm spajalice u mekom drvu pri podešenoj maksimalnoj dubini – maks. broj po punjenju baterije
-  Maks. broj patrona po punjenju baterije
-  Maks. radno područje po punjenju baterije s viskoznošću 60 DIN-sek uz jednostavno nanošenje boje
-  Vrijeme trajanja po punjenju baterije
-  Maks. vrijeme rada po punjenju baterije
-  **min.**
maks. Maks. vrijeme rada pri min. broju okretaja
Maks. vrijeme rada pri maks. broju okretaja
-  **BOOST**
ECO Maks. vrijeme rada u mirovanju po punjenju baterije u BOOST / ECO načinu rada
-  3 km/h Maks. radno područje po punjenju baterije brzinom hoda od 3 km/h
-  13 mm spajalice u mekom drvu - maks. broj po punjenju baterije
-  Maks. vrijeme rada pri korištenju pištolja za puhanje
-  Maks. vrijeme rada pri pumpanju automobilske gume na 2,5 bara
-  Keramičke pločice 15 x 15 cm – maks. performanse rezanja po punjenju baterije
-  Glodanje utora u mekom drvu (dubina: 3 mm, \varnothing rezača: 6 mm) – maks. kapacitet rezanja (u m) po punjenju baterije
-  Maks. broj ciklusa punjenja spremnika kompresora po punjenju baterije

TABLICA VREMENA PUNJENJA BATERIJA

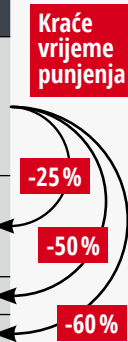
									
	1,5 Ah	2,0 Ah	2,5 Ah	3,0 Ah	4,0 Ah	5,2 Ah	6,0 Ah	8,0 Ah	
Power X-Charger 3 A									
Power X-Twincharger 3 A (Istovremeno punjenje 2 baterije)	30 min	40 min	50 min	60 min	75 min	100 min	120 min	160 min	
Power X-Car Charger 3 A									
Power X-Fastcharger 4 A									
2x2 Power X-Quattrocharger 4 A (Istovremeno punjenje 2 baterije)	24 min	30 min	37 min	45 min	60 min	80 min	90 min	120 min	
Power X-Boostcharger 6 A *	24 min	30 min	27 min	32 min	40 min	50 min	60 min	80 min	
Power X-Boostcharger 8 A **	24 min	30 min	27 min	32 min	40 min	40 min	45 min	60 min	

* Samo baterije od 2,5 Ah - 8,0 Ah mogu se puniti sa 6 A. Baterije manjeg kapaciteta pune se nižom strujom.

** Samo baterije od 5,2 Ah - 8,0 Ah mogu se puniti s 8 A. Baterije manjeg kapaciteta pune se nižom strujom.

POWER X-CHANGE PARTNERI. SNAŽNA SURADNJA SA SNAŽNIM PROIZVODIMA

“Sloboda bez kabela za sve.” To je vizija brenda Einhell. Mnogi već znaju da akumulatorski odvijajući, akumulatorske ručne kružne pile, akumulatorske kosilice i slično mogu raditi s jednom te istom baterijom u sklopu Power X-Change akumulatorskog sistema. Kako bismo našim kupcima uz radionicu i vrt mogli ponuditi mnoge druge Power X-Change aplikacije, otvorili smo našu baterijsku platformu za partnere iz drugih područja. Naši partneri već koriste naše Power X-Change baterije u svojim proizvodima - a broj i dalje raste!

ZABAVNA MISIJA KROZ SNAGU BATERIJE

Ride-On Audi R8 Spyder, Jamara

- Dimenzije (d x š x v): 106 x 62 x 34 cm
- Maksimalna brzina: cca 5 km/h
- Maksimalna težina: 25 kg

Artikl dostupan isključivo bez baterije / punjača Broj artikla: 60.000.13

Ostale boje dostupne su na www.Jamara-shop.com.

- Pogon na 2 kotača s 2 snažna pogonska motora
- Bluetooth i USB veza za glazbu
- Stražnji ovjes
- Sportski volan i LED prednja svjetla



E-MOBILNOST UZ POWER X-CHANGE

E-Kickscooter ELMOTO KICK, GOVECS

- Legalno za cestu: da
- Napon baterije: 2x 18 = 36 V
- Maksimalna brzina: 20 km/h
- Domet: do 15 km
- Težina: 15 kg (s baterijom)

Artikl dostupan isključivo bez baterije / punjača Broj artikla: 48.500.61



- Posebno stabilan okvir i velike 10-inčne pneumatske gume s 2 disk kočnice za najbolju udobnost vožnje i maksimalnu sigurnost
- LCD zaslon – brzina, status baterije, domet
- Sklopivi upravljač s funkcijom hvatanja i nošenja

ELMOTO KICK je također dostupan u dvije dodatne boje na www.govecs.de:



KAMPIRANJE S E.POWER TEHNOLOGIJOM

Knaus/Weinsberg – Punjač za kampere

U odabranim modelima kampera iz Knausa i Weinsberga, hladnjak, vodena pumpa i svjetlo mogu raditi do 10 sati s našim Power X-Change baterijama. Na taj način kupac svoju kamp prikolicu može samostalno opskrbiti energijom tijekom noći. Naravno, baterija se može ukloniti u bilo kojem trenutku i jednostavno umetnuti u neki od ostalih 250+ aku alata, poput aku usisavača ili aku kompresora. Naša Power X-Change baterija savršen je suputnik za vaše sljedeće kampiranje.



Saznajte više na www.knaus.com

NEOGRANIČENO ISKUSTVO USISAVANJA ZAHVALJUJUĆI SUSTAVU ZAMJENE BATERIJA

Aku štapni usisavač SEPURO, Severin

Severin se oslanja na Power X-Change akumulatorsku platformu za inovativni SEPURO ručni i štapni usisavač. S baterijom od 3,0 Ah uključenom u isporuku, SEPURO PRO postiže vrijeme rada do 60 minuta, odnosno neprekidno usisavanje zahvaljujući svom sustavu izmjenjivih baterija! Usisavač jamči beskompromisnu čistoću. Po izboru kao model sa ili bez vrećice, postavlja nove standarde u pogledu higijene i siguran je za alergičare.

Saznajte više na www.severin.com



POWER X-CHANGE VRT



POWER X-CHANGE ROBOTSKE KOSILICE

POWER X-CHANGE LITIJ-IONSKA BATERIJA

Baterija se može koristiti u svim uređajima iz Power X-Change obitelji

INTEGRIRANA KAMERA

Prepoznaje područje košnje i vizualne granice travnjaka, npr. kamenje, asfalt ili malč

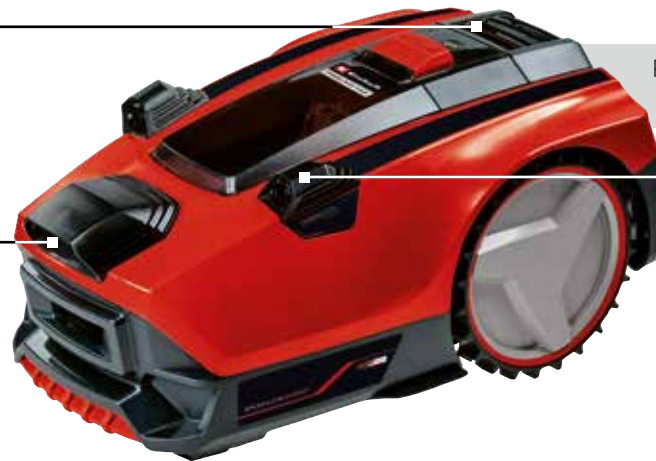

Power X-Change robotska kosilica **FREELEXO CAM 500**

ULTRAZVUČNI SENZORI

Senzori detektiraju prepreke i fizičke granice travnjaka kao što su živice, zidovi ili drveće



POWER X-CHANGE ROBOTSKA KOSILICA



PRAVA SLOBODA BEZ KABELA

Nije potrebna granična žica



INTUITIVNA TIPKOVNICA

Jednostavan rad s programiranjem vremena košnje za dnevnu ili dvodnevnu njegu travnjaka



ODVOJENE VRTNE POVRŠINE

Način košnje za površine travnjaka odvojene od glavnog vrta



SENZOR ZA KIŠU

Za rad prilagođen travnjaku

	FREELEXO CAM 500 EXPERT NOVO
PXC baterija napon / kapacitet	18 V / 3,0 Ah
Preporučeno za travnjake do cca.*	500 m ²
Širina košnje	18 cm
Podešavanje visine košnje	Beskonačno / 20 - 60 mm / centralno
Pogodno za nagibe do maks.	25%
PXC baterija	•
Aplikacija	-
Intuitivna tipkovnica	•
Košnja bez granične žice	•
Integrirana kamera i senzori za prepreke	•
Magnetna traka za virtualne granice	• (5 m, uključeno u isporuku)
Programiranje radnog vremena	•
Program košnje za rubna područja	•
Eko način rada	•
Senzori za udarce, podizanje i nagib	•
Motor bez četkica	•
Uključena stanica za punjenje	• (uključen kabel za navođenje od 12 m)
Broj baterija / punjača	1 / 0
Uključena granična žica	Nije potrebno
Broj artikla	34.139.91

* Navedena pokrivenost područja temelji se na pretpostavci idealnih uvjeta



FREELEXO CAM

AKUMULATORSKA ROBOTSKA KOSILICA BEZ GRANIČNE ŽICE - PREPOZNAJE PREPREKE I GRANICE



FIZIČKE GRANICE

Npr. ograde, živice, drveće



VIZUALNE GRANICE

Npr. malč od kore, asfalt, kamenje

VIRTUALNA OGRADA TO OMOGUĆUJE - ZAHVALJUJUĆI PRIBORU MAGNETSKE TRAKE

Postavljena u vrtu, priložena magnetska traka djeluje kao virtualna ograda. Ugrađeni magnetski senzori u FREELEXO CAM prepoznaju magnetsku traku i okreću se od krajnjih granica. Na ovaj način možete u kratkom roku kreirati zabranjena područja.



PRIVREMENO RAZGRANIČENJE

Bliži se vrtna zabava i robotska kosilica privremeno ne bi trebala prilaziti prostoru za sjedenje

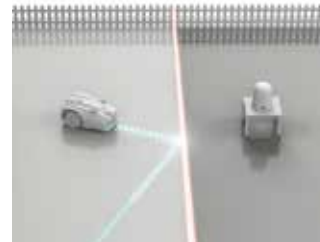

CVJETNJAK U VRTU

Cvjetnjak u vrtu tek počinje rasti i već privlači insekte, ali ne želite da robotska kosilica prelazi preko



NOVOPOSADENO STABLO



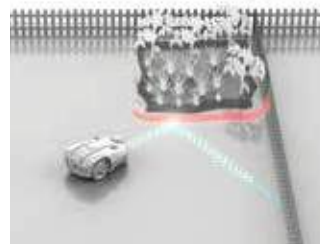

Novoposađeno stablo još je uvijek osjetljivo i u početku je virtualnom ogradom zaštićeno od sudara s robotskom kosilicom



USKLAĐIVANJE RUBOVA TRAVNJAKA

Rubovi travnjaka koji su robotskoj kosilici teško vidljivi mogu se razgraničiti magnetskom trakom kako bi se optimalno razgraničilo područje košnje u vrtu

PRIBOR ZA FREELEXO CAM

		Broj artikla	EAN	Opseg isporuke	Pogodan za
	Garaža za Freelexo robotsku kosilicu	34.140.24	4 006825 654417	1 kom (sklopiva, DxŠxV: 77x59x39,5 cm)	Sve Einhell robotske kosilice
	Rezervni nožići za robotsku kosilicu, 12/1	34.140.20	4 006825 648775	12 kom	
	Set za čišćenje za robotsku kosilicu	34.140.25	4 006825 657951	Rukavice, četke, brusne ploče, krpa od mikrovlakana, lopatica, odvijač	
	Set magnetske trake za Freelexo CAM	34.140.28	4 006825 670929	Magnetska traka (duljina: 20 m), 20 kuka za pričvršćivanje	FREELEXO CAM

POWER X-CHANGE ROBOTSKE KOSILICE



	FREELEXO 300 LCD BT+ Solo EXPERT NOVO	FREELEXO 500 LCD BT+ EXPERT	FREELEXO 600 BT EXPERT
PXC baterija napon / kapacitet	18 V / -	18 V / 2,5 Ah	18 V / 2,5 Ah
Preporučeno za travnjake do cca.*	300 m ²	500 m ²	600 m ²
Širina košnje	18 cm	18 cm	18 cm
Podešavanje visine košnje	Beskonačno / 20 - 60 mm / centralno	Beskonačno / 20 - 60 mm / centralno	Beskonačno / 20 - 60 mm / centralno
Pogodno za nagibe do maks.	35 %	35 %	35 %
PXC baterija	•	•	•
Aplikacija	Bluetooth	Bluetooth	Bluetooth
LCD zaslon	•	•	-
Podešavanje dnevnog radnog vremena	•	•	•
Izračun vremena košnje na temelju trenutnih vremenskih podataka	-	-	-
Funkcija košnje više područja	•	•	•
Funkcija košnje određenog mjesta	•	•	-
Program košnje za rubna područja	•	•	-
Eko način rada	•	•	-
Senzori za udarce, podizanje i nagib	•	•	•
Motor bez četkica	•	•	•
Uključena stanica za punjenje	•	•	•
Broj baterija / punjača	0 / 0	1 / 0	1 / 0
Uključena granična žica	100 m	130 m	140 m
Uključene kuke za pričvršćivanje	140 kom	190 kom	200 kom
Uključeni pribor	4 spojnice, 3 zamjenske oštrice	4 spojnice, 3 zamjenske oštrice	4 spojnice, 3 zamjenske oštrice
Broj artikla	34.139.84	34.139.82	34.139.46

* Navedena pokrivenost područja temelji se na pretpostavci idealnih uvjeta



UKLJUČENA STANICA ZA PUNJENJE

Uključena stanica za punjenje uključena je u isporuku svake robotske kosilice, bilo u kompletu ili solo!



Slika može odstupati od originala



POTVRĐENA KVALITETA

Razni testni instituti i časopisi potvrđuju visoku kvalitetu naše Power X-Change robotske kosilice s vrlo dobrim rezultatima ispitivanja.



POWER X-CHANGE ROBOTSKE KOSILICE



Power X-Change robotska kosilica
FREELEXO SMART 750

SMART TECHNOLOGY



POWER X-CHANGE ROBOTSKA KOSILICA



PAMETNI NAČIN RADA

U pametnom načinu rada, robotska kosilica samostalno stvara raspored optimalno prilagođen vremenskim prilikama, veličini vrta i preferencijama kupaca



MOŽE SE POVEZATI S EINHELL PAMETNIM UREĐAJIMA

Einhell pametni uređaji automatski koordiniraju jedni s drugima u pametnom načinu rada



PRISTUP IZ DALJINE

Uz pametni telefon, njega travnjaka sada je moguća s bilo kojeg mjesta, zahvaljujući mobilnoj internetskoj vezi uređaja



NIJE POTREBAN WI-FI ili BLUETOOTH

Neograničen domet zahvaljujući komunikaciji putem mobilne mreže



PREPOZNAVANJE VREMENSKIH PRILIKA

U pametnom načinu rada robotska kosilica prilagođava se lokalnim vremenskim uvjetima zahvaljujući vremenskim prognozama kako bi postigla najbolji mogući rezultat

Još jedan SMART uređaj iz Einhell asortimana:
**Automatska vrtna pumpa
GE-AW 1144 SMART** (vidi str. 126)



FREELEXO SMART 750	
PROFESSIONAL NOVO	
PXC baterija napon / kapacitet	18 V / 3,0 Ah
Preporučeno za travnjake do cca.*	750 m ²
Širina košnje	18 cm
Podешavanje visine košnje	Beskonačno / 20 - 60 mm / centralno
Pogodno za nagibe do maks.	35 %
PXC baterija	•
Aplikacija	GSM / Smart
LCD zaslon	•
Podешavanje dnevnog radnog vremena	•
Izračun vremena košnje na temelju trenutnih vremenskih podataka	•
Funkcija košnje više područja	•
Funkcija košnje određenog mjesta	•
Program košnje za rubna područja	•
Eko način rada	•
Mogućnost spajanja s Einhell SMART uređajima	•
Senzori za udarce, podizanje i nagib	•
Motor bez četkica	•
Uključena stanica za punjenje	•
Broj baterija / punjača	1 / 0
Uključena granična žica	175 m
Uključene kuke za pričvršćivanje	245 kom
Uključeni pribor	4 spojnice, 3 zamjenske oštrice
Broj artikla	34.138.11



* Navedena pokrivenost područja temelji se na pretpostavci idealnih uvjeta

POWER X-CHANGE ROBOTSKE KOSILICE



	FREELEXO 900 LCD BT EXPERT	FREELEXO 1200 LCD BT EXPERT
PXC baterija napon / kapacitet	18 V / 3,0 Ah	18 V / 5,2 Ah
Preporučeno za travnjake do cca.*	900 m ²	1200 m ²
Širina košnje	18 cm	18 cm
Podešavanje visine košnje	Beskonačno / 20 - 60 mm / centralno	Beskonačno / 20 - 60 mm / centralno
Pogodno za nagibe do maks.	35 %	35 %
PXC baterija	•	•
Aplikacija	Bluetooth	Bluetooth
LCD zaslon	•	•
Podešavanje dnevnog radnog vremena	•	•
Izračun vremena košnje na temelju trenutnih vremenskih podataka	-	-
Funkcija košnje više područja	•	•
Funkcija košnje određenog mjesta	-	-
Program košnje za rubna područja	-	-
Eko način rada	-	-
Senzori za udarce, podizanje i nagib	•	•
Motor bez četkica	•	•
Uključena stanica za punjenje	•	•
Broj baterija / punjača	1 / 0	1 / 0
Uključena granična žica	190 m	210 m
Uključene kuke za pričvršćivanje	270 kom	300 kom
Uključeni pribor	4 spojnice, 3 zamjenske oštrice	4 spojnice, 3 zamjenske oštrice
Broj artikla	34.139.55	43.263.68

* Navedena pokrivenost područja temelji se na pretpostavci idealnih uvjeta



PRIBOR ZA ROBOTSKE KOSILICE S GRANIČNOM ŽICOM

	Broj artikla	EAN	Opseg isporuke	Pogodan za
Garaža za Freelexo robotsku kosilicu	34.140.24	4 006825 654417	1 kom (sklopiva, DxŠxV: 77x59x39,5 cm)	Sve Einhell robotske kosilice
Granična žica za robotsku kosilicu, 50 m	34.140.21	4 006825 648782	1 kom (50 m)	
Rezervni nožići za robotsku kosilicu, 12/1	34.140.20	4 006825 648775	12 kom	
Klin za pričvršćivanje granične žice za robotsku kosilicu, 100/1	34.140.23	4 006825 648805	100 kom	
Spojne stezaljke za robotsku kosilicu, 4/1	34.140.22	4 006825 648799	4 kom	
Set za popravak za robotsku kosilicu	34.140.26	4 006825 657968	5 m granične žice, 15 kom kuke za pričvršćivanje, 8 kom spojnice	
Set za čišćenje za robotsku kosilicu	34.140.25	4 006825 657951	Rukavice, četke, brusne ploče, krpa od mikrovlakana, lopatica, odvlač	

BENZINSKE KOSILICE (S PXC E-STARTOM)



	GC-PM 51/3 S HW-E Li CLASSIC	GC-PM 46 SM HW-E Li CLASSIC
Motor / obujam	4-taktni / 170 cm ³	4-taktni / 146 cm ³
Snaga / radna brzina	2,7 kW / 2900 min ⁻¹	2,0 kW / 2900 min ⁻¹
PXC baterija napon / kapacitet	1x 18 V / 2,0 Ah	1x 18 V / 2,0 Ah
Vrijeme punjenja	2,5 h	2,5 h
Širina košnje	51 cm	46 cm
Podšavanje visine košnje	6 postavki / 30 - 80 mm / centralno	9 postavki / 25 - 80 mm / centralno
Kapacitet košare za travu	70 l	65 l
Promjer kotača prednji / stražnji	204 mm / 280 mm	204 mm / 280 mm
Materijal kućišta	Plastificirani čelični lim	Plastificirani čelični lim
Preporučeno za travnjake do cca.*	1800 m ²	1400 m ²
Težina proizvoda	34,8 kg	32,1 kg
Visoki kotači	•	•
Samohodna	•	•
Elektro start s Power X-Change baterijom (18 V)	•	•
Funkcija malčiranja	•	•
Sklopiva ručka podesiva po visini s mekim rukohvatom	•	•
Košara za travu s indikatorom napunjenosti	•	•
Češalj za travu	-	•
Broj baterija / punjača	1 / 1	1 / 1
Broj artikla	34.048.70	34.075.60

* Navedena pokrivenost područja temelji se na pretpostavci idealnih uvjeta



POWER X-CHANGE ELEKTRO START

Praktično pokretanje benzinskog motora s funkcijom električnog paljenja pomoću Power X-Change aku sistema – dovoljan je samo jedan pritisak na gumb:

- Bez dosadnog ručnog pokretanja užetom
- Baterija se također može koristiti za ostale Power X-Change uređaje



AKUMULATORSKE KOSILICE

RASARRO

ALUMINIJSKA RUČKA
Posebno stabilna i lagana

INTEGRIRANA RUČKA ZA NOŠENJE
Jednostavan transport

CENTRALNO PODEŠAVANJE VISINE KOŠNJE
Praktično i jednostavno podešavanje visine košnje u 6 postavki

Akumulatorska kosilica
RASARRO 36/42

ČEŠALJ ZA TRAVNJAK
Bočni češljevi za travnjak optimiziraju košnju blizu ruba

ERGONOMSKA RUČKA S MEKIM RUKOHVATOM
Omogućuje rad bez umora

TELESKOPSKA RUČKA
Individualna teleskopska ručka, tj. podesiva po visini, omogućuje jednostavno prilagođavanje visini korisnika

SKLOPIVA RUČKA
Sklopivi mehanizam osigurava praktičnu pohranu nakon upotrebe koja štedi prostor

KOŠARA ZA TRAVU 50 L S INDIKATOROM RAZINE
Optimalno prikupljanje i punjenje košare

VIŠE SNAGE I DULJE VRIJEME RADA
Osim ostalih prednosti, motor bez četkica jamči maksimalnu snagu s dužim trajanjem po jednom punjenju baterije

AKUMULATORSKA KOSILICA

RASARRO

**36 V
POWER
2 x 18 V**

**PUREPOWER
BRUSHLESS**



**PUREPOWER
BRUSHLESS**

RASARRO

RASARRO karakteriziraju sljedeće glavne karakteristike:

- 1. Aluminijska ručka**
Aluminijska ručka izuzetno je stabilna i lagana u isto vrijeme. To jamči ciljano upravljanje, dugi radni vijek i također savršeno jednostavno rukovanje
- 2. Ergonomski oblikovana ručka**
Posebno ergonomski oblikovana ručka s mekim rukohvatom učinkovito sprječava znakove umora tijekom dužeg radnog vremena

	RASARRO 36/42 PROFESSIONAL	NOVO
PXC baterija napon / kapacitet	2x 18 V / 5,2 Ah	
Vrijeme punjenja	100 min	
Preporučeno za travnjake do cca.*	725 m ²	
Širina košnje	42 cm	
Podešavanje visine košnje	6 postavki / 25 - 75 mm / centralno	
Kapacitet košare za travu	50 l	
Promjer kotača prednji / stražnji	150 mm / 220 mm	
Materijal kućišta	Plastika	
Težina proizvoda	17,2 kg	
Funkcija malčiranja	•	
Integrirana ručka za nošenje	•	
Motor bez četkica	•	
Ručka podesiva po visini	• (teleskopska)	
Sklopiva ručka	•	
Košara za travu s indikatorom napunjenosti	•	
Veliki kotači pogodni za travnjak	•	
Broj baterija / punjača	2 / 1 (Twincharger - dupli punjač)	
Broj artikla	34.132.72	

* Navedena pokrivenost područja temelji se na pretpostavci idealnih uvjeta



AKUMULATORSKE
KOSILICE**36 V**
POWER
2 x 18 V**PUREPOWER**
BRUSHLESS

RASARRO



	RASARRO 36/40 PROFESSIONAL NOVO	RASARRO 36/38 PROFESSIONAL NOVO
PXC baterija napon / kapacitet	2x 18 V / 4,0 Ah	2x 18 V / 4,0 Ah
Vrijeme punjenja	75 min	75 min
Preporučeno za travnjake do cca.*	500 m ²	450 m ²
Širina košnje	40 cm	38 cm
Podešavanje visine košnje	6 postavki / 25 - 75 mm / centralno	6 postavki / 25 - 75 mm / centralno
Kapacitet košare za travu	50 l	45 l
Promjer kotača prednji / stražnji	150 mm / 220 mm	150 mm / 220 mm
Materijal kućišta	Plastika	Plastika
Težina proizvoda	17,4 kg	15,5 kg
Funkcija malčiranja	-	•
Integrirana ručka za nošenje	•	•
Motor bez četkica	•	•
Ručka podesiva po visini	•	• (teleskopska)
Sklopiva ručka	•	•
Košara za travu s indikatorom napunjenosti	•	•
Veliki kotači pogodni za travnjak	•	•
Broj baterija / punjača	2 / 1 (Twincharger - dupli punjač)	2 / 1 (Twincharger - dupli punjač)
Broj artikla	34.132.78	34.131.80

* Navedena pokrivenost područja temelji se na pretpostavki idealnih uvjeta



4 006825 669121



4 006825 635867

AKUMULATORSKE
KOSILICE**36 V**
POWER
2 x 18 V

RASARRO



	RASARRO 36/36 EXPERT NOVO	RASARRO 36/34 EXPERT NOVO
PXC baterija napon / kapacitet	2x 18 V / 3,0 Ah	2x 18 V / 3,0 Ah
Vrijeme punjenja	60 min	60 min
Preporučeno za travnjake do cca.*	400 m ²	300 m ²
Širina košnje	36 cm	34 cm
Podešavanje visine košnje	6 postavki / 25 - 75 mm / centralno	5 postavki / 25 - 65 mm / centralno
Kapacitet košare za travu	45 l	30 l
Promjer kotača prednji / stražnji	150 mm / 220 mm	150 mm / 180 mm
Materijal kućišta	Plastika	Plastika
Težina proizvoda	13,0 kg	13,9 kg
Funkcija malčiranja	-	-
Integrirana ručka za nošenje	•	•
Motor bez četkica	-	-
Ručka podesiva po visini	•	•
Sklopiva ručka	•	•
Košara za travu s indikatorom napunjenosti	•	•
Veliki kotači pogodni za travnjak	•	•
Broj baterija / punjača	2 / 2	2 / 2
Broj artikla	34.132.82	34.132.22

* Navedena pokrivenost područja temelji se na pretpostavki idealnih uvjeta



4 006825 669114



4 006825 668605

AKUMULATORSKA KOSILICA

**36 V
POWER
2 x 18 V**

**DOUBLE
TWINPACK
TECHNOLOGY**

**PUREPOWER
BRUSHLESS**



GP-CM 36/47 S HW Li Brushless	
PROFESSIONAL	
PXC baterija napon / kapacitet	4x 18 V / 4,0 Ah
Vrijeme punjenja	75 min
Preporučeno za travnjake do cca.*	700 m ²
Širina košnje	47 cm
Podešavanje visine košnje	6 postavki / 30 - 65 mm / centralno
Kapacitet košare za travu	75 l
Promjer kotača prednji / stražnji	200 mm / 280 mm
Materijal kućišta	Čelični lim
Težina proizvoda	31,0 kg
Varijabilni samohodni pogon	•
Funkcija malčiranja	•
Integrirana ručka za nošenje	•
Motor bez četkica	•
Ručka podesiva po visini	•
Sklopiva ručka	•
Košara za travu s indikatorom napunjenosti	•
Veliki kotači pogodni za travnjak	•
Broj baterija / punjača	4 / 2 (Twincharger - dupli punjač)
Strugač za čišćenje	•
Broj artikla	34.132.00

* Navedena pokrivenost područja temelji se na pretpostavci idealnih uvjeta



AKUMULATORSKA KOSILICA

**36 V
POWER
2 x 18 V**

**DOUBLE
TWINPACK
TECHNOLOGY**

**PUREPOWER
BRUSHLESS**



GE-CM 36/48 Li M Brushless - Solo	
EXPERT	
PXC baterija napon / kapacitet	2x 18 V / -
Vrijeme punjenja	-
Preporučeno za travnjake do cca.*	-
Širina košnje	48 cm
Podešavanje visine košnje	6 postavki / 30 - 75 mm / osovinsko
Kapacitet košare za travu	-
Promjer kotača prednji / stražnji	180 mm / 180 mm
Materijal kućišta	Čelični lim
Težina proizvoda	16,9 kg
Funkcija malčiranja	•
Integrirana ručka za nošenje	-
Motor bez četkica	•
Ručka podesiva po visini	•
Sklopiva ručka	•
Košara za travu s indikatorom napunjenosti	-
Veliki kotači pogodni za travnjak	•
Broj baterija / punjača	0 / 0
Broj artikla	34.130.54

* Navedena pokrivenost područja temelji se na pretpostavci idealnih uvjeta



**DOUBLE
TWINPACK
TECHNOLOGY**

DOUBLE TWINPACK TEHNOLOGIJA

Double Twinpack uređaji nude utore za dvije dodatne baterije. Na primjer, ako u akumulatorsku kosilicu GP-CM 36/47 S HW Li stavite još dvije baterije tako da sva četiri utora za baterije budu zauzeta, možete pokositi dvostruko veću površinu bez punjenja.

Primjer (GP-CM 36/47 S HW Li):
Twinpack
2x 18 V = 350 m²
Double Twinpack
2x 18 V + 2x 18 V =
350 m² + 350 m² = 700 m²

AKUMULATORSKE
KOSILICE**36 V**
POWER
2 x 18 V**PUREPOWER**
BRUSHLESS

	GE-CM 36/43 Li M Brushless EXPERT	GE-CM 36/43 Li M Brushless - Solo EXPERT
PXC baterija napon / kapacitet	2x 18 V / 4,0 Ah	2x 18 V / -
Vrijeme punjenja	75 min	-
Preporučeno za travnjake do cca.*	600 m ²	-
Širina košnje	43 cm	43 cm
Podešavanje visine košnje	6 postavki / 25 - 75 mm / centralno	6 postavki / 25 - 75 mm / centralno
Kapacitet košare za travu	63 l	63 l
Promjer kotača prednji / stražnji	160 mm / 250 mm	160 mm / 250 mm
Materijal kućišta	Plastika	Plastika
Težina proizvoda	16,3 kg	13,2 kg
Funkcija malčiranja	•	•
Integrirana ručka za nošenje	•	•
Motor bez četkica	•	•
Ručka podesiva po visini	•	•
Sklopiva ručka	•	•
Košara za travu s indikatorom napunjenosti	•	•
Veliki kotači pogodni za travnjak	•	•
Broj baterija / punjača	2 / 2	0 / 0
Broj artikla	34.132.40	34.132.46

* Navedena pokrivenost područja temelji se na pretpostavci idealnih uvjeta



4 006825 645866



4 006825 648720

AKUMULATORSKE
KOSILICE**36 V**
POWER
2 x 18 V**PUREPOWER**
BRUSHLESS

	GP-CM 36/41 Li Brushless - Solo PROFESSIONAL	GE-CM 36/37 Li - Solo EXPERT
PXC baterija napon / kapacitet	2x 18 V / -	2x 18 V / -
Vrijeme punjenja	-	-
Preporučeno za travnjake do cca.*	-	-
Širina košnje	41 cm	37 cm
Podešavanje visine košnje	6 postavki / 25 - 75 mm / centralno	6 postavki / 25 - 75 mm / centralno
Kapacitet košare za travu	50 l	45 l
Promjer kotača prednji / stražnji	150 mm / 220 mm	150 mm / 220 mm
Materijal kućišta	Plastika	Plastika
Težina proizvoda	15,2 kg	13,5 kg
Funkcija malčiranja	-	-
Integrirana ručka za nošenje	•	•
Motor bez četkica	•	-
Ručka podesiva po visini	•	•
Sklopiva ručka	•	•
Košara za travu s indikatorom napunjenosti	•	•
Veliki kotači pogodni za travnjak	•	•
Broj baterija / punjača	0 / 0	0 / 0
Broj artikla	34.132.75	34.131.72

* Navedena pokrivenost područja temelji se na pretpostavci idealnih uvjeta



4 006825 652093



4 006825 635898

AKUMULATORSKE KOSILICE

**36 V
POWER
2 x 18 V**



	GE-CM 36/36 Li Brushless EXPERT	GE-CM 36/34-1 Li - Solo EXPERT
PXC baterija napon / kapacitet	2x 18 V / 4,0 Ah	2x 18 V / -
Vrijeme punjenja	75 min	-
Preporučeno za travnjake do cca.*	400 m ²	-
Širina košnje	36 cm	33.5 cm
Podešavanje visine košnje	6 postavki / 25 - 75 mm / centralno	5 postavki / 25 - 65 mm / centralno
Kapacitet košare za travu	40 l	30 l
Promjer kotača prednji / stražnji	145 mm / 220 mm	150 mm / 180 mm
Materijal kućišta	Plastika	Plastika
Težina proizvoda	13,4 kg	11,9 kg
Funkcija malčiranja	-	-
Integrirana ručka za nošenje	•	•
Motor bez četkica	•	-
Ručka podesiva po visini	•	•
Sklopiva ručka	•	•
Košara za travu s indikatorom napunjenosti	•	•
Veliki kotači pogodni za travnjak	•	•
Broj baterija / punjača	2 / 2	0 / 0
Broj artikla	34.132.30	34.132.26

* Navedena pokrivenost područja temelji se na pretpostavci idealnih uvjeta



4 006825 645835



4 006825 645026

**PONOVNO POBJEDNIK.
U STIFTUNG WARENTEST.**



AKUMULATORSKA KOSILICA

36 V
POWER
2 x 18 V



	GE-CM 36/33 Li EXPERT
PXC baterija napon / kapacitet	2x 18 V / 2,5 Ah
Vrijeme punjenja	50 min
Preporučeno za travnjake do cca.*	250 m ²
Širina košnje	33 cm
Podešavanje visine košnje	5 postavki / 25 - 65 mm / centralno
Kapacitet košare za travu	30 l
Promjer kotača prednji / stražnji	150 mm / 180 mm
Materijal kućišta	Plastika
Težina proizvoda	11,6 kg
Funkcija malčiranja	-
Integrirana ručka za nošenje	•
Motor bez četkica	-
Ručka podesiva po visini	•
Sklopiva ručka	•
Košara za travu s indikatorom napunjenosti	•
Veliki kotači pogodni za travnjak	•
Broj baterija / punjača	2 / 2
Broj artikla	34.132.10

* Navedena pokrivenost područja temelji se na pretpostavci idealnih uvjeta



4 006825 645002

AKUMULATORSKE KOSILICE



PUREPOWER
BRUSHLESS



	GE-CM 18/33 Li Brushless EXPERT	GE-CM 18/33 Li Brushless - Solo EXPERT
PXC baterija napon / kapacitet	18 V / 4,0 Ah	18 V / -
Vrijeme punjenja	75 min	-
Preporučeno za travnjake do cca.*	200 m ²	-
Širina košnje	33 cm	33 cm
Podešavanje visine košnje	5 postavki / 25 - 65 mm / centralno	5 postavki / 25 - 65 mm / centralno
Kapacitet košare za travu	30 l	30 l
Promjer kotača prednji / stražnji	150 mm / 180 mm	150 mm / 180 mm
Materijal kućišta	Plastika	Plastika
Težina proizvoda	10,9 kg	10,1 kg
Funkcija malčiranja	-	-
Integrirana ručka za nošenje	•	•
Motor bez četkica	•	•
Ručka podesiva po visini	•	•
Sklopiva ručka	•	•
Košara za travu s indikatorom napunjenosti	•	•
Veliki kotači pogodni za travnjak	•	•
Broj baterija / punjača	1 / 1	0 / 0
Broj artikla	34.132.60	34.132.66

* Navedena pokrivenost područja temelji se na pretpostavci idealnih uvjeta



4 006825 646856



4 006825 647686

AKUMULATORSKA KOSILICA



	GE-CM 18/32 Li Brushless - Solo EXPERT
PXC baterija napon / kapacitet	18 V / -
Vrijeme punjenja	-
Preporučeno za travnjake do cca.*	-
Širina košnje	32 cm
Podešavanje visine košnje	3 postavke / 30 - 70 mm / osovinsko
Kapacitet košare za travu	25 l
Promjer kotača prednji / stražnji	140 mm / 140 mm
Materijal kućišta	Plastika
Težina proizvoda	8,5 kg
Funkcija malčiranja	-
Integrirana ručka za nošenje	•
Motor bez četkica	•
Ručka podesiva po visini	-
Sklopiva ručka	•
Košara za travu s indikatorom napunjenosti	-
Veliki kotači pogodni za travnjak	•
Broj baterija / punjača	0 / 0
Broj artikla	34.132.56

* Navedena pokrivenost područja temelji se na pretpostavci idealnih uvjeta



AKUMULATORSKE KOSILICE



	GE-CM 18/30 Li Brushless EXPERT	GE-CM 18/30 Li Brushless - Solo EXPERT
PXC baterija napon / kapacitet	18 V / 3,0 Ah	18 V / -
Vrijeme punjenja	60 min	-
Preporučeno za travnjake do cca.*	150 m ²	-
Širina košnje	30 cm	30 cm
Podešavanje visine košnje	3 postavke / 30 - 70 mm / osovinsko	3 postavke / 30 - 70 mm / osovinsko
Kapacitet košare za travu	25 l	25 l
Promjer kotača prednji / stražnji	140 mm / 140 mm	140 mm / 140 mm
Materijal kućišta	Plastika	Plastika
Težina proizvoda	9,3 kg	8,9 kg
Funkcija malčiranja	-	-
Integrirana ručka za nošenje	•	•
Motor bez četkica	•	•
Ručka podesiva po visini	-	-
Sklopiva ručka	•	•
Košara za travu s indikatorom napunjenosti	-	-
Veliki kotači pogodni za travnjak	•	•
Broj baterija / punjača	1 / 1	0 / 0
Broj artikla	34.131.55	34.131.57

* Navedena pokrivenost područja temelji se na pretpostavci idealnih uvjeta



AKUMULATORSKA RUČNA KOSILICA



SILENT



	GE-HM 18/38 Li - Solo EXPERT
PXC baterija napon / kapacitet	18 V / –
Širina košnje	38 cm
Podešavanje visine košnje	4 postavke/ 14 - 38 mm
Kapacitet košare za travu	45 l
Broj oštrica	5
Promjer osovine za košnju	125 mm
Težina proizvoda	10,5 kg
Funkcija malčiranja	•
Integrirana ručka za nošenje	–
Motor bez četkica	–
Ručka podesiva po visini	•
Sklopiva ručka	•
Veliki kotači pogodni za travnjak	•
Broj baterija / punjača	0 / 0
Broj artikla	34.142.00



4 006825 641639

AKU UNIVERZALNI UREĐAJ ZA SIJANJE



3.3 l



	GE-US 18 Li - Solo EXPERT
PXC baterija napon / kapacitet	18 V / –
Kapacitet	3,3 l
Širina raspršivanja maks.	5 m
Pogodan za	Gnojivo, sjemenje trave, sol
Težina proizvoda	1,2 kg
Elektronska kontrola brzine (6 postavki)	•
Podešavanje protoka (8 postavki)	•
Individualno podesiva širina raspršivanja	•
Mekani rukohvat	•
Prikladno za šljunak za zimsko posipavanje	•
Broj baterija / punjača	0 / 0
Broj artikla	34.154.10



4 006825 638356

AKUMULATORSKI PROZRAČIVAČI TRAVE

VIŠE SNAGE I DULJE VRIJEME RADA

Osim ostalih prednosti, motor bez četkica jamči maksimalnu snagu uz dulje vrijeme rada po punjenju baterije

KUĆIŠTE JEDNOSTAVNO ZA ODRŽAVANJE

Robusno kućište izrađeno od materijala otpornog na udarce vrlo je jednostavno za održavanje zahvaljujući dizajnu bez rubova

CENTRALNO PODEŠAVANJE RADNE DUBINE

Centralno podešavanje radne dubine na 3 različite postavke omogućuje precizan rad kojim se izbjegava oštećenje korijena



PODESIVA I SKLOPIVA RUČKA

Ručka je podesiva po visini i ima položaj za parkiranje, što štedi prostor za pohranu. Sklapanje je brzo i jednostavno s polugama za brzo otpuštanje

Akumulatorski prozračivač trave
GE-SA 36/35 Li

INTEGRIRANA RUČKA ZA NOŠENJE

Integrirana ručka za nošenje olakšava transport

PROMJENA VALJKA BEZ DODATNOG ALATA

Valjci za prozračivanje mogu se brzo promijeniti bez ikakvog dodatnog alata

AKUMULATORSKI PROZRAČIVAČI TRAVE



	GE-SC 36/35 Li Brushless - Solo EXPERT NOVO	GE-SA 36/35 Li Brushless - Solo EXPERT NOVO
PXC baterija napon / kapacitet	2x 18 V / –	2x 18 V / –
Preporučeno za travnjake do cca.*	550 m ²	550 m ²
Radna širina	35 cm	35 cm
Podešavanje radne dubine	3 postavke (centralno) + parking pozicija	3 postavke (centralno) + parking pozicija
Broj oštrica	16 kom	16 kom
Promjer kotača prednji / stražnji	160 mm / 160 mm	160 mm / 160 mm
Materijal kućišta	Plastično kućište lako za održavati	Plastično kućište lako za održavati
Težina proizvoda	9,9 kg	11,3 kg
Broj kandži	–	24 kom
Prikladan za travnjak, veliki kotači	•	•
Motor bez četkica	•	•
Ručka podesiva po visini	• + parking pozicija	• + parking pozicija
Sklopiva ručka	•	•
Valjak za skarifikaciju / prozračivanje	• / proširivo po želji	• / •
Integrirana ručka za nošenje	•	•
Brzo otpušajući zatvarač na ručki	•	•
Promjena valjka bez alata	•	•
Košara	Proširivo po želji	•
Broj baterija / punjača	0 / 0	0 / 0
Broj artikla	34.206.80	34.206.85

* Navedena pokrivenost područja temelji se na pretpostavci idealnih uvjeta



4 006825 661439



4 006825 662375

AKUMULATORSKI PROZRAČIVAČI TRAVE

36 V
POWER
2 x 18 V



PURE POWER
BRUSHLESS



	GC-SC 36/31 Li - Solo CLASSIC	GC-SC 18/28 Li Brushless - Solo CLASSIC
PXC baterija napon / kapacitet	2x 18 V / -	18 V / -
Preporučeno za travnjake do cca.*	350 m ²	200 m ²
Radna širina	31 cm	28 cm
Podešavanje radne dubine	3 postavke + parking pozicija	3 postavke + parking pozicija
Broj oštrica	8 kom duplih noževa	12 kom
Promjer kotača prednji / stražnji	180 mm / 100 mm	150 mm / 100 mm
Materijal kućišta	Plastika	Plastika
Težina proizvoda	8,0 kg	6,6 kg
Broj kandži	-	-
Prikladan za travnjak, veliki kotači	•	•
Motor bez četkica	-	•
Ručka podesiva po visini	•	•
Sklopiva ručka	•	•
Valjak za skarifikaciju / valjak za prozračivanje	• / proširivo po želji	• / proširivo po želji
Integrirana ručka za nošenje	•	•
Brzo otpuštajući zatvarač na ručki	-	-
Košara	Proširivo po želji	Proširivo po želji
Broj baterija / punjača	0 / 0	0 / 0
Broj artikla	34.206.60	34.206.04

* Navedena pokrivenost područja temelji se na pretpostavci idealnih uvjeta



4 006825 636956



4 006825 655223



AKUMULATORSKA BUŠILICA ZA ZEMLJU



PUREPOWER
BRUSHLESS

	GP-EA 18/150 Li Brushless - Solo PROFESSIONAL
PXC baterija napon / kapacitet	18 V / -
Promjer bušenja	150 mm
Duljina svrdla	800 mm
Broj okretaja	125 min ⁻¹
Težina proizvoda	6,0 kg
Motor bez četkica	•
Promjena svrdla bez alata	•
Metalni okvir	•
Rotacija u lijevo/desno	•
Mekani rukohvat	•
Broj baterija / punjača	0 / 0
Broj artikla	34.370.00



4 006825 659023

PRIBOR ZA AKUMULATORSKE BUŠILICE ZA ZEMLJU



	Svrdlo 120 mm	Mješalica za žbuku	Produžetak
Pogodan za	GP-EA 18/150 Li Brushless	GP-EA 18/150 Li Brushless	GP-EA 18/150 Li Brushless
Broj artikla	34.370.10	34.370.11	34.370.12



4 006825 659030



4 006825 659047



4 006825 659054

AKUMULATORSKI
ČISTAČ SNIJEGAPURE POWER
BRUSHLESS36 V
POWER
2 x 18 V

	GE-ST 36/40 Li E Brushless - Solo EXPERT
PXC baterija napon / kapacitet	2x 18 V / -
Radna širina	40 cm
Maks. visina snijega	20 cm
Maks. udaljenost izbacivanja	6 m
Materijal kućišta	Plastika
Težina proizvoda	6,5 kg
Motor bez četkica	•
Podesivi smjer izbacivanja snijega	•
Elektronska kontrola brzine	•
Poklopac baterije	•
Pomoćna ručka	•
Integrirana ručka za nošenje	•
Mekani rukohvat	•
Samostojeći	•
Dvoručni sigurnosni prekidač	•
Broj baterija / punjača	0 / 0
Broj artikla	34.170.11



4 006825 659979



AKUMULATORSKE KOPAČICE



	GE-CR 30 Li - Solo EXPERT	GE-CR 18/20 Li E - Solo EXPERT
PXC baterija napon / kapacitet	2x 18 V / -	18 V / -
Radna širina	30 cm	20 cm
Radna dubina	200 mm	200 mm
Broj oštrica	4 kom	4 kom
Promjer noževa	200 mm	155 mm
Materijal kućišta	Plastika	Plastika
Težina proizvoda	11,0 kg	3,85 kg
Kotači podesivi po visini radi transporta	•	-
Ergonomska ručka	•	•
Sklopiva ručka	•	Odvojiva osovina
Elektronska kontrola brzine	-	•
Broj baterija / punjača	0 / 0	0 / 0
Broj artikla	34.312.00	34.312.10



4 006825 615203



4 006825 654974

AKUMULATORSKI TRIMERI ZA TRAVU (REZNA NIT + NOŽ)

PUREPOWER
BRUSHLESS

	AGILLO 36/255 EXPERT	AGILLO 18/200 EXPERT
PXC baterija napon / kapacitet	2x 18 V / -	18 V / -
Širina rezanja nožem	25,5 cm	20 cm
Širina rezanja reznom niti	30 cm	30 cm
Promjer rezne niti	2,0 mm	2,0 mm
Duljina rezne niti	8 m	8 m
Težina proizvoda	6,1 kg	6,5 kg
Motor bez četkica	•	-
Blokada osovine	•	•
Podesiva ručka	•	•
Odvojiva osovina	•	•
Dvostrana ručka	•	•
Elektronska kontrola brzine	•	•
Automatsko izvlačenje rezne niti	•	•
Zidni nosač	•	•
Broj baterija / punjača	0 / 0	0 / 0
Nož	•	•
Rezna nit	•	•
Udobni pojas za nošenje	•	•
Broj artikla	34.113.20	34.113.10



4 006825 629583



4 006825 651300

AKUMULATORSKI TRIMERI ZA TRAVU

ZIDNI NOSAČ

Jednostavno i sigurno skladištenje

ELEKTRONSKA KONTROLA BRZINE

Kontroliran i precizan rad

POMOĆNA RUČKA

Univerzalno podesiva pomoćna ručka omogućuje sigurno i udobno vođenje trimera

ODVOJIVA OSOVINA

Korisnički prilagođen sustav za odvajanje za brzo skladištenje koje štedi prostor i služi za jednostavan transport

MEKANI RUKOHVAT

Ergonomsko rukovanje bez zamaranja

Akumulatorski trimeri za travu
GE-CT 36/30 Li E

AKUMULATORSKI TRIMER ZA TRAVU

36 V
POWER
2 x 18 V



REZNA NIT

Jednostrana rezna nit s automatskim izvlačenjem nudi širinu rezanja do 30 cm

MOTOR NA DONJOJ STRANI

Optimalan prijenos snage i raspodjela težine

ŠTITNIK CVIJEĆA

Osigurava potreban sigurnosni razmak do cvijeća i ukrasnog bilja

GE-CT 36/30 Li E - Solo

EXPERT

PXC baterija napon / kapacitet	2x 18 V / -
Širina rezanja	30 cm
Promjer rezne niti	2,0 mm
Duljina rezne niti	8 m
Težina proizvoda	3,1 kg
Beskonačno podesiva dodatna ručka	•
Štitnik cvijeća	•
Automatsko izvlačenje rezne niti	•
Odvojiva osovin	•
Elektronska kontrola brzine	•
Mekani rukohvat	•
Zidni nosač	•
Broj baterija / punjača	0 / 0
Rezna nit	•
Pojas za nošenje	•
Broj artikla	34.113.00



4 006825 629187

AKUMULATORSKI TRIMERI ZA TRAVU



	GE-CT 18/30 Li - Solo EXPERT	GE-CT 18/28 Li TC - Solo EXPERT	GE-CT 18/28 Li - Solo EXPERT
PXC baterija napon / kapacitet	18 V / -	18 V / -	18 V / -
Širina rezanja	30 cm	28 cm	28 cm
Promjer rezne niti	1,6 mm	1,6 mm	1,6 mm
Duljina rezne niti	5 m	5 m	5 m
Težina proizvoda	2,1 kg	4,9 kg	2,3 kg
Podesiva dodatna ručka	•	•	•
Teleskopska drška	•	•	•
Okretna glava motora	90°	180°	180°
Nagibna glava motora	3 postavke	3 postavke	3 postavke
Štitnik cvijeća	•	•	•
Pretinac za plastične nožice	-	-	-
Mekani rukohvat	•	•	•
Kolica za trimer	-	•	-
Automatsko izvlačenje rezne niti	-	•	•
Broj baterija / punjača	0 / 0	0 / 0	0 / 0
Broj artikla	34.112.50	34.112.12	34.112.42



AKUMULATORSKI TRIMERI ZA TRAVU



	GE-CT 18 Li EXPERT	GE-CT 18 Li - Solo EXPERT
PXC baterija napon / kapacitet	18 V / 2,0 Ah	18 V / -
Vrijeme punjenja	40 min	-
Vrijeme rada	55 min	-
Širina rezanja	24 cm	24 cm
Težina proizvoda	2,2 kg	1,8 kg
Beskonačno podesiva dodatna ručka	•	•
Beskonačno podesiva teleskopska drška	•	•
Okretna glava motora +/- 90°	•	•
Nagibna glava motora	5 postavki	5 postavki
Štitnik cvijeća	•	•
Pretinac za plastične nožice	•	•
Mekani rukohvat	•	•
Broj baterija / punjača	1 / 1	0 / 0
Plastični nožići	• (20 kom)	• (20 kom)
Broj artikla	34.111.97	34.111.72



AKUMULATORSKI TRIMERI ZA TRAVU



	GC-CT 18/24 Li CLASSIC	GC-CT 18/24 Li - Solo CLASSIC	GC-CT 18/24 Li P CLASSIC	GC-CT 18/24 Li P - Solo CLASSIC
PXC baterija napon / kapacitet	18 V / 2,0 Ah	18 V / -	18 V / 1,5 Ah	18 V / -
Vrijeme punjenja	40 min	-	120 min	-
Vrijeme rada	55 min	-	40 min	-
Širina rezanja	24 cm	24 cm	24 cm	24 cm
Težina proizvoda	1,8 kg	1,3 kg	1,6 kg	1,2 kg
Beskonačno podesiva dodatna ručka	•	•	-	-
Beskonačno podesiva teleskopska drška	•	•	-	-
Okretna glava motora +/- 90°	-	-	-	-
Nagibna glava motora	-	-	-	-
Štitnik cvijeća	•	•	-	-
Pretinac za plastične nožice	-	-	-	-
Mekani rukohvat	-	-	-	-
Broj baterija / punjača	1 / 1	0 / 0	1 / 1	0 / 0
Plastični nožići	• (20 kom)	• (20 kom)	• (20 kom)	• (20 kom)
Broj artikla	34.111.25	34.111.23	34.111.02	34.111.04



AKUMULATORSKI TRIMER ZA RUBOVE TRAVNJAKA



	GE-LE 18/190 Li - Solo EXPERT
PXC baterija napon / kapacitet	18 V / -
Vrijeme punjenja	-
Vrijeme rada	-
Min dubina reza	36,5 mm
Maks. dubina reza	45 mm
Duljina noža	190 mm
Težina proizvoda	3,0 kg
Beskonačno podesiva dodatna ručka	•
Odvojiva osovina	•
Podešavanje dubine	•
Kotačići	•
Mekani rukohvat	•
Broj baterija / punjača	0 / 0
Broj artikla	34.243.00



4 006825 651287

AKUMULATORSKI UREĐAJI ZA ČIŠĆENJE FUGA



	GC-CC 18 Li CLASSIC	GC-CC 18 Li - Solo CLASSIC
PXC baterija napon / kapacitet	18 V / 2,0 Ah	18 V / -
Vrijeme punjenja	40 min	-
Vrijeme rada	45 min	-
Promjer četke	100 mm	100 mm
Težina proizvoda	2,4 kg	2,0 kg
Beskonačno podesiva dodatna ručka	•	•
Beskonačno podesiva teleskopska drška	•	•
Kotač za vođenje	•	•
Mekani rukohvat	•	•
Broj baterija / punjača	1 / 1	0 / 0
Čelična četka (15 mm širina)	•	•
Čelična četka (10 mm širina)	- (dostupno kao pribor)	- (dostupno kao pribor)
Najlonska četka (10 mm širina)	•	•
Najlonska četka (6 mm širina)	- (dostupno kao pribor)	- (dostupno kao pribor)
Broj artikla	34.240.51	34.240.50



4 006825 618396



4 006825 615982

AKUMULATORSKI UREĐAJ ZA ČIŠĆENJE TERASA

4u1 PRIMJENA

Čišćenje kamena, drva,
umjetne trave i kutova/rubova

UKLJ.

VENTIL ZA REGULACIJU VODE

Ekonomična potrošnja vode putem
mogućnosti ručne regulacije izravno
na uređaju



INTEGRIRANI PRIKLJUČAK ZA VRTNO CRIJEVO

Za temeljito, potpuno mokro
čišćenje potreban je samo
jedan korak

INTEGRIRANA BOČNA ČETKA

Idealno za granično čišćenje sve
do rubova



Aku uređaj za čišćenje terasa
PICOBELLA



ELEKTRONSKA KONTROLA BRZINE

Omogućuje prilagodbu bilo kojoj
površini

DODATNA RUČKA

S praktičnom vodilicom
za vrtno crijevo

ALUMINIJSKA TELESKOPSKA DRŠKA

Beskonačno podešavanje visine,
ovisno o visini korisnika

ZAMJENA ČETKE BEZ DODATNOG ALATA

Brzo i jednostavno pritiskom
na gumb

KRETANJE ČETKE NAPRIJED / NAZAD

Time se postiže bolji rezultat
čišćenja, glatka kontrola četke i
savršena zaštita od prskanja



SOFT četka



MEDIUM četka
(uklj. bočna četka)



ULTRA četka



ULTRA četka
(uklj. bočna četka)

PRIBOR ZA PICOBELLA



	SOFT četka	MEDIUM četka (uklj. bočna četka)	ULTRA četka	ULTRA četka (uklj. bočna četka)
Materijal	Najlon	Najlon	Čelični lim	Čelični lim
Promjer četke	115 mm	115 mm	115 mm	115 mm
Radna širina	195 mm	215 mm	195 mm	215 mm
Pogodan za	Drvo, umjetna trava	Kamen	Kamen (neosjetljivi)	Kamen (neosjetljivi)
Broj artikla	34.241.21	34.241.20	34.241.22	34.241.26



4 006825 646252



4 006825 646245



4 006825 646269



4 006825 660845

SAVRŠENE ČETKE ZA SVAKU POVRŠINU.



SOFT četka

- Drvo / WPC / BPC
- Umjetna trava

AKUMULATORSE ŠKARE ZA ŽIVICU

ROTIRAJUĆA STRAŽNJA RUČKA

Udoban i neumoran rad s okomitim rezovima

ERGONOMSKA PREDNJA RUČKA

Zahvaljujući nekoliko mikroprekidača, prednja je ručka ergonomski dizajnirana za rad bez zamora

METALNI PRIJENOS

Metalni prijenos osigurava učinkovit prijenos snage i dugi radni vijek

ZAŠTITA OD UDARACA

Zaštita od udaraca štiti nož i radnu površinu od oštećenja

SAKUPLJAČ ŽIVICE

Zahvaljujući praktičnom sakupljaču, ostaci odrezane živice mogu se savršeno ukloniti s vrha živice prilikom rezanja

ALUMINIJSKI POKLOPAC OŠTRICA

Proizvod je opremljen sa čvrstim aluminijskim poklopcem za zaštitu oštrica

VISOKOKVALITETNE OŠTRICE

Laserski rezane i dijamantno brušene oštrice dizajnirane su za maksimalnu preciznost i izdržljivost

Aku škare za živicu
GE-CH 36/65 Li

AKUMULATORSE ŠKARE ZA ŽIVICU

36 V
POWER
2 x 18 V

LONG LASTING SHARPNESS
LASERCUT & DIAMOND GROUND



	GE-CH 36/65 Li - Solo EXPERT	GE-CH 36/61 Li - Solo EXPERT
PXC baterija napon / kapacitet	2x 18 V / -	2x 18 V / -
Vrijeme punjenja	-	-
Vrijeme rada	-	-
Duljina mača	720 mm	670 mm
Duljina reza	650 mm	610 mm
Razmak između zuba	30 mm	26 mm
Težina proizvoda	4,0 kg	2,8 kg
Rotirajuća stražnja ručka	•	-
Ergonomska prednja ručka s nekoliko mikro prekidača	•	•
Sakupljač živice	•	•
Laserski rezane i dijamantom brušene oštrice	•	•
Metalni prijenos	•	•
Mekani rukohvat	•	•
Aluminijski štitičnik oštrica	•	•
Broj baterija / punjača	0 / 0	0 / 0
Zaštitni poklopac s nosačem za zid	•	•
Broj artikla	34.109.60	34.109.65



4 006825 639018



4 006825 662382

AKUMULATORSKE ŠKARE ZA ŽIVICU



	GE-CH 18/60 Li - Solo EXPERT	ARCURRA 18/55 EXPERT
PXC baterija napon / kapacitet	18 V / -	18 V / -
Vrijeme punjenja	-	-
Vrijeme rada	-	-
Duljina mača	670 mm	620 mm
Duljina reza	600 mm	550 mm
Razmak između zuba	22 mm	18 mm
Težina proizvoda	2,9 kg	2,8 kg
Rotirajuća stražnja ručka	•	-
Ergonomska prednja ručka s nekoliko mikro prekidača	•	•
Sakupljač živice	•	•
Laserski rezane i dijamantom brušene oštrice	•	•
Metalni prijenos	•	•
Mekani rukohvat	•	•
Aluminijski štitičnik oštrica	•	•
Broj baterija / punjača	0 / 0	0 / 0
Zaštitni poklopac s nosačem za zid	•	•
Broj artikla	34.109.30	34.109.20



4 006825 635942



4 006825 635935

AKUMULATORSKE ŠKARE ZA ŽIVICU



	GC-CH 1855/1 Li CLASSIC	GC-CH 1855/1 Li - Solo CLASSIC	GC-CH 18/50 Li - Solo CLASSIC NOVO
PXC baterija napon / kapacitet	18 V / 2,5 Ah	18 V / -	18 V / -
Vrijeme punjenja	50 min	-	-
Vrijeme rada	100 min	-	-
Duljina mača	620 mm	620 mm	550 mm
Duljina reza	550 mm	550 mm	500 mm
Razmak između zuba	18 mm	18 mm	17 mm
Težina proizvoda	2,6 kg	2,4 kg	2,2 kg
Rotirajuća stražnja ručka	•	•	•
Ergonomska prednja ručka s nekoliko mikro prekidača	-	-	-
Sakupljač živice	•	•	-
Laserski rezane i dijamantom brušene oštrice	•	•	•
Metalni prijenos	•	•	•
Mekani rukohvat	•	•	•
Aluminijski štitičnik oštrica	•	•	•
Broj baterija / punjača	1 / 1	0 / 0	0 / 0
Zaštitni poklopac s nosačem za zid	•	•	•
Broj artikla	34.105.06	34.105.02	34.109.45



4 006825 661910



4 006825 615937



4 006825 664522

AKUMULATORSKE ŠKARE ZA ŽIVICU

LONG LASTING SHARPNESS

LASERCUT & DIAMOND GROUND



	GC-CH 1846 Li CLASSIC	GC-CH 1846 Li - Solo CLASSIC	GC-CH 18/40 Li - Solo CLASSIC
PXC baterija napon / kapacitet	18 V / 2,0 Ah	18 V / -	18 V / -
Vrijeme punjenja	40 min	-	-
Vrijeme rada	80 min	-	-
Duljina mača	520 mm	520 mm	475 mm
Duljina reza	460 mm	460 mm	400 mm
Razmak između zuba	15 mm	15 mm	13 mm
Težina proizvoda	2,3 kg	2,0 kg	2,0 kg
Rotirajuća stražnja ručka	-	-	-
Ergonomska prednja ručka s nekoliko mikro prekidača	-	-	-
Sakupljač živice	-	-	-
Laserski rezane i dijamantom brušene oštrice	•	•	•
Metalni prijenos	•	•	•
Mekani rukohvat	•	•	•
Aluminijski štitičnik oštrica	•	•	•
Broj baterija / punjača	1 / 1	0 / 0	0 / 0
Zaštitni poklopac s nosačem za zid	•	•	•
Broj artikla	34.106.83	34.106.42	34.109.40



4 006825 615432



4 006825 588293



4 006825 661125

AKU TRESAČ MASLINA I PLODOVA

JESEN 2023



	GE-FS 18/53 Li - Solo EXPERT	NOVO
PXC baterija napon / kapacitet	18 V / -	
Vrijeme punjenja	-	
Vrijeme rada	-	
Maks. radna širina	53 cm	
Min. radna širina	28 cm	
Duljina šiljaka	31 cm	
Težina proizvoda	4,2 kg	
Beskonačno podesiva aluminijska teleskopska drška	•	
Pomoćna ručka	•	
Dodatna površina za držanje	•	
Izmjenjivi karbonski šiljci	•	
Broj baterija / punjača	0 / 0	
Broj artikla	34.114.00	



4 006825 670738

AKU VIŠENAMJENSKI VRTNI ALAT

4in1

 - MÄHEN
- TRIMMEN
- SCHNEIDEN
- ENTASTEN

36 V
POWER
2 x 18 V

PUREPOWER
BRUSHLESS

GE-LM 36/4in1 Li Brushless - Solo	
EXPERT	
PXC baterija napon / kapacitet	2x 18 V / -
Lančana pila duljina mača	200 mm
Lančana pila brzina reza	10 m/s
Škare za živicu duljina mača	450 mm
Škare za živicu razmak zuba	24 mm
Trimer za travu širina rezanja nožem	255 mm
Trimer za travu širina rezanja reznom niti	330 mm
Maks. radna visina	3,5 m (lančana pila) / 3,5 m (škare za živicu)
Težina proizvoda	9,0 kg (uklj. sve dodatke)
Motor bez četkica	•
Aluminijska teleskopska drška s produžetkom	•
Laserski rezane i dijamantom brušene oštrice	•
Nagibni nastavak škara za živicu	•
OREGON kvalitetni mač i lanac	•
Automatsko podmazivanje lanca	•
Automatsko izvlačenje rezne niti	•
Podesiva dodatna ručka	•
Remen za nošenje s brzim otpuštanjem	•
Broj baterija / punjača	0 / 0
Zaštitni poklopac s nosačem za zid	•
Broj artikla	34.109.01



4 006825 651638

AKU VIŠENAMJENSKI VRTNI ALATI

 FITTED WITH
OREGON
CHAIN AND BAR

**LONG LASTING
SHARPNESS**
**LASERCUT &
DIAMOND GROUND**

90°

**WERKZEUGKOPF
DREHBAR - PATENTIERT**

90°

**WERKZEUGKOPF
DREHBAR - PATENTIERT**

GE-HC 18 Li T		GE-HC 18 Li T - Solo	
EXPERT		EXPERT	
PXC baterija napon / kapacitet	18 V / 3,0 Ah	18 V / -	
Vrijeme punjenja	60 min	-	
Vrijeme rada	40 min	-	
Lančana pila duljina mača	200 mm	200 mm	
Lančana pila brzina reza	3,76 m/s	3,76 m/s	
Škare za živicu duljina mača	450 mm	450 mm	
Škare za živicu razmak zuba	16 mm	16 mm	
Maks. radna visina	4,0 m (lančana pila) / 3,5 m (škare za živicu)	4,0 m (lančana pila) / 3,5 m (škare za živicu)	
Težina proizvoda	6,3 kg (uklj. sve dodatke)	5,2 kg (uklj. sve dodatke)	
Aluminijska teleskopska drška s produžetkom	•	•	
Glavna drška i glava motora nagibne u nekoliko pozicija	•	•	
OREGON kvalitetni mač i lanac	•	•	
Zatezanje i izmjena lanca bez dodatnog alata	•	•	
Rotirajući nastavak lančane pile za vodoravne rezove	•	•	
Automatsko podmazivanje lanca	•	•	
Laserski rezane i dijamantom brušene oštrice	•	•	
Podesiva dodatna ručka	•	•	
Broj baterija / punjača	1 / 1	0 / 0	
Broj artikla	34.108.05	34.108.00	



4 006825 601329



4 006825 601275

AKU TELESKOPSKE LANČANE PILE

FITTED WITH
OREGON
CHAIN AND BAR



	GE-LC 18 Li T - Solo EXPERT	GC-LC 18/20 Li T - Solo CLASSIC
PXC baterija napon / kapacitet	18 V / -	18 V / -
Duljina mača	200 mm	200 mm
Duljina reza	170 mm	195 mm
Brzina reza	3,76 m/s	5,5 m/s
Maks. radna visina	4,0 m	4,0 m
Težina proizvoda	4,0 kg	3,4 kg
Beskonačno podesiva aluminijaska teleskopska drška	•	-
Aluminijaska teleskopska drška s produžetkom	-	•
Glavna drška i glava motora nagibne u nekoliko pozicija	•	-
OREGON kvalitetni mač i lanac	•	•
Zatezanje i izmjena lanca	Bez alata	S alatom
Rotirajući nastavak motorne pile za vodoravne rezove	•	-
Automatsko podmazivanje lanca	•	•
Graničnik	•	•
Metalni prijenos	•	•
Podesiva dodatna ručka	•	-
Dodatna površina za držanje	-	•
Broj baterija / punjača	0 / 0	0 / 0
Broj artikla	34.108.10	34.105.81



4 006825 604337



4 006825 652123

PRIBOR ZA AKUMULATORSKE TELESKOPSKE LANČANE PILE



	Škare za živicu ACCESSORY
Pogodno za	GE-LC 18 Li T
Težina proizvoda	1,4 kg
Broj artikla	34.108.18



4 006825 624649

AKU TELESKOPSKJE ŠKARE ZA ŽIVICU



	GE-HH 18/45 Li T - Solo EXPERT	GC-HH 18/45 Li T - Solo CLASSIC
PXC baterija napon / kapacitet	18 V / -	18 V / -
Duljina mača	450 mm	450 mm
Duljina reza	400 mm	410 mm
Razmak između zuba	16 mm	18 mm
Maks. radna visina	3,5 m	3,5 m
Težina proizvoda	4,3 kg	3,2 kg
Beskonačno podesiva aluminijska teleskopska drška	•	-
Aluminijska teleskopska drška s produžetkom	-	•
Glava motora nagibna u nekoliko pozicija	•	•
Glavna ručka nagibna u nekoliko pozicija	•	-
Laserski rezane i dijamantom brušene oštrice	•	•
Metalni prijenos	•	•
Podesiva dodatna ručka	•	-
Rotirajuća stražnja ručka	-	•
Dodatna površina za držanje	-	•
Broj baterija / punjača	0 / 0	0 / 0
Broj artikla	34.108.66	34.105.85



4 006825 630602



4 006825 652130

PRIBOR ZA AKUMULATORŠKE TELESKOPSKJE ŠKARE ZA ŽIVICU



	Lančana pila ACCESSORY
Pogodno za	GE-HH 18/45 Li T
Težina proizvoda	1,2 kg
Broj artikla	34.108.35



4 006825 624656

AKUMULATORSKE LANČANE PILE

GORNJA RUČKA

Zbog pozicije glavne ručke iznad motorne pile ona je optimalno uravnotežena i kompaktna, što je čini savršenom za njegu drveća i rezanje stabala

ERGONOMSKA RUČKA

S mekanim rukohvatom

Aku jednoručna lančana pila
FORTEXXA 18/20 TH*

ZATEZANJE I IZMJENA LANCA BEZ ALATA

Lako i brzo mijenjanje i zatezanje lanca za savršene rezultate rezanja

AKU JEDNORUČNA LANČANA PILA

PUREPOWER
BRUSHLESS

FITTED WITH
OREGON
CHAIN AND BAR



METALNI GRANIČNIK

Robusni metalni graničnik podržava sigurno i precizno vođenje pile

ZAŠTITA OD POVRATNOG UDARCA

Osiguravanje sigurnosti zahvaljujući velikoj zaštiti za ruke s trenutnom kočnicom lanca

AUTOMATSKO PODMAZIVANJE LANCA

Za neometan rad i dugi radni vijek

ZAŠTITA VRHA PILE

Kako biste smanjili rizik od povratnog udarca, a također je olakšano i rezanje grane odozdo

OREGON KVALITETNI MAČ I LANAC

Oregon mač i lanac omogućuju rad bez napora i savršene rezultate rezanja

VIŠE SNAGE I DULJE VRIJEME RADA

Osim ostalih prednosti, motor bez četkica jamči maksimalnu snagu uz dulje vrijeme rada po punjenju baterije



	FORTEXXA 18/20 TH PROFESSIONAL
PXC baterija napon / kapacitet	18 V / -
Duljina mača	200 mm
Duljina reza	140 mm
Brzina reza	7 m/s
Kapacitet spremnika za ulje	75 ml
Težina proizvoda	2,5 kg
Motor bez četkica	•
OREGON kvalitetni mač i lanac	•
Zatezanje i izmjena lanca bez dodatnog alata	•
Automatsko podmazivanje lanca	•
Robusni metalni graničnik	•
Zaštita od povratnog udarca + trenutna kočnica lanca	•
Osigurač lanca	•
Mekani rukohvat	•
Veliki otvor za punjenje ulja	•
Zaštita vrha	•
Broj baterija / punjača	0 / 0
Zaštitni poklopac	•
Broj artikla	46.000.20



* UPOZORENJE: Ovu motornu pilu smiju koristiti isključivo obučeni radnici za njegu drveća. Korištenje bez obuke može dovesti do ozbiljnih ozljeda.

AKUMULATORSKA LANČANA PILA

36 V
POWER
2 x 18 V

FITTED WITH
OREGON
CHAIN AND BAR

PUREPOWER
BRUSHLESS



GP-LC 36/35 Li Brushless - Solo

PROFESSIONAL

PXC baterija napon / kapacitet	2x 18 V / -
Duljina mača	350 mm
Duljina reza	330 mm
Brzina reza	15 m/s
Kapacitet spremnika za ulje	115 ml
Težina proizvoda	4,0 kg
Motor bez četkica	•
OREGON kvalitetni mač i lanac	•
Zatezanje i izmjena lanca bez dodatnog alata	•
Automatsko podmazivanje lanca	•
Robusni metalni graničnik	•
Zaštita od povratnog udarca + trenutna kočnica lanca	•
Osigurač lanca	•
Mekani rukohvat	•
Veliki otvor za punjenje ulja	•
Broj baterija / punjača	0 / 0
Zaštitni poklopac	•
Broj artikla	45.017.80



4 006825 631920

AKUMULATORSKE LANČANE PILE

FITTED WITH
OREGON
CHAIN AND BAR

PUREPOWER
BRUSHLESS



	FORTEXXA 18/30 EXPERT	GE-LC 18/25-1 Li EXPERT	GE-LC 18/25 Li - Solo EXPERT
PXC baterija napon / kapacitet	18 V / -	18 V / 3,0 Ah	18 V / -
Vrijeme punjenja	-	60 min	-
Vrijeme rada	-	100 rezova / 70x70 mm drvena građa	-
Duljina mača	300 mm	250 mm	250 mm
Duljina reza	270 mm	230 mm	230 mm
Brzina reza	8,9 / 6 m/s	4,5 m/s	4,5 m/s
Kapacitet spremnika za ulje	160 ml	200 ml	200 ml
Težina proizvoda	4,0 kg	3,0 kg	2,9 kg
Motor bez četkica	•	-	-
OREGON kvalitetni mač i lanac	•	•	•
Zatezanje i izmjena lanca bez dodatnog alata	•	•	•
Automatsko podmazivanje lanca	•	•	•
Podesiva brzina reza (Brzo/Eco)	•	-	-
Robusni metalni graničnik	•	•	•
Zaštita od povratnog udarca + trenutna kočnica lanca	•	•	•
Osigurač lanca	•	•	•
Mekani rukohvat	•	•	•
Veliki otvor za punjenje ulja	•	•	•
Broj baterija / punjača	0 / 0	1 / 1	0 / 0
Zaštitni poklopac	•	•	•
Broj artikla	46.000.10	45.017.60	45.017.61



4 006825 656572



4 006825 608335



4 006825 608342

AKUMULATORSKI OŠTRAČ LANACA



GE-CS 18 Li - Solo

EXPERT

PXC baterija napon / kapacitet	18 V / -
Promjer brusne ploče (unutarnji)	23 mm
Promjer brusne ploče (vanjski)	108 mm
Debljina brusne ploče	3,2 mm
Težina proizvoda	1,7 kg
Graničnik dubine	•
Skala za precizne postavke kuta brušenja	•
LED svjetlo	•
Uređaj za stezanje	•
Broj baterija / punjača	0 / 0
Broj artikla	44.999.40



4 006825 613858

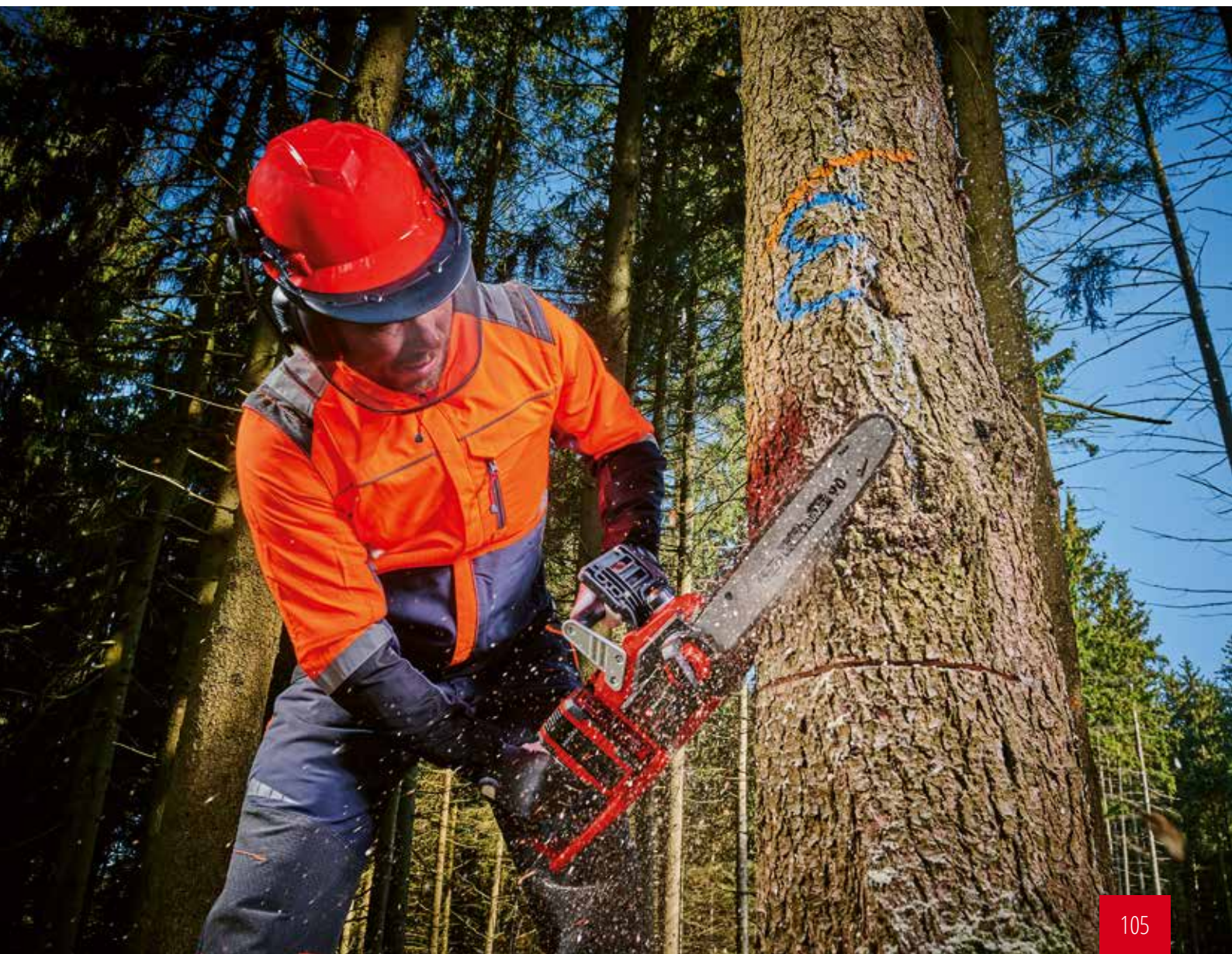

AKUMULATORSKI PUHAČI LIŠĆA

VIŠE SNAGE I DULJE VRIJEME RADA

Osim ostalih prednosti, motor bez četkica jamči maksimalnu snagu uz dulje vrijeme rada po punjenju baterije



PODESIVA I ODVOJIVA CIJEV

Omogućuje idealnu prilagodbu visini korisnika i štedi prostor za pohranu

ROBUSNI METALNI PRSTEN

Štiti od oštećenja i produljuje vijek trajanja

TURBO FUNKCIJA

Za maksimalnu učinkovitost puhanja, npr. za pomicanje vlažnog lišća bez napora

Akumulatorski puhač lišća
GP-LB 36/210 Li E Brushless

ELEKTRONSKA KONTROLA BRZINE

Prava brzina za svaku primjenu

UKLJ. POJAS ZA NOŠENJE

Ugodan rad bez bolova u leđima

AKUMULATORSKI PUHAČ LIŠĆA



36 V
POWER
2 x 18 V



GP-LB 36/210 Li E Brushless - Solo

PROFESSIONAL

PXC baterija napon / kapacitet	2x 18 V / -
Vrijeme punjenja	-
Vrijeme rada	-
Maks. protok puhanja zraka	210 km/h
Maks. snaga puhanja	816 m³/h
Broj okretaja	10000 - 22300 min ⁻¹
Težina proizvoda	2,4 kg
Motor bez četkica	•
Turbo funkcija	•
Elektronska kontrola brzine	•
Pojas za nošenje	•
Mekani rukohvat	•
Broj baterija / punjača	0 / 0
Broj artikla	34.336.20



4 006825 638967

AKUMULATORSKI PUHAČI LIŠĆA



	GP-LB 18/200 Li GK Brushless - Solo PROFESSIONAL	GP-LB 18/200 Li E Brushless - Solo PROFESSIONAL
PXC baterija napon / kapacitet	18 V / -	18 V / -
Vrijeme punjenja	-	-
Vrijeme rada	-	-
Maks. protok puhanja zraka	200 km/h	200 km/h
Maks. snaga puhanja	670 m³/h	670 m³/h
Broj okretaja	13000 - 18000 min ⁻¹	13000 - 18000 min ⁻¹
Težina proizvoda	2,2 kg	2,2 kg
Motor bez četkica	•	•
Turbo funkcija	•	•
Elektronska kontrola brzine	•	•
Pojas za nošenje	-	-
Mekani rukohvat	•	•
Set za čišćenje oluka	•	- (dostupno kao pribor)
Broj baterija / punjača	0 / 0	0 / 0
Broj artikla	34.335.50	34.335.55



4 006825 658965



4 006825 660616



AKUMULATORSKI PUHAČI LIŠĆA



	GC-CL 18 Li E CLASSIC	GC-CL 18 Li E - Solo CLASSIC
PXC baterija napon / kapacitet	18 V / 2,0 Ah	18 V / -
Vrijeme punjenja	40 min	-
Vrijeme rada	14 - 240 min	-
Maks. protok puhanja zraka	210 km/h	210 km/h
Maks. snaga puhanja	105 m ³ /h	105 m ³ /h
Broj okretaja	1400 - 12000 min ⁻¹	1400 - 12000 min ⁻¹
Težina proizvoda	1,7 kg	1,3 kg
2-dijelna cijev	-	-
Motor bez četkica	-	-
Elektronska kontrola brzine	•	•
Pojas za nošenje	-	-
Mekani rukohvat	•	•
Broj baterija / punjača	1 / 1	0 / 0
Broj artikla	34.335.33	34.335.32



AKUMULATORSKI UNIVERZALNI PUHAČ



	GE-UB 18/250 Li E - Solo EXPERT
PXC baterija napon / kapacitet	18 V / -
Vrijeme punjenja	-
Vrijeme rada	-
Maks. protok puhanja zraka	250 km/h
Maks. snaga puhanja	120 m ³ /h
Broj okretaja	6500 - 15000 min ⁻¹
Težina proizvoda	1,1 kg
2-dijelna cijev	•
Motor bez četkica	-
Elektronska kontrola brzine	• (LED)
Pojas za nošenje	-
Mekani rukohvat	•
Broj baterija / punjača	0 / 0
Broj artikla	34.335.42



AKUMULATORSKI USISAVAČI/PUHAČI LIŠĆA

SJECKALICA S OTVOROM ZA ČIŠĆENJE

Jednostavan pristup rotoru za uklanjanje ostataka

PROMJENA FUNKCIJE BEZ DODATNOG ALATA

Brzo i jednostavno prebacivanje između funkcije puhanja i usisavanja

ZIDNI NOSAČ

Integrirani nosač za pohranu koja štedi prostor

KVALITETNA VREĆA ZA LIŠĆE

Velika vreća za lišće s prozorom za potpunu kontrolu

AKUMULATORSKI USISAVAČ/PUHAČ LIŠĆA

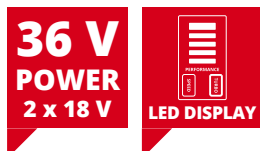

Aku usisavač/puhač lišća
VENTURRO 36/240

KONTROLA BRZINE S TURBO PREKIDAČEM

Postavite pravu brzinu puhanja i usisavanja za svaku primjenu. Turbo prekidač za maksimalnu učinkovitost kod mokrog lišća. Praktični LED zaslon prikazuje odabranu razinu

SUSTAV BRZOG PRIČVRŠĆIVANJA

Pametna priključak vreće za lišće na klik sistem olakšava pražnjenje

KOTAČI ZA VOĐENJE (PODESIVI PO VISINI)

Poboljšano rasterećenje težine kroz mogućnost guranja, čak i na neravnom terenu

UKLJ. POJAS ZA NOŠENJE

Ugodan rad bez bolova u leđima

VIŠE SNAGE I DULJE VRIJEME RADA

Osim ostalih prednosti, motor bez četkica jamči maksimalnu snagu uz dulje vrijeme rada po punjenju baterije



VENTURRO 36/240

PROFESSIONAL

NOVO

PXC baterija napon / kapacitet	2x 18 V / -
Maks. protok puhanja zraka	240 km/h
Maks. usisna snaga	740 m³/h
Broj okretaja	8000 - 15000 min ⁻¹
Funkcija sjeckanja	10:1
Kapacitet vreće za lišće	45 l
Težina proizvoda	3,6 kg
Promjena usisavanje / puhanje bez upotrebe alata	•
Motor bez četkica	•
Turbo funkcija	•
Elektronska kontrola brzine	•
Pomoćna ručka	•
Otvor za čišćenje sa sigurnosnim prekidačem	•
Kotači za vođenje	• (podesivi po visini)
Vreća za lišće s prozorom	•
Pojas za nošenje	•
Mekani rukohvat	•
Broj baterija / punjača	0 / 0
Broj artikla	34.336.40



AKUMULATORSKI USISAVAČI/PUHAČI LIŠĆA

**36 V
POWER
2 x 18 V**



	GE-CL 36 Li E Brushless - Solo EXPERT	GE-CL 36/230 Li E - Solo EXPERT
PXC baterija napon / kapacitet	2x 18 V / -	2x 18 V / -
Maks. protok puhanja zraka	210 km/h	230 km/h
Maks. usisna snaga	720 m³/h	700 m³/h
Broj okretaja	8000 - 13000 min ⁻¹	8000 - 14000 min ⁻¹
Funkcija sjeckanja	10:1	10:1
Kapacitet vreće za lišće	45 l	45 l
Težina proizvoda	3,4 kg	3,1 kg (puhač) / 4,4 kg (usisavač)
Promjena usisavanje / puhanje bez upotrebe alata	•	•
Motor bez četkica	•	-
Turbo funkcija	-	•
Elektronska kontrola brzine	•	•
Pomoćna ručka	• (podesiva)	• (podesiva)
Otvor za čišćenje sa sigurnosnim prekidačem	-	-
Kotači za vođenje	•	• (podesivi po visini)
Vreća za lišće s prozorom	•	•
Pojas za nošenje	•	•
Mekani rukohvat	•	•
Broj baterija / punjača	0 / 0	0 / 0
Broj artikla	34.336.00	34.336.30



4 006825 613391



4 006825 646511

AKUMULATORSKI USISAVAČ/PUHAČ LIŠĆA

**LOW WEIGHT
EASY HANDLING**

**AIR SPEED
MIN - MAX**



	VENTURRO 18/210 EXPERT	NOVO
PXC baterija napon / kapacitet	18 V / -	
Maks. protok puhanja zraka	210 km/h	
Maks. usisna snaga	500 m³/h	
Broj okretaja	8000 - 14000 min ⁻¹	
Funkcija sjeckanja	10:1	
Kapacitet vreće za lišće	45 l	
Težina proizvoda	3,0 kg	
Promjena usisavanje / puhanje bez upotrebe alata	•	
Motor bez četkica	•	
Turbo funkcija	-	
Elektronska kontrola brzine	•	
Pomoćna ručka	•	
Otvor za čišćenje sa sigurnosnim prekidačem	-	
Kotači za vođenje	•	
Vreća za lišće s prozorom	•	
Pojas za nošenje	•	
Mekani rukohvat	•	
Broj baterija / punjača	0 / 0	
Broj artikla	34.336.25	



4 006825 663631

AKUMULATORSKA PILA ZA GRANE



	GE-GS 18/150 Li - Solo	NOVO
	EXPERT	
PXC baterija napon / kapacitet	18 V / -	
Duljina lista pile	150 mm	
Kapacitet rezanja s drškom za grane	80 mm	
Kapacitet rezanja bez drške za grane	100 mm	
Težina proizvoda	1,3 kg	
Zamjena lista pile bez upotrebe dodatnog alata	•	
Odjeljiva drška za grane	•	
Specijalni prihvat baterije za smanjenje vibracija	•	
Metalni prijenos za dugi životni vijek	•	
Mekani rukohvat	•	
Kopča za remen	•	
KWB visokokvalitetni list pile	2x	
Broj baterija / punjača	0 / 0	
Broj artikla	34.082.90	



4 006825 666649

AKUMULATORSKE ŠKARE ZA OBREZIVANJE



	GE-LS 18 Li - Solo	
	EXPERT	
PXC baterija napon / kapacitet	18 V / -	
Maks. kapacitet rezanja	28 mm	
Težina proizvoda	0,8 kg	
Visokokvalitetne oštrice za učinkovit rad	•	
Kopča za remen	•	
Klizni prekidač za zatvaranje / otvaranje oštrica	•	
Stabilan plastični poklopac	•	
Ergonomska ručka s mekanim rukohvatom	•	
Broj baterija / punjača	0 / 0	
Broj artikla	34.083.00	



4 006825 652727

AKUMULATORSKE TLAČNE PRSKALICE



	GE-WS 18/150 Li - Solo EXPERT	GE-WS 18/75 Li - Solo EXPERT
PXC baterija napon / kapacitet	18 V / –	18 V / –
Kapacitet spremnika	15 l	7,5 l
Maks. tlak pumpe	4,5 bara	2,5 bara
Duljina tlačnog crijeva	1400 mm	1400 mm
Maks. temperatura tekućine	40°C	40°C
Težina proizvoda	4,4 kg	2,4 kg
Automatska pumpa, bez potrebe za ručnim povećanjem tlaka	•	•
Transparentni spremnik sa skalom	•	•
Individualno podesiva mjedena mlaznica	•	•
Teleskopska cijev od nehrđajućeg čelika	–	•
Poklopac baterije - pruža zaštitu od prodora vode	•	•
Cijev za prskanje s funkcijom konstantnog rada	•	•
Velika metalna kopča za otvaranje/zatvar. spremnika	–	•
Podstavljeni remen za nošenje	•	•
Veliki otvor za punjenje	•	–
Broj baterija / punjača	0 / 0	0 / 0
Broj artikla	34.252.30	34.252.20



AKUMULATORSKE TLAČNE PRSKALICE

JESEN
2023



	GE-WS 18/35 Li - Solo EXPERT	GE-WS 18/10 Li - Solo EXPERT NOVO
PXC baterija napon / kapacitet	18 V / –	18 V / –
Kapacitet spremnika	3,5 l	1,0 l
Maks. tlak pumpe	2,5 bara	2,5 bara
Duljina tlačnog crijeva	1400 mm	–
Maks. temperatura tekućine	40°C	50°C
Težina proizvoda	2,2 kg	0,9 kg
Automatska pumpa, bez potrebe za ručnim povećanjem tlaka	•	•
Transparentni spremnik sa skalom	•	•
Individualno podesiva mjedena mlaznica	•	•
Teleskopska cijev od nehrđajućeg čelika	•	–
Poklopac baterije - pruža zaštitu od prodora vode	•	–
Cijev za prskanje s funkcijom konstantnog rada	•	–
Velika metalna kopča za otvaranje/zatvar. spremnika	•	•
Podstavljeni remen za nošenje	•	–
Veliki otvor za punjenje	–	–
Broj baterija / punjača	0 / 0	0 / 0
Broj artikla	34.252.10	34.252.40



PRIBOR ZA AKU TLAČNE PRSKALICE



	Komplet pribora za tlačne prskalice ACCESSORY
Teleskopska drška	1 - 2 m
Težina proizvoda	0,25 kg
Teleskopska cijev od nehrđajućeg čelika	•
Plastično zvono s raspršivačem	•
Broj artikla	34.252.05



4 006825 664003



	Spremnik 7,5 Litara ACCESSORY
Kapacitet spremnika	7,5 l
Težina proizvoda	0,8 kg
Transparentni spremnik sa skalom	•
Veliki metalne kopče na spremniku - jednostavno otvaranje/zatvaranje	•
Broj artikla	34.252.06



4 006825 664065

AKUMULATORSKI VENTILATOR



	GE-CF 18/2200 Li EXPERT NOVO
PXC baterija napon / kapacitet	18 V / -
Broj okretaja	1200 / 1700 / 2200 rpm
Snaga puhanja	15000 m/h
Promjer ventilatora	180 mm
Težina proizvoda	1,2 kg
360° podešavanje	•
Ručka za nošenje	•
Različite mogućnosti montaže	•
Broj baterija / punjača	0/0
Broj artikla	34.080.35



4 006825 665253

POJAS ZA PXC BATERIJE

MULTI-FUNCTIONAL:
FOR 36 V AND FOR 18 V DEVICES



	GE-PB 36/18 Li EXPERT
PXC baterija napon / kapacitet	Pogodno za 18 V i 2x 18 V primjenu
Broj utora za baterije	2 kom
Duljina kabela	150 cm
Duljina pojasa	150 cm
Težina proizvoda	1,7 kg
Podstavljeni remen za nošenje	•
Velika kopča za otvaranje i zatvaranje	•
Kuka za kabel	•
Drugi utor za bateriju se može ukloniti	•
Broj baterija / punjača	0 / 0
Broj artikla	34.083.10



AKUMULATORSKI PLINSKI GRIJAČ



	GE-HG 18/370 Niro Li - Solo HEATING
PXC baterija napon / kapacitet	18 V / -
Izlazna snaga grijanja	37 kW
Protok zraka	1000 m ³ /h
Potrošnja plina	2693 g/h
Maks. radni tlak	1,5 bara
Plinska boca	5 kg - 11 kg propan-butan
Vrsta plina	Propan, butan ili mješavine propan-butana
Težina proizvoda	4,65 kg
Kućište od nehrđajućeg čelika	•
Okvir grijača od pocinčanog čeličnog lima	•
Piezo paljenje	•
On/Off prekidač	•
Zaštita od povratnog plamena + piezo električni odvodnik plamena	•
Solenoidni ventil + tipka za plinski ventil	•
Odobreno za upotrebu u	DE + AT
Broj baterija / punjača	0 / 0
Pribor	Regulator pritiska 1500 mbar + plinsko crijevo
Broj artikla	23.308.05



AKUMULATORSKA AUTOMATSKA VRTNA PUMPA

INDIKATOR USISAVANJA

Pružuje informacije o trenutnoj visini usisavanja/uisisnom tlaku ili mogućim problemima usisavanja

INDIKATOR PUNJENJA VODOM / PRLJAVŠTINE

Prozirno kućište na prvi pogled pokazuje da li je i koliko vode napunjeno u pumpu i da li je predfilter zaprljan

Aku automatska vrtna pumpa
AQUINNA 36/38 F LED AUTOMATIC

VISOKOKVALITETNI NAVOJI

Dugi vijek trajanja navoja i pumpe

ZAŠTITA OD SMRZAVANJA

Jednostavan odvod zaostale vode i zaštita od smrzavanja zahvaljujući vijku za odvod vode

PREKIDAČ RAZINE SNAGE

ECO i BOOST način rada: prilagodba performansi odgovarajućoj primjeni

LED INDIKATOR KAPACITETA BATERIJE

Čitajte preostali kapacitet baterije na prvi pogled izravno na uređaju bez otvaranja poklopca baterije

AUTOMATSKA FUNKCIJA

Automatsko uključivanje/isključivanje osigurava dulji radni vijek učinkovitim korištenjem baterije

ZAŠTITA OD RADA NA SUHO

Pumpa se automatski isključuje čim više nema vode na usisnoj strani, čime se štiti od oštećenja

AKU AUTOMATSKA VRTNA PUMPA



	AQUINNA 36/38 F LED AUTOMATIC	NOVO
	EXPERT	
PXC baterija napon / kapacitet	2x 18 V / -	
Maks. dostavni kapacitet / visina	3800 l/h / 37 m	
Maks. usisna snaga	6 m	
Usisni priključak	33,3 mm (1") VN	
Tlačni priključak	33,3 mm (1") UN	
Težina proizvoda	4,8 kg	
Vijak za ulijevanje vode	•	
Vijak za ispuštanje vode	•	
Prekidač razine snage (ECO / BOOST)	•	
Indikator kapaciteta baterije (LED)	•	
Predfilter	•	
Nepovratni ventil	•	
Indikator punjenja vodom / prljavštine	• / •	
Indikator usisavanja	•	
Automatska funkcija	•	
Zaštita od rada na suho	•	
Broj baterija / punjača	0 / 0	
Pribor	-	
Broj artikla	41.804.20	



4 006825 668391

AKUMULATORSKE
VRTNE PUMPE

	AQUINNA 36/38 F LED EXPERT NOVO	AQUINNA 36/30 EXPERT
PXC baterija napon / kapacitet	2x 18 V / -	2x 18 V / -
Maks. dostavni kapacitet / visina	3800 l/h / 37 m	3000 l/h / 26 m
Maks. usisna snaga	6 m	8 m
Usisni priključak	33,3 mm (1") VN	42 mm (1¼") VN
Tlačni priključak	33,3 mm (1") UN	33,3 mm (1") UN
Težina proizvoda	4,3 kg	3,3 kg
Vijak za ulijevanje vode	•	•
Vijak za ispuštanje vode	•	•
Prekidač razine snage (ECO / BOOST)	•	•
Indikator kapaciteta baterije (LED)	•	-
Predfilter	•	-
Nepovratni ventil	•	-
Indikator punjenja vodom / prljavštine	• / •	- / -
Indikator usisavanja	-	-
Automatska funkcija	-	-
Zaštita od rada na suho	-	-
Broj baterija / punjača	0 / 0	0 / 0
Pribor	-	Adapter 33,3 mm (1") VN
Broj artikla	41.804.10	41.804.00



4 006825 668384



4 006825 638981

AKUMULATORSKE
VRTNE PUMPE

	AQUINNA 18/30 F LED EXPERT NOVO	AQUINNA 18/28 EXPERT NOVO
PXC baterija napon / kapacitet	18 V (+ 18 V) / -	18 V / -
Maks. dostavni kapacitet / visina	3000 l/h / 28 m	2800 l/h / 25 m
Maks. usisna snaga	6 m	6 m
Usisni priključak	33,3 mm (1") VN	33,3 mm (1") VN
Tlačni priključak	33,3 mm (1") UN	33,3 mm (1") UN
Težina proizvoda	3,9 kg	2,4 kg
Vijak za ulijevanje vode	•	•
Vijak za ispuštanje vode	•	•
Prekidač razine snage (ECO / BOOST)	•	•
Indikator kapaciteta baterije (LED)	•	-
Predfilter	•	-
Nepovratni ventil	•	-
Indikator punjenja vodom / prljavštine	• / •	- / -
Indikator usisavanja	-	-
Automatska funkcija	-	-
Zaštita od rada na suho	-	-
Broj baterija / punjača	0 / 0	0 / 0
Broj artikla	41.804.30	41.804.40



4 006825 668513



4 006825 668711

AKU POTOPNA PUMPA ZA ČISTU VODU



PRIKLJUČNA CIJEV

Beskonačno podesiva teleskopska cijev s praktičnim držačem i fleksibilnim priključkom cijeva za individualno pozicioniranje vrtnog crijeva

DUGAČKI KABEL

Za veću dubinu uranjanja

SNAŽAN MOTOR

Stvara visoki tlak isporuke od preko 2 bara, što omogućuje jednostavno rukovanje prskalicom za travnjak i vrtnim pištoljem za prskanje

STABILNO KUĆIŠTE

Visokokvalitetno kućište pumpe izrađeno od plastike otporne na udarce

2U1 PUMPA

Dugi kabelski priključak znači da se GE-PP 18 RB Li može koristiti kao **potopna tlačna pumpa**, npr. u cisterni, a s podesivom priključnom cijevi kao **pumpa za kišnicu**

RAD POMOĆU BATERIJE

Navodnjavanje vrta bez utičnice - samostalno i snažno

KUTIJA ZA BATERIJU

Mobilna s integriranim držačem za pohranu kabela i raznim mogućnostima pričvršćivanja



Aku potopna pumpa za čistu vodu
GE-PP 18 RB Li

AKU POTOPNA PUMPA ZA ČISTU VODU



	GE-PP 18 RB Li - Solo EXPERT
PXC baterija napon / kapacitet	18 V / -
Maks. dostavni kapacitet / visina	3000 l/h / 20 m
Maks. dubina uranjanja	4 m
Priključak crijeva	33,3 mm (1") VN
Duljina kabela	5 m
Težina proizvoda bez / s priborom	2,5 / 2,8 kg
Mobilna kutija za bateriju	•
Integrirana pohrana kabela	•
Integrirani nosač za montažu na zid	•
Nosač za vješanje od nehrđajućeg čelika	•
Teleskopska priključna cijev	•
Fleksibilni vrat priključne cijevi	•
Broj baterija / punjača	0 / 0
Broj artikla	41.704.29



4 006825 651270

AKU POTOPNA PUMPA ZA ČISTU VODU



GE-SP 18 LL Li - Solo

EXPERT

PXC baterija napon / kapacitet	18 V / -
Maks. dostavni kapacitet / visina	4500 l/h / 8 m
Maks. dubina uranjanja	4 m
Priključak crijeva	33,3 mm (1") VN
Duljina kabela	5 m
Težina proizvoda bez / s priborom	2,2 / 2,3 kg
Mobilna kutija za bateriju	•
Zaštita od rada na suho	•
Integrirana pohrana kabela	•
Integrirani nosač za montažu na zid	•
Nosač za vješanje od nehrđajućeg čelika	•
Teleskopska priključna cijev	-
Fleksibilni vrat priključne cijevi	-
Niska razina usisavanja vode sve do 1 mm	•
Broj baterija / punjača	0 / 0
Broj artikla	41.815.60



4 006825 661415

AKU POTOPNA PUMPA ZA ČISTU VODU



GE-SP 18 Li - Solo

EXPERT

PXC baterija napon / kapacitet	18 V / -
Maks. dostavni kapacitet / visina	5000 l/h / 8 m
Maks. dubina uranjanja	4 m
Usisavanje vode do razine od	15 mm
Priključak crijeva	33,3 mm (1") VN
Duljina kabela	5 m
Težina proizvoda bez / s priborom	2,6 / 2,7 kg
Mobilna kutija za bateriju	•
Zaštita od rada na suho	•
Integrirana pohrana kabela	•
Integrirani nosač za montažu na zid	•
Nosač za vješanje od nehrđajućeg čelika	•
Teleskopska priključna cijev	-
Fleksibilni vrat priključne cijevi	-
Broj baterija / punjača	0 / 0
Broj artikla	41.815.00



4 006825 651379

AKU POTOPNA PUMPA ZA NEČISTU VODU

RAD POMOĆU BATERIJE

Navodnjavanje vrta bez utičnice - samostalno i snažno

STABILNO KUČIŠTE

Visokokvalitetno kučište pumpe izrađeno od plastike otporne na udarce

SNAŽAN MOTOR

Za maksimalni protok do 7500 l/h

VELIČINA STRANIH ČESTICA DO 25 MM

PREKIDAČ RAZINE SNAGE

ECO i BOOST način rada



Aku potopna pumpa za nečistu vodu
GE-DP 18/25 Li

MOBILNA KUTIJA ZA BATERIJU

S integriranom pohranom za kabel

DUGAČKI KABEL

Za veću dubinu uranjanja

AKU POTOPNA PUMPA ZA NEČISTU VODU



	GE-DP 18/25 Li - Solo	NOVO
	EXPERT	
PXC baterija napon / kapacitet	18 V / -	
Maks. dostavni kapacitet / visina	7500 l/h / 5 m	
Maks. dubina uranjanja	4 m	
Usisavanje vode do razine od	35 mm	
Veličina stranih čestica do	25 mm	
Priključak crijeva	33,3 mm (1") VN	
Duljina kabla	5 m	
Težina proizvoda bez / s priborom	3,3 / 3,4 Kg	
Mobilna kutija za bateriju	•	
Zaštita od rada na suho	•	
Integrirana pohrana kabela	•	
Integrirani nosač za montažu na zid	•	
Nosač za vješanje od nehrđajućeg čelika	•	
Niska razina usisavanja vode sve do 1 mm	-	
Odabir razine snage: ECO i BOOST	•	
Regulacija razine usisavanja	-	
Broj baterija / punjača	0 / 0	
Adapter za univerzalno crijevo	•	
Broj artikla	41.815.80	



4 006825 665642

AKU POTOPNA PUMPA ZA NEČISTU VODU



GE-DP 18/25 LL Li - Solo

EXPERT
NOVO



































PXC baterija napon / kapacitet	18 V / -
Maks. dostavni kapacitet / visina	7000 l/h / 5 m
Maks. dubina uranjanja	4 m
Usisavanje vode do razine od	1 mm
Veličina stranih čestica do	25 mm
Priključak crijeva	42 mm (1½") VN
Duljina kabela	5 m
Težina proizvoda bez / s priborom	3,4 / 3,5 kg
Mobilna kutija za bateriju	•
Zaštita od rada na suho	•
Integrirana pohrana kabela	•
Integrirani nosač za montažu na zid	•
Nosač za vješanje od nehrđajućeg čelika	•
Niska razina usisavanja vode sve do 1 mm	•
Odabir razina snage: ECO i BOOST	•
Regulacija razine usisavanja	•
Broj baterija / punjača	0 / 0
Adapter za univerzalno crijevo	•
Broj artikla	41.815.90



4 006825 668780



VODIČ ZA BATERIJE – VRIJEME RADA S BATERIJOM

									
			18 V 2,0 Ah	18 V 2,5 Ah	18 V 3,0 Ah	18 V 4,0 Ah	18 V 5,2 Ah	18 V 6,0 Ah	18 V 8,0 Ah
Benzinske kosilice (PXC elektro start)	GC-PM 51/3 S HW-E Li		174 paljenja	218 paljenja	261 paljenja	347 paljenja	452 paljenja	522 paljenja	695 paljenja
	GC-PM 46 SM HW-E Li		193 paljenja	242 paljenja	290 paljenja	386 paljenja	502 paljenja	580 paljenja	772 paljenja
Akumulatorske kosilice	RASARRO 36/42		300 m ²	350 m ²	450 m ²	550 m ²	725 m ²	875 m ²	1100 m ²
	RASARRO 36/40		280 m ²	330 m ²	425 m ²	500 m ²	700 m ²	850 m ²	1000 m ²
	RASARRO 36/38		300 m ²	330 m ²	400 m ²	450 m ²	700 m ²	800 m ²	900 m ²
	RASARRO 36/36		250 m ²	290 m ²	400 m ²	450 m ²	650 m ²	800 m ²	900 m ²
	RASARRO 36/34		200 m ²	250 m ²	300 m ²	400 m ²	500 m ²	600 m ²	800 m ²
	GP-CM 36/47 S HW Li		175 m ² 350 m ²	215 m ² 430 m ²	250 m ² 500 m ²	350 m ² 700 m ²	500 m ² 1000 m ²	600 m ² 1200 m ²	700 m ² 1400 m ²
	GE-CM 36/48 Li M		250 m ² 500 m ²	260 m ² 520 m ²	300 m ² 600 m ²	500 m ² 1000 m ²	600 m ² 1200 m ²	700 m ² 1400 m ²	1000 m ² 2000 m ²
	GE-CM 36/43 Li M		300 m ²	350 m ²	450 m ²	600 m ²	750 m ²	900 m ²	1200 m ²
	GP-CM 36/41 Li		280 m ²	330 m ²	425 m ²	500 m ²	700 m ²	850 m ²	1000 m ²
	GE-CM 36/37 Li		250 m ²	290 m ²	400 m ²	450 m ²	650 m ²	800 m ²	900 m ²
	GE-CM 36/36 Li		240 m ²	270 m ²	350 m ²	400 m ²	600 m ²	700 m ²	960 m ²
	GE-CM 36/34-1 Li		200 m ²	250 m ²	300 m ²	400 m ²	500 m ²	600 m ²	800 m ²
	GE-CM 36/33 Li		200 m ²	250 m ²	300 m ²	400 m ²	500 m ²	600 m ²	800 m ²
	GE-CM 18/33 Li		100 m ²	140 m ²	180 m ²	250 m ²	300 m ²	350 m ²	500 m ²
	GE-CM 18/32 Li		100 m ²	140 m ²	180 m ²	250 m ²	300 m ²	350 m ²	500 m ²
	GE-CM 18/30 Li		70 m ²	100 m ²	150 m ²	210 m ²	270 m ²	300 m ²	420 m ²
	Akumulatorska ručna kosilica	GE-HM 18/38 Li		150 m ²	190 m ²	250 m ²	300 m ²	400 m ²	450 m ²
Aku univerzalni uređaj za sijanje	GE-US 18 Li		3 h	4 h	6 h	7 h	9 h	10 h	14 h
Akumulatorski prozračivači trave	GE-SC 36/35 Li		150 m ²	190 m ²	225 m ²	300 m ²	400 m ²	450 m ²	550 m ²
	GE-SA 36/35 Li		150 m ²	190 m ²	225 m ²	300 m ²	400 m ²	450 m ²	550 m ²
	GC-SC 36/31 Li		100 m ²	130 m ²	200 m ²	250 m ²	300 m ²	350 m ²	500 m ²
	GC-SC 18/28 Li		80 m ²	100 m ²	120 m ²	160 m ²	210 m ²	240 m ²	350 m ²
Akumulatorska bušilica za zemlju	GP-EA 18/150 Li Brushless		15 kom	20 kom	30 kom	40 kom	50 kom	60 kom	80 kom
Akumulatorski čistač snijega	GE-ST 36/40 Li E		20 min	25 min	30 min	40 min	50 min	60 min	80 min
Akumulatorske kopačice	GE-CR 30 Li		20 min	21 min	25 min	35 min	50 min	60 min	70 min
	GE-CR 18/20 Li E		25-35 min	30-40 min	40-50 min	50-70 min	70-90 min	80-100 min	100-140 min



































VODIČ ZA BATERIJE – VRIJEME RADA S BATERIJOM



















18 V 2,0 Ah 18 V 2,5 Ah 18 V 3,0 Ah 18 V 4,0 Ah 18 V 5,2 Ah 18 V 6,0 Ah 18 V 8,0 Ah

			18 V 2,0 Ah	18 V 2,5 Ah	18 V 3,0 Ah	18 V 4,0 Ah	18 V 5,2 Ah	18 V 6,0 Ah	18 V 8,0 Ah
Akumulatorski trimeri za travu (rezná nit + nož)	AGILLO 36/255		30 min 25 min	35 min 28 min	45 min 35 min	65 min 45 min	80 min 60 min	90 min 70 min	130 min 90 min
	AGILLO 18/200		20 min 12 min	25 min 15 min	35 min 20 min	50 min 30 min	65 min 45 min	75 min 55 min	100 min 60 min
Akumulatorski trimeri za travu	GE-CT 36/30 Li E		30 min	38 min	45 min	60 min	75 min	90 min	120 min
	GE-CT 18/30 Li		30 min	38 min	45 min	60 min	75 min	90 min	120 min
	GE-CT 18/28 Li TC		45 min	55 min	70 min	85 min	95 min	115 min	120 min
	GE-CT 18/28 Li		45 min	55 min	70 min	85 min	95 min	115 min	120 min
	GE-CT 18 Li		55 min	65 min	80 min	125 min	160 min	180 min	250 min
	GC-CT 18/24 Li		55 min	65 min	80 min	125 min	160 min	180 min	250 min
	GC-CT 18/24 Li P		55 min	65 min	80 min	125 min	160 min	180 min	250 min
Akumulatorski trimmer za rubove travnjaka	GE-LE 18/190 Li		25 min	33 min	45 min	55 min	65 min	75 min	110 min
Akumulatorski uređaj za čišćenje fuga	GC-CC 18 Li		45 min	50 min	60 min	90 min	120 min	135 min	180 min
Akumulatorski uređaj za čišćenje terasa	PICOBELLA		10-30 min	12-34 min	17-46 min	20-55 min	25-70 min	29-90 min	40-110 min
Akumulatorske škare za živicu	GE-CH 36/65 Li		75 min	93 min	120 min	150 min	180 min	225 min	300 min
	GE-CH 36/61 Li		72 min	80 min	105 min	144 min	168 min	210 min	288 min
	GE-CH 18/60 Li		45 min	53 min	70 min	90 min	110 min	135 min	180 min
	ARCURRA 18/55		45 min	53 min	70 min	90 min	110 min	135 min	180 min
	GC-CH 1855/1 Li		80 min	100 min	120 min	160 min	210 min	240 min	320 min
	GC-CH 18/50 Li		53 min	67 min	80 min	106 min	139 min	160 min	212 min
	GC-CH 1846 Li		80 min	100 min	120 min	160 min	210 min	240 min	320 min
	GC-CH 18/40 Li		53 min	67 min	80 min	106 min	139 min	160 min	212 min
Akumulatorski tresač maslina i plodova	GE-FS 18/53 Li		25 min	32 min	38 min	50 min	65 min	76 min	100 min
Akumulatorski višenamjenski vrtni alati	GE-LM 36/4in1		34 min	41 min	54 min	68 min	86 min	108 min	136 min
			27 min	33 min	44 min	54 min	66 min	88 min	108 min
			28 min	33 min	40 min	56 min	66 min	80 min	112 min
			80 kom	100 kom	120 kom	160 kom	200 kom	240 kom	320 kom
	GE-HC 18 Li T		40 kom	48 kom	60 kom	75 kom	100 kom	120 kom	150 kom
			30 min	35 min	40 min	60 min	75 min	80 min	120 min
Akumulatorske teleskopske lančane pile	GE-LC 18 Li T		40 kom	48 kom	60 kom	75 kom	100 kom	120 kom	150 kom
	GC-LC 18/20 Li T		50 kom	65 kom	75 kom	100 kom	130 kom	135 kom	200 kom

VODIČ ZA BATERIJE - VRIJEME RADA S BATERIJOM

									
			18 V 2,0 Ah	18 V 2,5 Ah	18 V 3,0 Ah	18 V 4,0 Ah	18 V 5,2 Ah	18 V 6,0 Ah	18 V 8,0 Ah
Akumulatorske teleskopske škare za živicu	GE-HH 18/45 Li T		30 min	35 min	40 min	60 min	75 min	80 min	120 min
	GC-HH 18/45 Li T		28 min	33 min	40 min	56 min	66 min	80 min	112 min
Akumulatorske lančane pile	FORTEXXA 18/20 TH		80 kom	100 kom	120 kom	160 kom	208 kom	240 kom	320 kom
	GP-LC 36/35 Li		160 kom	200 kom	240 kom	320 kom	420 kom	480 kom	640 kom
	FORTEXXA 18/30	 Eco High	78 kom 70 kom	98 kom 88 kom	117 kom 105 kom	156 kom 140 kom	203 kom 182 kom	234 kom 210 kom	280 kom 312 kom
	GE-LC 18/25 Li		70 kom	85 kom	100 kom	130 kom	180 kom	200 kom	260 kom
Akumulatorski oštrač lanaca	GE-CS 18 Li		240 min	300 min	390 min	480 min	660 min	780 min	960 min
Akumulatorski puhači lišća	GP-LB 36/210 Li E		10-55 min	11-63 min	16-92 min	20-116 min	26-138 min	30-165 min	40-232 min
	GP-LB 18/200 Li GK		5-13 min	8-15 min	10-21 min	15-27 min	18-33 min	20-37 min	30-54 min
	GP-LB 18/200 Li E		5-13 min	8-15 min	10-21 min	15-27 min	18-33 min	20-37 min	30-54 min
	GC-CL 18 Li E		14-240 min	16-300 min	20-390 min	26-480 min	40-660 min	42-720 min	52-960 min
Akumulatorski univerzalni puhač	GE-UB 18/250 Li E		10-65 min	12-80 min	14-96 min	20-130 min	24-166 min	28-192 min	40-260 min
Akumulatorski usisavači/puhači lišća	VENTURRO 36/240	 usisavač puhač	9-23 min 9-25 min	10-27 min 10-28 min	14-35 min 14-37 min	17-46 min 18-49 min	21-56 min 21-58 min	27-70 min 28-74 min	34-92 min 36-98 min
	GE-CL 36 Li E	 usisavač puhač	10-30 min 13-35 min	13-35 min 16-40 min	17-45 min 21-60 min	22-65 min 27-75 min	27-90 min 32-105 min	30-100 min 39-120 min	44-130 min 54-150 min
	GE-CL 36/230 Li E	 usisavač puhač	12-28 min 13-29 min	14-34 min 16-35 min	20-45 min 24-50 min	24-55 min 27-58 min	30-75 min 37-79 min	35-85 min 43-91 min	48-110 min 54-116 min
	VENTURRO 18/210	 usisavač puhač	0-14 min 4-15 min	5-18 min 5-19 min	7-20 min 7-22 min	9-30 min 9-32 min	11-42 min 13-40 min	15-45 min 14-48 min	18-60 min 18-64 min
Akumulatorske škare za travu i grmlje	GE-CG 18/100 Li T		240 min	300 min	360 min	480 min	650 min	720 min	960 min
	GE-CG 18/100 Li		240 min	300 min	360 min	480 min	650 min	720 min	960 min
	GC-CG 18 Li		240 min	300 min	360 min	480 min	650 min	720 min	960 min
	GC-CG 18/1 Li		240 min	300 min	360 min	480 min	650 min	720 min	960 min
Akumulatorska pila za grane	GE-GS 18/150 Li		90 kom	115 kom	140 kom	180 kom	240 kom	280 kom	360 kom
Akumulatorske škare za obrezivanje	GE-LS 18 Li		1426 kom	1783 kom	2139 kom	2852 kom	3708 kom	4278 kom	5704 kom
Akumulatorske tlačne prskalice	GE-WS 18/150 Li		2,5 h	3,5 h	4 h	5 h	7 h	8,5 h	10 h
	GE-WS 18/75 Li		6 h	7,5 h	10 h	12 h	16 h	20 h	24 h
	GE-WS 18/35 Li		6 h	7,5 h	10 h	12 h	16 h	20 h	24 h
	GE-WS 18/10 Li		16 h	20 h	24 h	32 h	42 h	48 h	64 h
Akumulatorski ventilator	GE-CF 18/2200 Li	 min. brzina maks. brzina	7,0 h 2,6 h	8,8 h 3,3 h	10,6 h 4,0 h	14,0 h 5,6 h	18,3 h 7,0 h	21,2 h 8,0 h	28,0 h 11,2 h
Akumulatorski plinski grijač	GE-HG 18/370 Niro Li		140 min	160 min	180 min	280 min	330 min	380 min	560 min

VODIČ ZA BATERIJE – VRIJEME RADA S BATERIJOM









									
			18 V 2,0 Ah	18 V 2,5 Ah	18 V 3,0 Ah	18 V 4,0 Ah	18 V 5,2 Ah	18 V 6,0 Ah	18 V 8,0 Ah
Aku automatska vrtna pumpa	AQUINNA 36/38 F LED AUTOMATIC	 BOOST ECO	16 min 32 min	20 min 40 min	24 min 48 min	32 min 64 min	42 min 84 min	48 min 96 min	64 min 128 min
Akumulatorske vrtno pumpe	AQUINNA 36/38 F LED	 BOOST ECO	16 min 32 min	20 min 40 min	24 min 48 min	32 min 64 min	42 min 84 min	48 min 96 min	64 min 128 min
	AQUINNA 36/30	 BOOST ECO	15 min 35 min	23 min 47 min	30 min 55 min	35 min 70 min	45 min 85 min	50 min 100 min	70 min 140 min
	AQUINNA 18/30 F LED	 BOOST ECO	15 min 19 min	17 min 23 min	20 min 28 min	30 min 38 min	36 min 48 min	40 min 56 min	60 min 76 min
	AQUINNA 18/28	 BOOST ECO	14 min 18 min	17 min 22 min	20 min 27 min	28 min 36 min	36 min 47 min	40 min 54 min	56 min 72 min
Akumulatorske potopne pumpe za čistu vodu	GE-PP 18 RB Li		15 min	20 min	25 min	30 min	35 min	45 min	60 min
	GE-SP 18 LL Li		30 min	35 min	40 min	60 min	70 min	80 min	120 min
	GE-SP 18 Li		30 min	35 min	40 min	60 min	70 min	80 min	120 min
Akumulatorske potopne pumpe za nečistu vodu	GE-DP 18/25 Li	 BOOST ECO	15 min 21 min	19 min 26 min	23 min 32 min	30 min 42 min	40 min 55 min	46 min 64 min	60 min 84 min
	GE-DP 18/25 LL Li	 BOOST ECO	15 min 21 min	19 min 26 min	23 min 32 min	30 min 42 min	40 min 55 min	46 min 64 min	60 min 84 min



70 kom

OSNOVNA IZVEDBA – Preporučuje se nadogradnja

Vrijednosti u svjetlijim poljima (npr. vidi gore) pokazuju da se preporučuje korištenje baterije veće snage/kapaciteta za punu snagu i razumno vrijeme rada uređaja.

Objašnjenje simbola:

-  Maks. broj paljenja po punjenju baterije
-  Maks. površina koja se obrađuje po punjenju baterije
-  Maks. površina koja se obrađuje po punjenju baterije s 2 ili 4 baterije (kod GP-CM 36/47 S HW Li mogu se koristiti 2 ili 4 baterije!)
-  Maks. vrijeme rada u praznom hodu po punjenju baterije
-  Maks. broj rupa (40 cm dubine, mješovito tlo) po punjenju baterije
-  Maks. vrijeme rada u praznom hodu po punjenju baterije (s nožem)
-  Maks. vrijeme rada u praznom hodu po punjenju baterije (s reznom nit)
-  Maks. vrijeme rada u praznom hodu po punjenju baterije (sa škarama za živicu)
-  Maks. broj rezova po punjenju baterije kroz pravougaono drvo 70 x 70 mm

-  Maks. broj rezova po punjenju baterije kroz oblo drvo ø 60 mm
-  Maks. broj rezova kroz suho bukovo drvo ø 15 mm po punjenju baterije

Usisavač / puhač:
Vrijeme rada kada se koristi funkcija puhanja ili usisavanja
BOOST / ECO: Vrijeme rada u Boost ili Eco načinu rada

Sve navedene vrijednosti su maksimalne vrijednosti i određene su pod standardiziranim uvjetima ispitivanja. Vrijednosti u svakodnevnoj uporabi mogu odstupati od toga.

ELEKTRIČNI RUČNI ALATI



AKUMULATORSKI ODVIJAČI 3,6 V

**3.6 V
POWER**

	TE-SD 3,6/1 Li EXPERT	TE-SD 3,6 Li Kit EXPERT	TC-SD 3,6 Li CLASSIC
Li-Ion baterija napon / kapacitet	3,6 V / 1,5 Ah	3,6 V / 1,5 Ah	3,6 V / 1,3 Ah
Vrijeme punjenja	3 - 5 h	3 h	3 - 5 h
Broj okretaja	180 min ⁻¹	200 min ⁻¹	200 min ⁻¹
Zakretni moment (tvrdo)	4,5 Nm	3,5 Nm	3 Nm
Težina proizvoda	0,4 kg	0,4 kg	0,4 kg
Sigurnosni rukavac bitova	-	•	-
Okretna ručka	-	•	•
LED svjetlo	•	•	•
Micro USB punjač	•	-	-
Okretanje lijevo / desno	•	•	•
Indikator stanja napunjenosti	-	•	•
Magnetni prihvat vijaka	-	•	-
Pribor	10 bitova	32-dijelna kutija za bitove	6 bitova
Punjač	-	-	-
Pakiranje	Limena kutija	Limena kutija	Karton
Broj artikla	45.135.01	45.134.95	45.134.42



4 006825 622744



4 006825 598575



4 006825 604733

AKUMULATORSKA BUŠILICA 12 V

**REMOVABLE
DRILL
CHUCK**

	TE-CD 12/1 X-Li (1x 2,0 Ah) EXPERT
Li-Ion baterija napon / kapacitet	12 V / 2,0 Ah
Vrijeme punjenja	45 min
Broj okretaja	0 - 400 / 0 - 1400 min ⁻¹
Zakretni moment (tvrdo)	30 Nm
Postavke zakretnih momenata	19+1
Stezna glava	10 mm
Težina proizvoda	1,1 kg (s baterijom)
Broj uklonjivih dodataka	1
Metalni prijenos	•
Brzo zaustavljanje	•
LED svjetlo	•
Odvojiva stezna glava	•
Broj baterija / punjača	1 / 1x 45 min punjač
Pribor	-
Pakiranje	Karton
Broj artikla	45.135.92



4 006825 628685

AKUMULATORSKE BUŠILICE 12 V

**30 Nm
HIGH
POWER**



	TE-CD 12/1 Li (1x 2,0 Ah) EXPERT	TE-CD 12/1 Li (2x 2,0 Ah) EXPERT
Li-Ion baterija napon / kapacitet	12 V / 2,0 Ah	12 V / 2,0 Ah
Vrijeme punjenja	45 min	45 min
Broj okretaja	0 - 400 / 0 - 1400 min ⁻¹	0 - 400 / 0 - 1400 min ⁻¹
Zakretni moment (tvrdo)	30 Nm	30 Nm
Postavke zakretnih momenata	19+1	19+1
Stezna glava	10 mm	10 mm
Težina proizvoda	1,1 kg (s baterijom)	1,1 kg (s baterijom)
Broj uklonjivih dodataka	-	-
Metalni prijenos	•	•
Brzo zaustavljanje	•	•
LED svjetlo	•	•
Odvojiva stezna glava	-	-
Broj baterija / punjača	1 / 1x 45 min punjač	2 / 1x 45 min punjač
Pribor	5 bitova	5 bitova
Pakiranje	Karton	Karton
Broj artikla	45.135.90	45.135.94



AKUMULATORSKE BUŠILICE 12 V

**DRILL+
SCREW**



	TH-CD 12-2 Li CLASSIC	TC-CD 12-2 Li +22 CLASSIC NOVO
Li-Ion baterija napon / kapacitet	12 V / 1,3 Ah	12 V / 1,5 Ah
Vrijeme punjenja	3 - 5 h	3 - 5 h
Broj okretaja	0 - 350 / 0 - 1300 min ⁻¹	0 - 350 / 0 - 1300 min ⁻¹
Zakretni moment (tvrdo)	24 Nm	24 Nm
Postavke zakretnih momenata	19+1	19+1
Stezna glava	10 mm	10 mm
Težina proizvoda	1,0 kg (s baterijom)	1,0 kg (s baterijom)
Broj uklonjivih dodataka	-	-
Metalni prijenos	•	•
Brzo zaustavljanje	•	•
LED svjetlo	-	-
Odvojiva stezna glava	-	-
Broj baterija / punjača	1 / 1x 3-5 h punjač	1 / 1x 3-5 h punjač
Pribor	-	22-dijelna kutija za bitove, 200-dijelna kutija za vijke
Pakiranje	Karton	Karton
Broj artikla	45.136.60	45.142.50



AKUMULATORSKA UDARNA BUŠILICA 12 V

TE-CD 12/1 Li-i (2x 2,0 Ah)
EXPERT

Li-Ion baterija napon / kapacitet	12 V / 2,0 Ah
Vrijeme punjenja	45 min
Broj okretaja	0 - 400 / 0 - 1400 min ⁻¹
Broj udaraca	0 - 6000 / 0 - 21000 min ⁻¹
Zakretni moment (tvrdo)	30 Nm
Postavke zakretnih momenata	20+1+1
Stezna glava	10 mm
Težina proizvoda	1,2 kg (s baterijom)
Metalni prijenos	•
Brzo zaustavljanje	•
LED svjetlo	•
Odvojiva stezna glava	-
Okretanje lijevo / desno	•
Broj baterija / punjača	2 / 1x 45 min punjač
Dodatna ručka	-
Pakiranje	Karton
Broj artikla	45.138.90



ODVIJAČ ZA KNAUF



**AUTO-
START-
STOP**

	TC-DY 710 E CLASSIC NOVO
Napon	220 - 240 V ~ 50 Hz
Snaga	710 W
Broj okretaja	0 - 4000 min ⁻¹
Prihvatale	Unutarnji šesterokutni 6,35 mm (1/4")
Težina proizvoda	1,5 kg
Aluminijska glava prijenosa	•
Podesiva dubina uvrtnja	•
Automatski start / stop prijenos	•
Kopča za remen	•
Prekidač za konstantni rad	•
Elektronska kontrola brzine	•
Pakiranje	Karton
Broj artikla	42.599.25



4 006825 666991

UDARNE BUŠILICE

2 FUNCTIONS



	TC-ID 1000 E CLASSIC	TC-ID 1000 E Kit CLASSIC	TE-ID 650 E EXPERT
Napon	230 V ~ 50 Hz	230 - 240 V ~ 50 Hz	220 - 240 V ~ 50 Hz
Snaga	1010 W	1010 W	650 W
Broj okretaja	0 - 3000 min ⁻¹	0 - 3000 min ⁻¹	0 - 3000 min ⁻¹
Broj udaraca	0 - 48000 min ⁻¹	0 - 48000 min ⁻¹	0 - 48000 min ⁻¹
Kapacitet bušenja drvo	32 mm	32 mm	25 mm
Kapacitet bušenja beton	16 mm	16 mm	13 mm
Kapacitet bušenja čelik	13 mm	13 mm	10 mm
Stezna glava	13 mm	13 mm	13 mm
Težina proizvoda	2,1 kg	2,0 kg	2,1 kg
Elektronska kontrola brzine	•	•	•
Blokada osovine	-	-	•
Mekani rukohvat	•	•	•
Metalna stezna glava	•	-	•
Dodatna ručka	•	•	•
Pribor	-	16-dijelni set svrdla	-
Pakiranje	Karton	Tasche	Karton
Broj artikla	42.598.25	42.598.44	42.597.35



4 006825 587777



4 006825 635003



4 006825 565690

UDARNE BUŠILICE



	TC-ID 720/1 E CLASSIC	TC-ID 650 E CLASSIC
Napon	220 - 240 V ~ 50-60 Hz	230 V ~ 50 Hz
Snaga	720 W	650 W
Broj okretaja	0 - 2800 min ⁻¹	0 - 2600 min ⁻¹
Broj udaraca	0 - 44800 min ⁻¹	0 - 41600 min ⁻¹
Kapacitet bušenja drvo	30 mm	25 mm
Kapacitet bušenja beton	13 mm	13 mm
Kapacitet bušenja čelik	10 mm	10 mm
Stezna glava	13 mm	13 mm
Težina proizvoda	2,0 kg	1,8 kg
Elektronska kontrola brzine	•	•
Blokada osovine	-	-
Mekani rukohvat	•	-
Metalna stezna glava	-	-
Dodatna ručka	•	•
Pribor	-	-
Pakiranje	Karton	Karton
Broj artikla	42.598.48	42.586.82



4 006825 641844



4 006825 602166

UDARNE BUŠILICE



	TE-ID 500 E EXPERT	TC-ID 550 E CLASSIC
Napon	220 - 240 V ~ 50/60 Hz	220 - 240 V ~ 50/60 Hz
Snaga	550 W	550 W
Broj okretaja	0 - 3000 min ⁻¹	0 - 2800 min ⁻¹
Broj udaraca	0 - 48000 min ⁻¹	0 - 44800 min ⁻¹
Kapacitet bušenja drvo	25 mm	25 mm
Kapacitet bušenja beton	10 mm	13 mm
Kapacitet bušenja čelik	8 mm	10 mm
Stezna glava	13 mm	13 mm
Težina proizvoda	1,7 kg	1,7 kg
Elektronska kontrola brzine	•	•
Blokada osovine	-	-
Mekani rukohvat	•	•
Metalna stezna glava	-	-
Dodatna ručka	•	•
Pribor	5-dijelni set svrdla	-
Pakiranje	Karton	Karton
Broj artikla	42.596.10	42.586.21



4 006825 591347



4 006825 616712

ČEKIĆ BUŠILICA 2 KG



	TE-RH 950 5F EXPERT
Napon	220 - 240 V ~ 50 Hz
Snaga	950 W
Broj okretaja	0 - 1200 / 0 - 2600 min ⁻¹
Broj udaraca	0 - 4500 min ⁻¹
Snaga udarca	3,0 J
Kapacitet bušenja beton	28 mm
Stezna glava	SDS-plus
Težina proizvoda	3,8 kg
Elektronska kontrola brzine	•
Anti-vibracijska ručka	-
Klizna spojka za veću sigurnost pri radu	•
Pneumatski udarni mehanizam	•
Funkcije	5
Zaključavanje za konstantni rad	•
Dodatna ručka	•
Metalni graničnik dubine	•
Pribor	Stezna glava bez ključa
Pakiranje	E-Box Basic
Broj artikla	42.579.78



ČEKIĆ BUŠILICE 2 KG



	TC-RH 800 4F CLASSIC
Napon	220 - 240 V ~ 50 Hz
Snaga	800 W
Broj okretaja	0 - 930 min ⁻¹
Broj udaraca	0 - 4500 min ⁻¹
Snaga udarca	2,6 J
Kapacitet bušenja beton	26 mm
Stezna glava	SDS-plus
Težina proizvoda	3,2 kg
Elektronska kontrola brzine	•
Anti-vibracijska ručka	-
Klizna spojka za veću sigurnost pri radu	•
Pneumatski udarni mehanizam	•
Funkcije	4
Zaključavanje za konstantni rad	•
Dodatna ručka	•
Metalni graničnik dubine	•
Pribor	-
Pakiranje	E-Box Basic
Broj artikla	42.579.80

	TC-RH 620 4F CLASSIC
Napon	230 - 240 V ~ 50 Hz
Snaga	620 W
Broj okretaja	0 - 1250 min ⁻¹
Broj udaraca	0 - 5200 min ⁻¹
Snaga udarca	2,2 J
Kapacitet bušenja beton	20 mm
Stezna glava	SDS-plus
Težina proizvoda	2,8 kg
Elektronska kontrola brzine	•
Anti-vibracijska ručka	-
Klizna spojka za veću sigurnost pri radu	•
Pneumatski udarni mehanizam	•
Funkcije	4
Zaključavanje za konstantni rad	•
Dodatna ručka	•
Metalni graničnik dubine	•
Pribor	-
Pakiranje	E-Box Basic
Broj artikla	42.579.90



ČEKIĆ BUŠILICE 5 KG

SDS-MAX STEZNA GLAVA

SDS-max stezna glava s poluautomatskom funkcijom izuzetno je robustna i pogodna za zahtjevnu upotrebu

3 FUNKCIJE

Tri osnovne funkcije u jednom uređaju: udarno bušenje i klesanje sa i bez fiksacije dlijeta. Praktično: jedan prekidač za sve funkcije

ANTIVIBRACIJSKA RUČKA

Ručka čekić bušilice osigurava rad s minimalnim vibracijama

ZAKLJUČAVANJE ZA KONSTANTNI RAD

Čekić bušilica opremljena je zaključavanjem za konstantni rad za udoban i jednostavan rad

ELEKTRONSKA KONTROLA BRZINE

Na svim razinama snage elektronička kontrola brzine prilagođava se svakom materijalu i primjeni

NAJVEĆI KAPACITET BUŠENJA

S nevjerojatnih 10 J, čekić bušilica omogućuje bušenje do 40 mm kapaciteta u betonu

Čekić bušilica 5 kg
TE-RH 40 3F



ČEKIĆ BUŠILICE 5 KG



	TE-RH 40 3F EXPERT	TE-RH 38 3F EXPERT
Napon	220 - 240 V ~ 50 Hz	220 - 240 V ~ 50 Hz
Snaga	1050 W	1050 W
Broj okretaja	0 - 480 min ⁻¹	0 - 500 min ⁻¹
Broj udaraca	0 - 4100 min ⁻¹	0 - 4100 min ⁻¹
Snaga udarca	10,0 J	9,0 J
Kapacitet bušenja beton	40 mm	38 mm
Stezna glava	SDS-max	SDS-max
Težina proizvoda	7,4 kg	6,7 kg
Elektronska kontrola brzine	•	•
Anti-vibracijska ručka	•	•
Klizna spojka za veću sigurnost pri radu	•	•
Pneumatski udarni mehanizam	•	•
Funkcije	3	3
Zaključavanje za konstantni rad	•	-
Indikator servisnog intervala	-	•
Dotatna ručka	•	•
Metalni graničnik dubine	-	•
Pribor	2 SDS-max dlijeta	-
Pakiranje	E-Box	E-Box
Broj artikla	42.579.35	42.579.59



4 006825 655926



4 006825 663884

ČEKIĆ BUŠILICE 5 KG



	TE-RH 32 4F Kit EXPERT	TE-RH 32-1600 4F EXPERT NOVO
Napon	230 V ~ 50 Hz	220 - 240 V ~ 50/60 Hz
Snaga	1250 W	1600 W
Broj okretaja	0 - 850 min ⁻¹	0 - 800 min ⁻¹
Broj udaraca	0 - 4100 min ⁻¹	0 - 4600 min ⁻¹
Snaga udarca	5,0 J	4,5 J
Kapacitet bušenja beton	32 mm	32 mm
Stezna glava	SDS-plus	SDS-plus
Težina proizvoda	5,7 kg	5,6 kg
Elektronska kontrola brzine	•	•
Anti-vibracijska ručka	•	•
Klizna spojka za veću sigurnost pri radu	•	•
Pneumatski udarni mehanizam	•	•
Funkcije	4	4
Zaključavanje za konstantni rad	-	-
Indikator servisnog intervala	•	-
Dodatna ručka	•	•
Metalni graničnik dubine	•	•
Pribor	3 SDS-plus svrdla / 2 SDS-plus dlijeta	-
Pakiranje	E-Box	E-Box
Broj artikla	42.579.44	42.585.08



4 006825 650419



4 006825 666601

ČEKIĆ BUŠILICA 5 KG



	TC-RH 900 CLASSIC
Napon	230 V ~ 50 Hz
Snaga	900 W
Broj okretaja	850 min ⁻¹
Broj udaraca	4000 min ⁻¹
Snaga udarca	3,0 J
Kapacitet bušenja beton	26 mm
Stezna glava	SDS-plus
Težina proizvoda	4,1 kg
Anti-vibracijska ručka	-
Klizna spojka za veću sigurnost pri radu	•
Pneumatski udarni mehanizam	•
Funkcije	3
Dodatna ručka	•
Metalni graničnik dubine	•
Pakiranje	Kovčeg
Broj artikla	42.582.37



4 006825 593242

ČEKIĆI ZA RAZBIJANJE



	TP-DH 50 PROFESSIONAL	TC-DH 43 CLASSIC
Napon	220 - 240 V ~ 50 Hz	230 V ~ 50 Hz
Snaga	1700 W	1600 W
Broj udaraca	1800 min ⁻¹	1800 min ⁻¹
Snaga udarca	50 J	43 J
Stezna glava	SDS-hex	SDS-hex
Težina proizvoda	18,4 kg	14,6 kg
Pneumatski udarni mehanizam	•	•
Anti-vibracijska ručka	•	-
Zaključavanje za konstantni rad	•	-
Dodatna ručka	•	•
Pribor	1 šiljasto dlijeto, 1 ravno dlijeto	1 šiljasto dlijeto, 1 ravno dlijeto
Pakiranje	E-Box s kotačima	Kovčeg
Broj artikla	41.391.30	41.390.87



4 006825 630305



4 006825 638899

ČEKIĆ ZA RAZBIJANJE



	TE-DH 32 EXPERT	TE-DH 12 EXPERT	TE-DH 5 EXPERT
Napon	230 - 240 V ~ 50 Hz	220 - 240 V ~ 50-60 Hz	220 - 240 V ~ 50 Hz
Snaga	1500 W	1050 W	750 W
Broj udaraca	1900 min ⁻¹	4100 min ⁻¹	4300 min ⁻¹
Snaga udarca	32 J	12 J	5 J
Stezna glava	SDS-max	SDS-max	SDS-plus
Težina proizvoda	10,8 kg	6,8 kg	3,9 kg
Pneumatski udarni mehanizam	•	•	•
Anti-vibracijska ručka	•	•	•
Zaključavanje za konstantni rad	•	•	•
Dodatna ručka	•	•	•
Pribor	1 šiljasto dlijeto, 1 ravno dlijeto	1 šiljasto dlijeto, 1 ravno dlijeto	1 šiljasto dlijeto, 1 ravno dlijeto
Pakiranje	E-Box	E-Box	E-Box Basic
Broj artikla	41.390.99	41.391.00	41.391.35



4 006825 650334



4 006825 625219



4 006825 657555

MJEŠAČI ZA BOJU I LJEPILO



	TE-MX 1600-2 CE Twin EXPERT	TE-MX 1600-2 CE EXPERT
Napon	220 - 240 V ~ 50 Hz	220 - 240 V ~ 50 Hz
Snaga	1600 W	1600 W
Broj okretaja	180 - 460 / 300 - 750 min ⁻¹	0 - 460 / 0 - 750 min ⁻¹
Prihvat alata za miješanje	Hex 13 mm	M14
Težina proizvoda	3,7 kg (bez miješalice)	3,5 kg (bez miješalice)
Elektronska kontrola brzine	•	•
Elektronika konstantne brzine	•	•
Polagano pokretanje	•	•
Montaža osovine za stacionarni rad	•	•
Mekani rukohvat	•	•
Pribor	Dupla miješalica za žbuku (Ø 120 mm)	1 miješalica za žbuku (Ø 133 mm)
Pakiranje	Karton	Karton
Broj artikla	42.585.61	42.585.55



4 006825 614558



4 006825 602258

MJEŠAČI ZA BOJU I LJEPILO



	TC-MX 1400-2 E CLASSIC	TC-MX 1200 E CLASSIC
Napon	220 - 240 V ~ 50 Hz	220 - 240 V ~ 50 Hz
Snaga	1400 W	1200 W
Broj okretaja	0 - 480 / 0 - 780 min ⁻¹	0 - 680 min ⁻¹
Prihvat alata za miješanje	M14	M14
Težina proizvoda	3,5 kg (bez miješalice)	3,2 kg (bez miješalice)
Elektronska kontrola brzine	•	•
Elektronika konstantne brzine	-	-
Polagano pokretanje	•	•
Montaža osovine za stacionarni rad	•	•
Mekani rukohvat	•	-
Pribor	1 miješalica za žbuku (Ø 133 mm)	1 miješalica za žbuku (Ø 100 mm)
Pakiranje	Karton	Karton
Broj artikla	42.585.50	42.585.45



4 006825 602241



4 006825 616620

KUTNE BRUSILICE 230 MM



	TE-AG 230 EXPERT	TE-AG 230/2000 EXPERT
Napon	230 V ~ 50 Hz	230 V ~ 50 Hz
Snaga	2350 W	2000 W
Broj okretaja	6500 min ⁻¹	6500 min ⁻¹
Promjer rezne ploče	230 mm	230 mm
Težina proizvoda	6,0 kg	5,4 kg
Zaštita rezne ploče s brzim podešavanjem	•	•
Blokada osovine	•	•
Mekani rukohvat	•	•
Dodatna ručka	Može se postaviti u 3 pozicije	Može se postaviti u 3 pozicije
Polagano pokretanje	•	•
Anti-vibracijska ručka	•	-
Okretna ručka	•	-
Ključ za pritezanje rezne ploče	•	•
Pribor	-	-
Pakiranje	Karton	Karton
Broj artikla	44.308.70	44.308.40



KUTNE BRUSILICE 125 MM



	TE-AG 125 CE EXPERT	TE-AG 125/1010 CE Q EXPERT
Napon	220 - 240 V ~ 50 Hz	220 - 240 V ~ 50 Hz
Snaga	1100 W	1010 W
Broj okretaja	3000 - 12000 min ⁻¹	4000 - 12000 min ⁻¹
Promjer rezne ploče	125 mm	125 mm
Težina proizvoda	2,5 kg	2,0 kg
Elektronika konstantne brzine	•	•
Zaštita protiv ponovnog pokretanja	-	•
Sigurnosni prekidač	•	•
Zaštita rezne ploče s brzim podešavanjem	•	•
Blokada osovine	•	•
Mekani rukohvat	•	•
Dodatna ručka	Može se postaviti u 3 pozicije	Može se postaviti u 2 pozicije
Polagano pokretanje	•	•
LED indikator radnog statusa	•	-
Ključ za pritezanje rezne ploče	•	-
Pribor	-	Matica za brzo otpuštanje
Pakiranje	Karton	Karton
Broj artikla	44.308.60	44.308.90



KUTNE BRUSILICE 125 MM



	TE-AG 125/750 EXPERT	TC-AG 125/850 CLASSIC
Napon	230 V ~ 50 Hz	220 - 240 V ~ 50 Hz
Snaga	750 W	850 W
Broj okretaja	12000 min ⁻¹	12000 min ⁻¹
Promjer rezne ploče	125 mm	125 mm
Težina proizvoda	1,9 kg	1,6 kg
Elektronika konstantne brzine	-	-
Zaštita protiv ponovnog pokretanja	•	•
Sigurnosni prekidač	•	•
Zaštita rezne ploče s brzim podešavanjem	•	-
Blokada osovine	•	•
Mekani rukohvat	•	•
Dodatna ručka	Može se postaviti u 3 pozicije	Može se postaviti u 2 pozicije
Polagano pokretanje	-	•
LED indikator radnog statusa	-	-
Ključ za pritezanje rezne ploče	•	•
Pribor	-	-
Pakiranje	Karton	Karton
Broj artikla	44.308.80	44.309.71



KUTNA BRUSILICA 115 MM



	TC-AG 115/750 CLASSIC
Napon	220 - 240 V ~ 50 Hz
Snaga	750 W
Broj okretaja	12000 min ⁻¹
Promjer rezne ploče	115 mm
Težina proizvoda	1,7 kg
Zaštita protiv ponovnog pokretanja	•
Sigurnosni prekidač	•
Zaštita rezne ploče s brzim podešavanjem	-
Blokada osovine	•
Mekani rukohvat	•
Dodatna ručka	Može se postaviti u 2 pozicije
Polagano pokretanje	•
Kopča za kabel	-
Ključ za pritezanje rezne ploče	•
Pribor	-
Pakiranje	Karton
Broj artikla	44.309.60



GLODALICE ZA UTORE U ZIDU



	TE-MA 1700 EXPERT	TE-MA 1500 EXPERT	TC-MA 1300 CLASSIC
Napon	220 - 240 V ~ 50 Hz	220 - 240 V ~ 50 Hz	230 V ~ 50 Hz
Snaga	1700 W	1500 W	1320 W
Broj okretaja	7000 min ⁻¹	8500 min ⁻¹	9000 min ⁻¹
Rezna ploča	Ø 150 x Ø 22 mm	Ø 125 x Ø 22 mm	Ø 125 x Ø 22,2 mm
Dubina kanala	8 - 40 mm	5- 30 mm	8 - 30 mm
Širina kanala	8 - 38 mm	8 - 30 mm	8 - 26 mm
Težina proizvoda	5,8 kg	4,8 kg	4,9 kg
Beskonačno podesiva dubina reza	•	•	•
Zaštita protiv preopterećenja	•	•	•
Polagano pokretanje	•	•	•
Blokada osovine	•	•	•
Usisavanje prašine	•	•	•
Dijamantna rezna ploča	4 kom	2 kom	2 kom
Torba	•	•	-
Pakiranje	Karton	Karton	Karton
Broj artikla	43.507.40	43.507.35	43.507.30



GLODALICA ZA UTORE



	TC-BJ 900 CLASSIC
Napon	230 V ~ 50 Hz
Snaga	860 W
Broj okretaja	11000 min ⁻¹
Maks. dubina reza	14 mm
Podešavanje kuta nagiba	90°
Rezač utora	Ø 100 x Ø 22 x 3,8 mm
Težina proizvoda	3,3 kg
Beskonačno podesiv kut	•
Beskonačno podesiva visina	•
Brzo podešavanje dubine glodanja	3 postavke
Blokada osovine	•
Usisavanje prašine	Vrećica za prašinu
Ključ za pritezanje rezne ploče	•
Pakiranje	Karton
Broj artikla	43.506.20



GLODALICE



	TE-RO 1255 E EXPERT	TC-RO 1155 E CLASSIC
Napon	230 V ~ 50 Hz	230 - 240 V ~ 50 Hz
Snaga	1200 W	1100 W
Broj okretaja	11000 - 30000 min ⁻¹	11000 - 30000 min ⁻¹
Dubinski hod	55 mm	55 mm
Maks. rez za oblikovanje	30 mm	30 mm
Težina proizvoda	3,3 kg	3,0 kg
Elektronska kontrola brzine	•	•
Fino podešavanje dubine reza	•	•
Štitnik za strugotine	•	•
Blokada osovine	•	•
Mekani rukohvat	•	-
Kopča za kabel	•	-
Paralelni graničnik	•	•
Kompas	•	•
Čahura za kopiranje	•	•
Promjer stezaljke	6 mm / 8 mm	6 mm / 8 mm
Pakiranje	Karton	Karton
Broj artikla	43.504.90	43.504.70



4 006825 537215



4 006825 580143

BLANJE



	TE-PL 900 EXPERT	TC-PL 750 CLASSIC
Napon	230 V ~ 50 Hz	220 - 240 V ~ 50 Hz
Snaga	900 W	750 W
Broj okretaja	15000 min ⁻¹	17000 min ⁻¹
Širina struganja	82 mm	82 mm
Dubina struganja	3 mm	2 mm
Dubina pregiba	18 mm	10 mm
Težina proizvoda	3,6 kg	2,4 kg
Mekani rukohvat	•	•
Automatska zaštita oštrica	•	•
Aluminijsko podnožje blanje	•	•
V žlijebovi	3 kom	1 kom
Izbacivanje strugotina	Dvostrano	Jednostrano
Kopča za kabel	•	-
Paralelni graničnik	•	•
Graničnik dubine pregiba	•	•
Oštrice (reverzibilne oštrice)	1 par, karbidne	1 par, karbidne
Pakiranje	Karton	Karton
Broj artikla	43.453.20	43.453.10



4 006825 645668



4 006825 615029

UBODNE PILE



	TC-JS 85 CLASSIC	TC-JS 80/1 CLASSIC
Napon	230 V ~ 50 Hz	220 - 240 V ~ 50/60 Hz
Snaga	620 W	550 W
Broj uboda	800 - 3000 min ⁻¹	1000 - 3000 min ⁻¹
Dubina reza (drvo/plastika/čelik)	85 / 12 / 8 mm	80 / 12 / 10 mm
Težina proizvoda	2,0 kg	1,9 kg
Univerzalni prihvatač alata	-	-
Funkcija njihanja	4 postavke	4 postavke
Podšavanje kuta rezanja bez dodatnog alata	•	-
Zamjena lista pile bez dodatnog alata	•	•
Priključak za usisavač	•	•
LED svjetlo	-	-
Funkcija ispuhivanja prašine	•	-
Vodilica reza	-	-
Rezni list	1 kom (drvo)	-
Pribor	Paralelni graničnik, štitnik od strugotina	-
Pakiranje	Karton	Karton
Broj artikla	43.211.40	43.211.45



4 006825 576573



4 006825 619737

UBODNA PILA



	TC-JS 60/1 CLASSIC
Napon	220 - 240 V ~ 50 Hz
Snaga	400 W
Broj uboda	1000 - 3000 min ⁻¹
Dubina reza (drvo/plastika/čelik)	60 / 10 / 6 mm
Težina proizvoda	1,7 kg
Univerzalni prihvatač alata	-
Funkcija njihanja	-
Podšavanje kuta rezanja bez dodatnog alata	-
Zamjena lista pile bez dodatnog alata	•
Priključak za usisavač	•
LED svjetlo	-
Funkcija ispuhivanja prašine	-
Vodilica reza	-
Rezni list	-
Pribor	-
Pakiranje	Karton
Broj artikla	43.211.35



4 006825 619720

RUČNE KRUŽNE PILE



	TE-CS 190/1 EXPERT	TC-CS 1410 CLASSIC
Napon	230 V ~ 50 Hz	220 - 240 V ~ 50 Hz
Snaga	1500 W	1410 W
Broj okretaja	5500 min ⁻¹	5500 min ⁻¹
List pile	Ø 190 x Ø 30 mm	Ø 190 x Ø 30 mm
Dubina reza 90°	66 mm	67 mm
Dubina reza 45°	48 mm	46 mm
Težina proizvoda	5,2 kg	4,3 kg
Podešavanje bez dodatnog alata (dubina / kut)	•	•
LED svjetlo	•	-
Aluminijsko podnožje pile	•	-
Blokada osovine	•	•
Dvostrano sigurnosno zaključavanje	•	•
Adapter za usisavanje prašine	•	•
Mekani rukohvat	•	•
Pribor	Paralelni graničnik	Paralelni graničnik
Pakiranje	Karton	Karton
Broj artikla	43.310.05	43.310.50



RUČNE KRUŽNE PILE



	TE-CS 165 EXPERT	TC-CS 1250 CLASSIC
Napon	230 V ~ 50 Hz	220 - 240 V ~ 50 Hz
Snaga	1200 W	1250 W
Broj okretaja	5500 min ⁻¹	5500 min ⁻¹
List pile	Ø 165 x Ø 16 mm	Ø 165 x Ø 16 mm
Dubina reza 90°	55 mm	55 mm
Dubina reza 45°	40 mm	38 mm
Težina proizvoda	3,8 kg	3,8 kg
Podešavanje bez dodatnog alata (dubina / kut)	•	•
LED svjetlo	-	-
Aluminijsko podnožje pile	•	-
Blokada osovine	•	•
Dvostrano sigurnosno zaključavanje	•	•
Adapter za usisavanje prašine	•	•
Mekani rukohvat	•	•
Pribor	Paralelni graničnik	Paralelni graničnik
Pakiranje	Karton	Karton
Broj artikla	43.310.10	43.310.40



URANJAJUĆA KRUŽNA PILA



	TE-PS 165 EXPERT
Napon	220 - 240 V ~ 50 Hz
Snaga	1200 W
Broj okretaja	5200 min ⁻¹
List pile	Ø 165 x Ø 20 mm
Dubina reza 90°	56 mm
Dubina reza 45°	42 mm
Težina proizvoda	4,8 kg
Podšavanje bez dodatnog alata (dubina / kut)	•
LED svjetlo	-
Aluminijsko podnožje pile	•
Blokada osovine	•
Adapter za usisavanje prašine	•
Mekani rukohvat	•
Vodilica reza	•
Pribor	Paralelni graničnik
Pakiranje	Karton
Broj artikla	43.313.00



4 006825 629668

ODGOVARAJUĆU
VODILICU ZA
URANJAJUĆE I
RUČNE KRUŽNE PILE
PRONAĆI ĆETE NA
STR. 148

MINI RUČNA KRUŽNA PILA



	TC-CS 89 CLASSIC
Napon	220 - 240 V ~ 50 Hz
Snaga	600 W
Broj okretaja	7200 min ⁻¹
List pile	Ø 89 x Ø 10 mm
Dubina reza	27 mm
Težina proizvoda	2,0 kg
Podšavanje dubine reza bez dodatnog alata	•
Aluminijsko podnožje pile	•
Adapter za usisavanje prašine	•
Mekani rukohvat	•
Pribor	2 lista pile (drvo/plastika), 1 dijamantna rezna ploča, paralelni graničnik
Pakiranje	Karton
Broj artikla	43.310.30



4 006825 646054

VIŠENAMJENSKE PILE



	TE-AP 950 E EXPERT	TE-AP 750 E EXPERT
Napon	220 - 240 V ~ 50 Hz	220 - 240 V ~ 50 Hz
Snaga	950 W	750 W
Broj uboda	0 - 2500 min ⁻¹	0 - 2800 min ⁻¹
Visina uboda	28 mm	20 mm
Dubina reza (drvo / čelik)	200 / 20 mm	150 / 10 mm
Debljina lista pile	0,8 - 1,5 mm	0,8 - 1,5 mm
Težina proizvoda	3,2 kg	2,4 kg
Zamjena lista pile bez dodatnog alata	•	•
Podešavanje radne ploče bez upotrebe alata	•	•
Mekani rukohvat	•	•
Pribor	1 KWB list pile (drvo)	1 KWB list pile (drvo)
Pakiranje	Karton	Karton
Broj artikla	43.261.80	43.261.70



VIŠENAMJENSKA PILA



	TC-AP 690 E CLASSIC
Napon	220 - 240 V ~ 50 Hz
Snaga	690 W
Broj uboda	0 - 2800 min ⁻¹
Visina uboda	20 mm
Dubina reza (drvo / čelik)	115 / 10 mm
Debljina lista pile	0,8 - 1,5 mm
Težina proizvoda	2,2 kg
Zamjena lista pile bez dodatnog alata	•
Podešavanje radne ploče bez upotrebe alata	-
Mekani rukohvat	•
Pribor	1 list pile (drvo)
Pakiranje	Karton
Broj artikla	43.261.61



VIŠENAMJENSKI ALATI

BRZOOTPUŠTAJUĆI ZATVARAČ

Brzootpuštajući zatvarač omogućuje brzu izmjenu dodataka bez dodatnog alata

ELEKTRONSKA KONTROLA BRZINE

Za rad prilagođen materijalu i primjeni

Višenamjenski alat
TE-MG 350 EQ

LED SVJETLO

Integrirano LED svjetlo osigurava najbolji pregled radnog područja

MAGNETNI PRIHVAT ALATA

Magnetski prihvati alata podesivi u 12 smjerova za jednostavno i optimalno pozicioniranje dodataka

VIŠENAMJENSKI ALATI



	TE-MG 350 EQ EXPERT NOVO	TE-MG 300 EQ EXPERT	TC-MG 250 CE CLASSIC NOVO
Napon	220 - 240 V ~ 50 Hz	230 - 240 V ~ 50 Hz	220 - 240 V ~ 50 Hz
Snaga	350 W	300 W	250 W
Broj oscilacija / broj okretaja	22000 - 40000 min ⁻¹ / 11000 - 20000 min ⁻¹	22000 - 40000 min ⁻¹ / 11000 - 20000 min ⁻¹	22000 - 40000 min ⁻¹ / 11000 - 20000 min ⁻¹
Kut oscilacija	3,0°	3,2°	3,0°
Veličina brusnog papira	93 x 93 x 93 mm	93 x 93 x 93 mm	93 x 93 x 93 mm
Težina proizvoda	1,3 kg	1,5 kg	1,0 kg
Elektronska kontrola brzine	•	•	•
Elektronika konstantne brzine	•	•	•
Mekani rukohvat	•	•	•
Zaključavanje brzog otpuštanja alata	•	•	-
Magnetski držač alata	•	•	•
LED svjetlo	•	-	-
Trokutasti nosač brusnog papira	•	•	•
Brusni papir	3x P60, 3x P80, 3x P120	3x P60, 3x P120	3x P60, 3x P80, 3x P120
Strugač	•	•	•
Uranjajući list pile	1x drvo/plastika, 1x metal	1x drvo/plastika, 1x metal	1x drvo/plastika
Segmentni list pile	1x drvo/plastika/neobojeni metal, 1x pločice	1x drvo/plastika/neobojeni metal, 1x pločice	-
Adapter za usisavanje prašine	•	•	•
Šesterokutni ključ	-	-	•
Pakiranje	E-Box Basic	Karton	Karton
Broj artikla	44.651.55	44.651.50	44.651.85



AKUMULATORSKI ALAT ZA BRUŠENJE I GRAVIRANJE



	TE-MT 7,2 Li EXPERT
Baterija napon / kapacitet	7,2 V / 1,5 Ah
Vrijeme punjenja	1 h
Broj okretaja	5500 - 26000 min ⁻¹
Čahura za stezanje, Ø	1,6 / 2,4 / 3,2 mm
Težina proizvoda	0,3 kg
Elektronska kontrola brzine	•
Blokada osovine	•
Mekani rukohvat	•
Punjač	•
Set pribora	57-dijelni
Pakiranje	Kutija sa magnetnim zatvaranjem
Broj artikla	44.193.30



4 006825 639353

ALAT ZA BRUŠENJE I GRAVIRANJE



	TC-MG 135 E CLASSIC
Napon	230 V ~ 50 Hz
Snaga	135 W
Broj okretaja	10000 - 35000 min ⁻¹
Čahura za stezanje, Ø	0,5 / 1,6 / 2,4 / 3,2 mm
Težina proizvoda	0,7 kg
Elektronska kontrola brzine	•
Blokada osovine	•
Mekani rukohvat	•
Set pribora	189-dijelni u kovčegu
Teleskopski stalak	•
Fleksibilna osovina	•
Pakiranje	Kovčeg
Broj artikla	44.191.69



4 006825 585315

VIBRACIONE BRUSILICE



	TE-OS 2520 E EXPERT	TC-OS 1520 CLASSIC
Napon	230 V ~ 50 Hz	230 V ~ 50 Hz
Snaga	250 W	150 W
Brzina oscilacija	14000 - 24000 min ⁻¹	23000 min ⁻¹
Krug oscilacija, Ø	2,0 mm	2,0 mm
Područje brušenja	230 x 115 mm	187 x 90 mm
Veličina brusnog papira, čičak	230 x 115 mm	187 x 93 mm
Veličina brusnog papira, hvataljke	280 x 115 mm	230 x 93 mm
Težina proizvoda	1,9 kg	1,1 kg
Elektronska kontrola brzine	•	-
Čičak	•	•
Hvataljke	•	•
Usisavanje prašine	Kutija za prašinu i adapter za usisavanje prašine	Adapter za usisavanje prašine
Niske vibracije	•	-
Aluminijska brusna ploča	•	-
Mekani rukohvat	•	•
Brusni papir	1x P120	3x P120
Pakiranje	Karton	Karton
Broj artikla	44.606.20	44.606.40



4 006825 592498



4 006825 593693

TRAČNA BRUSILICA



	TC-BS 8038 CLASSIC
Napon	230 V ~ 50 Hz
Snaga	800 W
Brzina brusne trake	380 m/min
Područje brušenja	76 x 142 mm
Veličina brusne trake	76 x 533 mm
Težina proizvoda	3,4 kg
Stacionarna uporaba	-
Podršavanje brusne trake	•
Zamjena brusne trake bez upotrebe alata	•
Usisavanje prašine	Vrećica za prašinu i adapter za usisavanje prašine
Mekani rukohvat	-
Dodatna ručka	•
Preklopna prednja zaštita	-
Brusna traka	1x P80
Stezaljke s vijcima	-
Pakiranje	Karton
Broj artikla	44.662.60



4 006825 598360

TROKUTASTE BRUSILICE



Ilustrativna slika

	TE-DS 20 E EXPERT	TC-DS 20 E CLASSIC NOVO
Napon	230 V ~ 50 Hz	220 - 240 V ~ 50 Hz
Snaga	200 W	200 W
Brzina oscilacija	13000 - 20000 min ⁻¹	12000 - 22000 min ⁻¹
Krug oscilacija, Ø	2,0 mm	2,0 mm
Veličina brusnog papira	93 x 93 x 93 mm	93 x 93 x 93 mm
Težina proizvoda	1,2 kg	0,9 kg
Elektronska kontrola brzine	•	•
Mekani rukohvat	•	•
Čičak	•	•
Usisavanje prašine	Adapter za usisavanje prašine	Adapter za usisavanje prašine
Polagano pokretanje	•	-
Kopča za kabel	•	•
Brusni papir	5x P80, 5x P120	2x P60, 2x P120, 2x P240, 3x P400
Adapter za usisavanje prašine	•	•
Pakiranje	Karton	Karton
Broj artikla	44.642.50	44.642.55



4 006825 580686



4 006825 669671

VIŠENAMJENSKE BRUSILICE



	TE-OS 1320 EXPERT	TH-OS 1016 CLASSIC
Napon	230 V ~ 50 Hz	230 V ~ 50 Hz
Snaga	130 W	100 W
Brzina oscilacija	24000 min ⁻¹	24000 min ⁻¹
Krug oscilacija, Ø	2,0 mm	1,6 mm
Veličina brusnog papira	150 x 150 x 100 mm	150 x 150 x 100 mm
Težina proizvoda	1,0 kg	1,0 kg
Mekani rukohvat	•	•
Čičak	•	•
Usisavanje prašine	Kutija za prašinu i adapter za usisavanje prašine	Vrećica za prašinu i adapter za usisavanje prašine
Kopča za kabel	•	-
Brusni papir	3x P120	1x P120
Pakiranje	Karton	Karton
Broj artikla	44.605.60	44.606.10



4 006825 573169



4 006825 592481

EKSCENTRIČNE BRUSILICE



	TE-RS 40 E EXPERT	TC-RS 425 E CLASSIC NOVO
Napon	230 V ~ 50 Hz	230 - 240 V ~ 50 Hz
Snaga	400 W	425 W
Brzina oscilacija	12000 - 24000 min ⁻¹	12000 - 26000 min ⁻¹
Krug oscilacija, Ø	2,5 mm	2,5 mm
Brusni papir, Ø	125 mm	125 mm
Težina proizvoda	2,1 kg	1,7 kg
Elektronska kontrola brzine	•	•
Čičak	•	•
Usisavanje prašine	Kutija za prašinu i adapter za usisavanje prašine	Vrećica za prašinu i adapter za usisavanje prašine
Mekani rukohvat	•	•
Dodatna ručka	•	-
Brusni papir	-	1x P60, 1x P80, 1x P120
Pakiranje	Karton	Karton
Broj artikla	44.620.00	44.620.05



4 006825 590661



4 006825 664720



BRUSILICA ZA ZIDOVE



Ilustrativna slika

	TC-DWS 225 CLASSIC NOVO
Napon	220 - 240 V ~ 50 Hz
Snaga	1220 W
Broj okretaja	1500 - 2300 min ⁻¹
Brusni papir	Ø 225 mm
Duljina kabela	4,0 m
Težina proizvoda	2,6 kg
Elektronska kontrola brzine	•
Podesiva brusna glava	•
Okrugla brusna ploča	•
Trokutasta brusna ploča	-
Preklopna i podesiva po visini duga drška	-
Potporna noga	-
Brusni papir okrugli	2x P60, 2x P80, 2x P120
Brusni papir trokutasti	-
Brusna mreža okrugla	-
Brusna mreža trokutasta	-
Pakiranje	Karton
Broj artikla	42.599.45



4 006825 668834

BRUSILICE ZA ZIDOVE I STROPOVE

EASY HANDLING

	TE-DW 225 X EXPERT	TC-DW 225 CLASSIC
Napon	230 - 240 V ~ 50 Hz	230 - 240 V ~ 50 Hz
Snaga	750 W	600 W
Broj okretaja	600 - 1800 min ⁻¹	600 - 1500 min ⁻¹
Brusni papir	Ø 225 mm / 285 x 285 x 285 mm	Ø 225 mm
Duljina uređaja	110 - 165 cm	110 - 165 cm
Duljina crijeva	4,0 m	4,0 m
Duljina kabela	4,0 m	4,0 m
Težina proizvoda	3,7 kg	3,2 kg
Elektronska kontrola brzine	•	•
Podesiva brusna glava	•	•
Okrugla brusna ploča	•	•
Trokutasta brusna ploča	•	-
Preklopna i podesiva po visini duga drška	•	•
Potporna noga	•	•
Brusni papir okrugli	1x P60, 1x P80, 1x P120	2x P60, 2x P80, 2x P120
Brusni papir trokutasti	1x P60, 1x P80, 1x P120	-
Brusna mreža okrugla	1x P120	-
Brusna mreža trokutasta	1x P120	-
Pakiranje	E-Box	Kovčeg
Broj artikla	42.599.60	42.599.30



4 006825 634518



4 006825 601671

ELEKTRIČNI SISTEMI ZA PRSKANJE BOJE



	TC-SY 700 S CLASSIC	TC-SY 600 S CLASSIC
Napon	220 - 240 V ~ 50 Hz	220 - 240 V ~ 50 Hz
Snaga	700 W	600 W
Dostavni kapacitet	1000 ml/min	1000 ml/min
Kapacitet spremnika	1000 ml	800 ml
Duljina crijeva	3,5 m	1,8 m
Težina proizvoda	3,0 kg	2,3 kg
Obrada	Lakovi, premazi, boje za unutarnje zidove	Lakovi, premazi, boje za unutarnje zidove
Odvojiva glava za raspršivanje	•	•
Kontrola dostavnog kapaciteta boje	•	•
Mlaz boje	Vertikalni, horizontalni i okrugli mlaz	Vertikalni, horizontalni i okrugli mlaz
Mekani rukohvat	•	•
Ovjesno učvršćivanje	•	•
Remen za nošenje	•	-
Mlaznice	Ø 2,5 mm, Ø 3,0 mm	Ø 2,5 mm, Ø 3,0 mm
Četka za čišćenje i igla	•	•
Spremnik za testiranje viskoziteta	•	•
Spremnik za boju s poklopcem	1000 ml	800 ml
Pakiranje	Karton	Karton
Broj artikla	42.600.20	42.600.15



4 006825 614596



4 006825 614572

ELEKTRIČNI PIŠTOLJI ZA PRSKANJE BOJE



	TC-SY 500 P CLASSIC	TC-SY 400 P CLASSIC
Napon	220 - 240 V ~ 50 Hz	220 - 240 V ~ 50 Hz
Snaga	500 W	400 W
Dostavni kapacitet	550 ml/min	500 ml/min
Kapacitet spremnika	1000 ml	800 ml
Težina proizvoda	1,3 kg	1,3 kg
Obrada	Lakovi, premazi	Lakovi, premazi
Odvojiva glava za raspršivanje	•	•
Kontrola dostavnog kapaciteta boje	•	•
Mlaz boje	Vertikalni, horizontalni i okrugli mlaz	Vertikalni, horizontalni i okrugli mlaz
Mekani rukohvat	•	•
Uređaj za ovjes	•	•
Mlaznice	Ø 2,0 mm, Ø 2,5 mm	Ø 2,0 mm, Ø 2,5 mm
Četka za čišćenje i igla	•	•
Spremnik za testiranje viskoziteta	•	•
Spremnik za boju s poklopcem	1000 ml	800 ml
Pakiranje	Karton	Karton
Broj artikla	42.600.10	42.600.05



4 006825 613780



4 006825 613773

PIŠTOLJ ZA VRUĆE LJEPLJENJE



	TC-GG 30 CLASSIC
Napon	220 - 240 V ~ 50 Hz
Snaga	30 W
Vrijeme zagrijavanja	300 s
Maks. temperatura	195 °C
Patrone za ljepljenje, Ø	11 mm
Patrone za ljepljenje, duljina	150 mm
Težina proizvoda	0,2 kg
Mehaničko uvlačenje patrona za ljepljenje	•
Kontrolni prozor	•
Potporni stalak	•
Patrone za ljepljenje	3 kom
Standardna mlaznica	•
Ravna mlaznica	•
Produžna mlaznica	•
Pakiranje	Karton
Broj artikla	45.221.70



4 006825 614022

AKU PIŠTOLJ ZA VRUĆE LJEPLJENJE



	TC-CG 3,6/1 Li CLASSIC
Li-Ion baterija napon / kapacitet	3,6 V / 1,5 Ah
Vrijeme punjenja	3 - 5 h
Vrijeme zagrijavanja	30 s
Maks. temperatura	160 °C
Patrone za ljepljenje, Ø	7 mm
Patrone za ljepljenje, duljina	150 mm
Težina proizvoda	0,3 kg
LED indikator razine temperature	•
Mehaničko uvlačenje patrona za ljepljenje	•
Potporni stalak	•
Pribor	4 kom patrona za ljepljenje
Pakiranje	Limena kutija
Broj artikla	45.221.90



4 006825 637854

ELEKTRIČNA KLAMERICA



	TC-EN 20 E CLASSIC
Napon	220 - 240 V ~ 50 Hz
Izbacivanje u minuti	20
Tip spajalica	53
Duljina spajalica	6 - 14 mm
Širina spajalica	11,4 mm
Visina spajalica	0,75 mm
Čavličić tip	47
Čavličić duljina	14 mm
Čavličić veličina	1,16 - 1,27 mm
Težina proizvoda	1,1 kg
Zaštitni nos	•
Mekani rukohvat	•
Spremnik s indikatorom razine	•
Postavke snage udarca	•
Spajalice (tip 53)	1000 kom
Čavličić (tip 47)	500 kom
Pakiranje	Karton
Broj artikla	42.578.90



4 006825 615647

AKUMULATORSKA KLAMERICA



	TC-CT 3,6 Li CLASSIC
Napon	3,6 V
Kapacitet baterije	1,5 Ah
Vrijeme punjenja	3 - 5 h
Izbacivanje u minuti	30
Tip spajalica	53
Duljina spajalica	6 - 14 mm
Širina spajalica	11,4 mm
Visina spajalica	0,75 mm
Težina proizvoda	0,9 kg
Zaštitni nos	•
Mekani rukohvat	•
Spremnik s indikatorom razine	•
Indikator stanja napunjenosti	•
Spajalice (tip 53)	1000 kom
Punjač	•
Pakiranje	Limena kutija
Broj artikla	42.578.80



4 006825 607291

FEN ZA VRUĆI ZRAK



	TE-HA 2000 E EXPERT
Napon	220 - 240 V ~ 50 Hz
Snaga	2000 W
Količina zraka	250 / 250 / 500 l/min
Temperatura	50 / 50 - 550 / 50 - 550 °C
Težina proizvoda	0,9 kg
Kontrolni sistem količine zraka i temperature	3 postavke
Funkcija hlađenja	•
Keramički grijač	•
Zaštita od pregrijavanja	•
Stacionarna upotreba	•
Podešavanje temperature, 9 postavki	•
Široka mlaznica	•
Redukcijska mlaznica	•
Reflektor mlaznica	•
Toplinska mlaznica	•
Strugač boje	-
Pakiranje	Karton
Broj artikla	45.201.95



4 006825 602678

FENOVI ZA VRUĆI ZRAK



	TH-HA 2000/1 CLASSIC	TC-HA 2000/1 CLASSIC
Napon	230 / 240 V ~ 50 Hz	230 / 240 V ~ 50 Hz
Snaga	2000 W	2000 W
Količina zraka	300 / 500 l/min	300 / 500 l/min
Temperatura	350 / 550 °C	350 / 550 °C
Težina proizvoda	0,5 kg	0,5 kg
Kontrolni sistem količine zraka i temperature	2 postavke	2 postavke
Funkcija hlađenja	-	-
Keramički grijač	-	-
Zaštita od pregrijavanja	•	•
Stacionarna upotreba	•	•
Podešavanje temperature, 9 postavki	-	-
Široka mlaznica	•	•
Redukcijska mlaznica	•	•
Reflektor mlaznica	•	-
Toplinska mlaznica	•	-
Strugač boje	•	-
Pakiranje	Karton	Karton
Broj artikla	45.201.79	45.201.84



4 006825 593235



4 006825 602227

360° LASERSKI NIVELIR



	TE-LL 360 EXPERT
Dioda lasera	650 nm (vodoravno), 635 nm (okomito)
Klasa lasera	2
Područje rada Ø	20 m
Preciznost	+/- 0,4 mm/m
Vrijeme samoniveliranja	< 5 s
Raspon niveliranja	+/- 4°
Priključak stativa	1/4"
Težina proizvoda	0,3 kg
Laserski križ	•
Vodoravna i/ili okomita laserska linija	•
Vodoravna 360° laserska linija	•
Samoniveliranje	•
Digitalna libela	•
Mekani rukohvat	•
Transportna torba	•
Zidni nosač podesiv po visini	•
Univerzalna stezaljka	-
Baterije	-
Pakiranje	Karton
Broj artikla	22.701.10



LASERSKI NIVELIRI U AKCIJI.

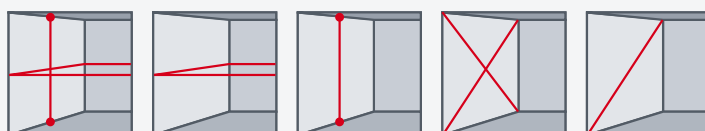

FUNKCIJE

- 1** Funkcija niveliranja: Einhell laserski nivelir pomaže u jednostavnom postavljanju predmeta na istu razinu.
- 2** Einhell laserski nivelir istodobno projicira okomitu i vodoravnu lasersku liniju, koje možete koristiti da biste jednostavno poravnali predmete precizno i ravnomjerno (vidi sliku na str. 101 lijevo).
- 3** TE-LL 360 projicira vodoravnu liniju od 360° za jednostavno i precizno poravnavanje predmeta u sobi (vidi sliku na str. 101 desno).

LASERSKI NIVELIR

	TC-LL 2 CLASSIC
Dioda lasera	635 nm
Klasa lasera	2
Područje rada	8 m
Preciznost	+/- 0,5 mm/m
Vrijeme samoniveliranja	< 5 s
Raspon niveliranja	+/- 4°
Priključak stativa	1/4"
Težina proizvoda	0,2 kg
Laserski križ	•
Vodoravna i/ili okomita laserska linija	•
Vodoravna 360° laserska linija	-
Samoniveliranje	•
Digitalna libela	•
Mekani rukohvat	•
Torba	•
Zidni nosač podesiv po visini	-
Univerzalna stezaljka	•
Baterije	-
Pakiranje	Karton
Broj artikla	22.701.05



4 006825 616231



LASERSKI DALJINOMJERI



	TC-LD 50 CLASSIC	TC-LD 25 CLASSIC
Dioda lasera	635 nm	635 nm
Klasa lasera	2	2
Raspon mjerenja	0,05 - 50 m	0,05 - 25 m
Preciznost mjerenja	+/- 2,0 mm	+/- 3,0 mm
Automatsko isključivanje	od 3 min	od 3 min
Referenca mjerenja	Prednji rub, stražnji rub, središnja točka	Prednji rub i stražnji rub
Težina proizvoda	0,1 kg	0,1 kg
Mjerenje duljina, površina i volumena	•	•
Zbrajanje i oduzimanje	Duljine, površine i volumena	-
Kontinuirano mjerenje s min. / maks. funkcijom	•	•
Sigurnosna funkcija	•	•
Pitagorina funkcija	•	-
Funkcija nagiba	•	-
Automatsko spremanje zadnjeg mjerenja	20	-
Mekani rukohvat	•	•
Transportna torba	•	•
Baterije	-	-
Pakiranje	Karton	Karton
Broj artikla	22.700.80	22.700.75



LASERSKI DALJINOMJERI U AKCIJI – SAVRŠENA PRECIZNOST.

- 1** Jednostavno mjerenje površina, npr. odrediti količinu potrebne boje na zidu.
- 2** Funkcija nagiba: Sposobnost stvaranja unaprijed definiranog ujednačenog razmaka pomoću funkcije nagiba, npr. za određivanje ispravnog razmaka između ogradnih stupova. (pogledajte sliku dolje lijevo).
- 3** Jednostavno mjerenje udaljenosti, npr. odrediti potrebnu količinu zidnih lajsni.
- 4** Jednostavno mjerenje volumena, npr. za određivanje volumena prostorije za klimatizacijske sustave.
- 5** Neizravno određivanje visine i duljine na teško dostupnim ili nedostupnim mjestima pomoću Pitagorine funkcije (vidi sliku dolje desno).

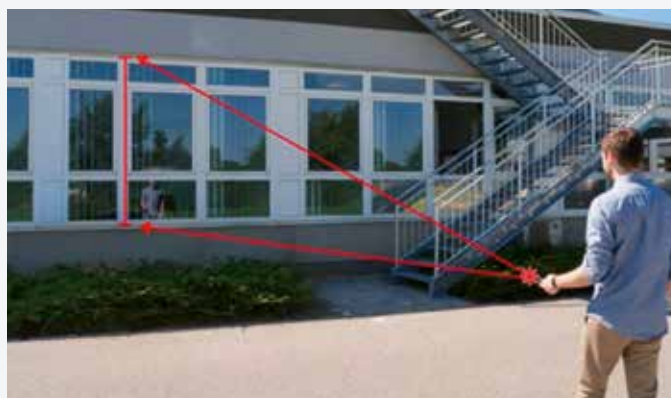

LASERSKI UREĐAJ ZA NIVELIRANJE



	TC-LL 1 CLASSIC
Dioda lasera	650 nm
Klasa lasera	2
Područje rada	Laserska linija: 5 m, laserska točka: 20 m
Preciznost	+/- 0,5 mm/m
Težina proizvoda	0,1 kg
Funkcija libele	•
Mekani rukohvat	•
Fleksibilni zidni nosač	•
Baterije	-
Pakiranje	Karton
Broj artikla	22.700.95



4 006825 616217

DIGITALNI DETEKTOR



	TC-MD 50 CLASSIC
Maks. dubina detekcije drvo	19 mm
Maks. dubina detekcije neželjeznih metala	19 mm
Maks. dubina detekcije željeznih metala	50 mm
Maks. dubina detekcije bakra	38 mm
Maks. dubina detekcije žice pod naponom	50 mm
Automatsko isključivanje	od 1 min
Težina proizvoda	0,1 kg
Zvučni signal upozorenja	•
Zidna zaštita	•
Mekani rukohvat	•
Baterije	-
Pakiranje	Karton
Broj artikla	22.700.90



4 006825 616200

STACIONARNI STROJEVI





POTEZNE PREKLOPNE PILE



Ilustrativna slika



Ilustrativna slika

	TE-SM 10 L Dual EXPERT	NOVO	TE-SM 2534 Dual EXPERT
Napon	220 - 240 V ~ 50 Hz		230 - 240 V ~ 50 Hz
Snaga	2100 W S6 25%		1800 W S1
Broj okretaja	4700 min ⁻¹		5100 min ⁻¹
List pile	Ø 254 x Ø 30 mm		Ø 250 x Ø 30 mm
Broj zuba	48		48
Raspon zakretanja	-47° do +47°		-47° do +47°
Podešavanje kuta lista pile	-45° do +45°		-45° do +45°
Maks. širina reza 90°	305 x 85 mm		310 x 90 mm
Težina proizvoda	15,0 kg		15,7 kg
Nagib lista pile	Lijevo / desno		Lijevo / desno
Laser	•		•
Svjetlo	-		•
Polagano pokretanje	-		•
X-Tend podrška za rad s krajnjim graničnikom	-		•
Lijevak za hvatanje piljevine	•		-
Brzo podešavanje stola pile	•		-
Brzo podešavanje nagiba glave pile	•		-
Precizni TCT list pile	1 kom		1 kom
Broj artikla	43.008.77		43.008.70



4 006825 659238



4 006825 599534

POTEZNE PREKLOPNE PILE



Ilustrativna slika



	TC-SM 254 CLASSIC	TC-SM 2531/2 U CLASSIC
Napon	220 - 240 V ~ 50 Hz	230 - 240 V ~ 50 Hz
Snaga	1900 W S6 25%	1900 W S1
Broj okretaja	5000 min ⁻¹	4800 min ⁻¹
List pile	Ø 254 x Ø 30 mm	Ø 254 x Ø 30 mm
Broj zuba	48	48
Raspon zakretanja	-47° do +47°	-45° do +45°
Podešavanje kuta lista pile	0° do 45° na lijevo	0° do 45° na lijevo
Maks. širina reza 90°	305 x 85 mm	310 x 70 mm
Težina proizvoda	14,9 kg	17,8 kg
Nagib lista pile	Lijevo	Lijevo
Laser	•	•
Lijevak za hvatanje piljevine	•	-
Brzo podešavanje stola pile	•	-
Brzo podešavanje nagiba glave pile	-	-
Postolje pile	-	Radna visina 84 cm
Precizni TCT list pile	1 kom	1 kom
Broj artikla	43.003.85	43.008.05



4 006825 635713



4 006825 645637

POTEZNE PREKLOPNE PILE



Ilustrativna slika



Ilustrativna slika

	TE-SM 2131 Dual EXPERT	TE-SM 8 L Dual EXPERT NOVO
Napon	230 - 240 V ~ 50 Hz	220 - 240 V ~ 50 Hz
Snaga	1600 W S6 20%	1800 W S6 25%
Broj okretaja	5000 min ⁻¹	5000 min ⁻¹
List pile	Ø 210 x Ø 30 mm	Ø 216 x Ø 30 mm
Broj zuba	48	48
Raspon zakretanja	-47° do +47°	-47° do +47°
Podešavanje kuta lista pile	-45° do +45°	-45° do +45°
Maks. širina reza 90°	310 x 65 mm	305 x 65 mm
Težina proizvoda	12,5 kg	13,7 kg
Nagib lista pile	Lijevo / desno	Lijevo / desno
Laser	•	•
Svjetlo	•	-
Polagano pokretanje	•	-
X-Tend podrška za rad s krajnjim graničnikom	•	-
Lijevak za hvatanje piljevine	-	•
Brzo podešavanje stola pile	-	•
Brzo podešavanje nagiba glave pile	-	•
Precizni TCT list pile	1 kom	1 kom
Broj artikla	43.008.60	43.008.66



4 006825 599527



4 006825 659221

POTEZNA PREKLOPNA PILA



Ilustrativna slika

	TC-SM 216 CLASSIC
Napon	220 - 240 V ~ 50 Hz
Snaga	1600 W S6 25%
Broj okretaja	5200 min ⁻¹
List pile	Ø 216 x Ø 30 mm
Broj zuba	48
Raspon zakretanja	-47° do +47°
Podešavanje kuta lista pile	0° do 45° na lijevo
Maks. širina reza 90°	305 x 65 mm
Težina proizvoda	12,7 kg
Nagib lista pile	Lijevo
Laser	•
Svjetlo	-
Polagano pokretanje	-
X-Tend podrška za rad s krajnjim graničnikom	-
Lijevak za hvatanje piljevine	•
Brzo podešavanje stola pile	•
Brzo podešavanje nagiba glave pile	-
Precizni TCT list pile	1 kom
Broj artikla	43.003.80



4 006825 635706

PREKLOPNA PILA



Ilustrativna slika

TC-MS 216 CLASSIC	
Napon	220 - 240 V ~ 50 Hz
Snaga	1600 W S6 25%
Broj okretaja	5000 min ⁻¹
List pile	Ø 216 x Ø 30 mm
Broj zuba	48
Raspon zakretanja	-47° do +47°
Podšavanje kuta lista pile	0° do 45° na lijevo
Maks. širina reza 90°	120 x 60 mm
Težina proizvoda	8,3 kg
Nagib lista pile	Lijevo
Laser	-
Lijevak za hvatanje piljevine	•
Precizni TCT list pile	1 kom
Broj artikla	43.003.70



4 006825 635683

KOMBINIRANA KRUŽNA PILA



Ilustrativna slika

TC-MS 3017 T CLASSIC	
Napon	230 - 240 V ~ 50 Hz
Snaga	2000 W S1
Broj okretaja	4200 min ⁻¹
List pile	Ø 305 x Ø 30 mm
Broj zuba	40
Raspon zakretanja	-45° do +45°
Podšavanje kuta lista pile	0° do 45° na lijevo
Maks. širina reza 90°	170 x 85 mm
Težina proizvoda	18,8 kg
Nagib lista pile	Lijevo
Laser	-
Lijevak za hvatanje piljevine	-
Precizni TCT list pile	1 kom
Broj artikla	43.003.47



4 006825 613056

STOLNE KRUŽNE PILE S POSTOLJEM



	TE-CC 250 UF EXPERT	TC-TS 2225 U CLASSIC
Napon	220 - 240 V ~ 50 Hz	220 - 240 V ~ 50 Hz
Snaga	2000 W S6 20%	2200 W S6 25%
Broj okretaja	4500 min ⁻¹	4250 min ⁻¹
List pile	Ø 250 x Ø 30 mm	Ø 254 x Ø 30 mm
Broj zuba	48	48
Podšavanje kuta lista pile	0° do 45° na lijevo	0° do 45° na lijevo
Visina reza 90°	78 mm	80 mm
Visina reza 45°	53 mm	55 mm
Veličina stola	645 x 530 mm	580 x 555 mm
Maksimalna kontaktna površina	865 x 795 mm	780 x 1055 mm
Težina proizvoda	34,9 kg	26,2 kg
Postolje pile	•	•
Produžetak stola	Desno / straga	Lijevo / desno / straga
Sklopivo postolje	•	-
Formatna funkcija	•	-
Polagano pokretanje	•	•
Precizni TCT list pile	1 kom	1 kom
Paralelni graničnik	•	•
Kutni graničnik	•	•
Broj artikla	43.405.39	43.405.15



4 006825 647518



4 006825 641349

STOLNE KRUŽNE PILE S POSTOLJEM



	TC-TS 254 U CLASSIC	TC-TS 2025/2 U CLASSIC
Napon	220 - 240 V ~ 50 Hz	220 - 240 V ~ 50 Hz
Snaga	2200 W S6 25%	2000 W S6 25%
Broj okretaja	4250 min ⁻¹	5000 min ⁻¹
List pile	Ø 254 x Ø 30 mm	Ø 250 x Ø 30 mm
Broj zuba	24	24
Podšavanje kuta lista pile	0° do 45° na lijevo	0° do 45° na lijevo
Visina reza 90°	80 mm	85 mm
Visina reza 45°	55 mm	65 mm
Veličina stola	580 x 555 mm	583 x 563 mm
Maksimalna kontaktna površina	580 x 855 mm	583 x 893 mm
Težina proizvoda	21,9 kg	19,2 kg
Postolje pile	•	•
Produžetak stola	Lijevo / desno	Lijevo / desno
Sklopivo postolje	-	-
Formatna funkcija	-	-
Polagano pokretanje	-	-
Precizni TCT list pile	1 kom	1 kom
Paralelni graničnik	•	•
Kutni graničnik	•	•
Broj artikla	43.405.10	43.404.90



4 006825 646320



4 006825 646474

STOLNE KRUŽNE PILE S POSTOLJEM



	TC-TS 2025/3 eco CLASSIC	TC-TS 254 eco CLASSIC
Napon	220 - 240 V ~ 50 Hz	220 - 240 V ~ 50 Hz
Snaga	2000 W S6 25%	2050 W S6 40%
Broj okretaja	5000 min ⁻¹	4250 min ⁻¹
List pile	Ø 250 x Ø 30 mm	Ø 254 x Ø 30 mm
Broj zuba	24	24
Podešavanje kuta lista pile	0° do 45° na lijevo	0° do 45° na lijevo
Visina reza 90°	85 mm	80 mm
Visina reza 45°	65 mm	55 mm
Veličina stola	583 x 563 mm	580 x 555 mm
Maksimalna kontaktna površina	583 x 563 mm	580 x 555 mm
Težina proizvoda	16,2 kg	18,6 kg
Postolje pile	•	•
Produžetak stola	-	-
Sklopivo postolje	-	-
Formatna funkcija	-	-
Polagano pokretanje	-	-
Precizni TCT list pile	1 kom	1 kom
Paralelni graničnik	•	•
Kutni graničnik	•	•
Broj artikla	43.404.95	43.405.05



4 006825 646481



4 006825 646337

STOLNA KRUŽNA PILA S POSTOLJEM



	TC-TS 315 U CLASSIC
Napon	220 - 240 V ~ 50 Hz
Snaga	2000 W S6 40%
Broj okretaja	2950 min ⁻¹
List pile	Ø 315 x Ø 30 mm
Broj zuba	40
Podešavanje kuta lista pile	0° do 45° na lijevo
Visina reza 90°	85 mm
Visina reza 45°	55 mm
Veličina stola	800 x 550 mm
Maksimalna kontaktna površina	800 x 550 mm (radni stol) + 740 x 400 mm (produžetak stola)
Težina proizvoda	52,6 kg
Postolje pile	•
Produžetak stola	Straga
Sklopivo postolje	-
Formatna funkcija	Uz opcijski klizni element
Polagano pokretanje	-
Precizni TCT list pile	1 kom
Paralelni graničnik	•
Kutni graničnik	•
Broj artikla	43.405.56



4 006825 640083

STOLNA KRUŽNA PILA

	TE-TS 254 T	NOVO
	EXPERT	
Napon	220 - 240 V ~ 50 Hz	
Snaga	2000 W S6 25%	
Broj okretaja	4700 min ⁻¹	
List pile	Ø 254 x Ø 30 mm	
Broj zuba	48	
Podšavanje kuta lista pile	0° do 45° na lijevo	
Visina reza 90°	89 mm	
Visina reza 45°	63 mm	
Veličina stola	540 x 505 mm	
Maksimalna kontaktna površina	540 x maks. 990 mm	
Težina proizvoda	17,5 kg	
Polagano pokretanje	•	
Precizni TCT list pile	1 kom	
Paralelni graničnik	•	
Kutni graničnik	•	
Broj artikla	43.404.30	



4 006825 659160

STOLNE KRUŽNE PILE

	TC-TS 210	TC-TS 200
	CLASSIC	CLASSIC
Napon	220 - 240 V ~ 50 Hz	230 - 240 V ~ 50 Hz
Snaga	1200 W S6 40%	800 W S6 15%
Broj okretaja	4800 min ⁻¹	2950 min ⁻¹
List pile	Ø 210 x Ø 30 mm	Ø 200 x Ø 16 mm
Broj zuba	24	24
Podšavanje kuta lista pile	0° do 45° na lijevo	0° do 45° na lijevo
Visina reza 90°	45 mm	45 mm
Visina reza 45°	27 mm	27 mm
Veličina stola	525 x 440 mm	505 x 373 mm
Maksimalna kontaktna površina	525 x 440 mm	505 x 373 mm
Težina proizvoda	11,3 kg	11,6 kg
Precizni TCT list pile	1 kom	1 kom
Paralelni graničnik	•	•
Kutni graničnik	•	•
Broj artikla	43.404.25	43.404.15



4 006825 647273



4 006825 647266

STOLNE BLANJE



Ilustrativna slika



	TC-SP 204/1 CLASSIC NOVO	TC-SP 204 CLASSIC
Napon	220 - 240 V ~ 50 Hz	230 - 240 V ~ 50 Hz
Snaga	1500 W	1500 W
Broj okretaja	9000 min ⁻¹	9000 min ⁻¹
Maks. radna širina	204 mm	204 mm
Maks. dubina reza	3 mm	3 mm
Maks. debljina materijala na otvoru	120 mm	120 mm
Maks. kut paralelnog graničnika	45°	45°
Priključak za usisavanje prašine	100 mm	100 mm
Težina proizvoda	27,9 kg	27,2 kg
Stol za dopremu	•	•
Odvojnivi stol	•	•
Pribor	2 oštrice za blanjanje	2 oštrice za blanjanje
Poluga za guranje radnog komada	•	•
Broj artikla	44.199.57	44.199.55



PILA ZA IZREZIVANJE



	TC-SS 406 E CLASSIC NOVO
Napon	230 V ~ 50 Hz
Snaga	120 W S6 30%
Broj uboda	400 - 1600 min ⁻¹
Visina uboda	14 mm
Dubina	406 mm
Podšavanje kuta lista pile	-2° do +47° na lijevo
Maks. visina reza 90°	50 mm
Maks. visina reza 45°	23 mm
Težina proizvoda	12,4 kg
Uređaj za držanje radnog komada	•
Funkcija puhanja	•
Adapter za spiralne rezne listove	•
Adapter za usisavanje prašine	•
List pile	2 kom
Broj artikla	43.090.47



TRAČNE PILE



Ilustrativna slika



Ilustrativna slika

	TC-SB 305 U CLASSIC	TC-SB 245 L CLASSIC	TC-SB 200/1 CLASSIC
Napon	220 - 240 V ~ 50 Hz	220 - 240 V ~ 50 Hz	220 - 240 V ~ 50 Hz
Snaga	750 W	400 W	250 W S2 15 min
Brzina lista pile	370 m/min 800 m/min	735 m/min	900 m/min
Dubina	305 mm	245 mm	200 mm
Priključak za usisavanje prašine	Ø 70 mm / Ø 100 mm	Ø 36 mm	Ø 36 mm
Podšavanje kuta lista pile	0° do 45°	0° do 45°	-2° do 45°
Visina reza 90°	170 mm	101 mm	80 mm
Visina reza 45°	75 mm	60 mm	45 mm
Težina proizvoda	64,6 kg	24,8 kg	17,4 kg
Broj brzina	2	1	1
Postolje pile	•	-	-
LED svjetlo	-	•	-
Paralelni graničnik	•	•	•
Kutni graničnik	•	•	-
Broj artikla	43.080.55	43.080.35	43.080.18



4 006825 608861



4 006825 649994



4 006825 617382



TOKARSKI STROJ ZA DRVO



TC-WW 1000/1 CLASSIC	
Napon	230 V ~ 50 Hz
Snaga	350 W
Broj okretaja 1	890 min ⁻¹
Broj okretaja 2	1260 min ⁻¹
Broj okretaja 3	1760 min ⁻¹
Broj okretaja 4	2600 min ⁻¹
Promjer radnog komada	280 mm
Duljina radnog komada	1000 mm
Težina proizvoda	22,9 kg
Pogon preko klinastog remena podesiv u 4 pozicije	•
Radna prihvatna ploča	•
Oslonac alata	•
Konjić	•
Krunasti prsten	•
Broj artikla	43.121.10



4 006825 633924

INDUSTRIJSKI USISAVAČ



TE-VE 550/2 A EXPERT NOVO	
Napon	220 - 240 V ~ 50 Hz
Snaga	550 W S1
Broj okretaja	2850 min ⁻¹
Kapacitet vreće	65 l
Kapacitet zraka	1150 m ³ /h
Podtlak	Maks. 1600 Pa
Duljina crijeva	2,5 m
Težina proizvoda	17,9 kg
Automatska utičnica za pokretanje spojenog alata	•
Ručka	•
Šasija	•
Potporna vreća za prašinu	•
Brzootpuštajuća spojnica za zamjenu vreće	•
Indukcijski motor	•
Vreća za prašinu	•
Set adaptera	5 kom
Usisni adapter	2x 36 mm na 100 mm
Broj artikla	43.041.56



4 006825 648058

USISAVAČI SUHO/MOKRO

CRIJEVO ZA TEŠKE UVJETE RADA

Usisno crijevo dužine 3,00 m fleksibilno je i istovremeno izrazito čvrsto i otporno

RUČKA ZA VOĐENJE

Transportna ručka s funkcijom kolica pojednostavljuje mobilnost. Držač kabela osigurava najvišu urednost

AUTOMATSKA UTIČNICA ZA ALAT

Automatska utičnica s maks. 1900 W i funkcijom sinkroniziranog pokretanja priključenog alata

ČVRSTA TELESKOPSKA CIJEV OD NEHRĐAJUĆEG ČELIKA

Inteligentni spojevi cijevi smanjuju turbulencije zraka i time povećavaju učinkovitost uređaja

Usisavač suho/mokro
TE-VC 2340 SACL

VIJAK ZA ODVOD VODE

Jednostavna i brza odvodnja prikupljene vode

KLASA PRAŠINE L

Usisavač klase prašine L prema Euro standardima također filtrira posebno finu prašinu (npr. prašinu od gipsa)



REGULACIJA SNAGE USISAVANJA

Snaga usisavanja može se beskonačno podešavati ovisno o zahtjevima posla

SUSTAV ČIŠĆENJA FILTERA

Integrirana tehnologija čišćenja filtera osigurava konstantno visoku snagu usisavanja



VELIKI KOTAČI I KOTAČIĆI

Uz 2 kotača i 2 kotačića, usisavač suho/mokro može se vrlo jednostavno voditi kroz radionicu, garažu ili dnevnu sobu

NOSAČ NASTAVAKA

Nastavci se mogu pospremiti izravno na usisavač i stoga su uvijek spremni za upotrebu

USISAVAČI SUHO/MOKRO



	TE-VC 2350 SACL EXPERT	TE-VC 2340 SACL EXPERT
Napon	220 - 240 V ~ 50/60 Hz	220 - 240 V ~ 50/60 Hz
Snaga	1600 W S1	1500 W S1
Usisna snaga	230 mbar	225 mbara
Spremnik	Nehrđajući čelik, 50 l	Nehrđajući čelik, 40 l
Usisno crijevo duljina / promjer	300 cm / 36 mm	300 cm / 36 mm
Duljina kabela	600 cm	600 cm
Razina buke	74 dB(A)	72 dB(A)
Težina proizvoda	13,1 kg	10,1 kg
Držač kabela	•	•
Priključak za puhanje	•	•
Nosači nastavaka	•	•
Vijak za ispuštanje vode	•	•
Automatska utičnica	•	•
ECO Power motor	•	•
Tehnologija čišćenja filtera	•	•
Crijevo za teške uvjete rada	•	•
Klasa prašine L	•	•
Regulacija snage usisavanja	-	•
Usisna cijev	Teleskopska, nehrđajući čelik	Teleskopska, nehrđajući čelik
Nastavci	Kombinirani, uski, usisna četka (po 1x)	Kombinirani, uski, usisna četka (po 1x)
Filter	Spužvasti, HEPA, vrećica za prašinu, dual filter vrećica (po 1x)	Spužvasti, HEPA (po 1x)
Broj artikla	23.424.75	23.424.70



4 006825 657494



4 006825 658347



USISAVAČI SUHO/MOKRO



	TE-VC 2230 SACL EXPERT	TE-VC 2025 SACL EXPERT
Napon	220 - 240 V ~ 50/60 Hz	220 - 240 V ~ 50/60 Hz
Snaga	1400 W S1	1200 W S1
Usisna snaga	220 mbara	200 mbara
Spremnik	Nehrđajući čelik, 30 l	Nehrđajući čelik, 25 l
Usisno crijevo duljina / promjer	300 cm / 36 mm	300 cm / 36 mm
Duljina kabela	500 cm	500 cm
Razina buke	72 dB(A)	72 dB(A)
Težina proizvoda	9,2 kg	6,9 kg
Držač kabela	•	•
Priključak za puhanje	•	•
Nosači nastavaka	•	•
Vijak za ispuštanje vode	•	•
Automatska utičnica	•	•
ECO Power motor	•	•
Tehnologija čišćenja filtera	•	•
Crijevo za teške uvjete rada	•	•
Klasa prašine L	•	•
Regulacija snage usisavanja	•	•
Usisna cijev	Teleskopska, nehrđajući čelik	Teleskopska, nehrđajući čelik
Nastavci	Kombinirani, uski, usisna četka (po 1x)	Kombinirani, uski, usisna četka (po 1x)
Filter	Spužvasti, HEPA (po 1x)	Spužvasti, HEPA (po 1x)
Broj artikla	23.424.65	23.424.60



USISAVAČI SUHO/MOKRO



	TE-VC 2230 SA EXPERT	TC-VC 1930 SA CLASSIC
Napon	230 V ~ 50 Hz	220 - 240 V ~ 50/60 Hz
Snaga	1150 W S1	1500 W S1
Usisna snaga	220 mbara	190 mbara
Spremnik	Nehrđajući čelik, 30 l	Nehrđajući čelik, 30 l
Usisno crijevo duljina / promjer	300 cm / 36 mm	250 cm / 36 mm
Duljina kabela	500 cm	300 cm
Razina buke	74 dB(A)	78 dB(A)
Težina proizvoda	10,2 kg	5,3 kg
Držač kabela	•	•
Priključak za puhanje	•	•
Nosači nastavaka	•	•
Vijak za ispuštanje vode	•	•
Automatska utičnica	•	•
ECO Power motor	•	-
Usisna cijev	Teleskopska, nehrđajući čelik	2 dijela, plastika
Nastavci	Kombinirani, uski, usisna četka (po 1x)	Kombinirani, uski (po 1x)
Filter	Spužvasti, dugotrajni, vrećica za prašinu (po 1x)	Spužvasti, dugotrajni (po 1x)
Broj artikla	23.423.63	23.421.90



USISAVAČ SUHO/MOKRO



	TC-VC 1820 SA CLASSIC
Napon	220 - 240 V ~ 50/60 Hz
Snaga	1250 W S1
Usisna snaga	180 mbara
Spremnik	Nehrđajući čelik, 20 l
Usisno crijevo duljina / promjer	150 cm / 36 mm
Duljina kabela	250 cm
Razina buke	78 dB(A)
Težina proizvoda	4,0 kg
Držač kabela	•
Priključak za puhanje	•
Nosači nastavaka	•
Vijak za ispuštanje vode	-
Automatska utičnica	•
ECO Power motor	-
Usisna cijev	3 dijela, plastika
Nastavci	Kombinirani, uski (po 1x)
Filter	Spužvasti filter, filter vrećica, vrećica za prašinu (po 1x)
Broj artikla	23.424.25



USISAVAČI SUHO/MOKRO



	TC-VC 1820 S CLASSIC	TC-VC 1815 S CLASSIC
Napon	220 - 240 V ~ 50/60 Hz	220 - 240 V ~ 50 Hz
Snaga	1250 W S1	1250 W S1
Usisna snaga	180 mbara	180 mbara
Spremnik	Nehrđajući čelik, 20 l	Nehrđajući čelik, 15 l
Usisno crijevo duljina / promjer	150 cm / 36 mm	150 cm / 36 mm
Duljina kabela	300 cm	250 cm
Razina buke	78 dB(A)	79 dB(A)
Težina proizvoda	3,5 kg	3,0 kg
Držač kabela	•	•
Priključak za puhanje	•	•
Nosači nastavaka	•	•
Vijak za ispuštanje vode	-	-
Automatska utičnica	-	-
ECO Power motor	-	-
Usisna cijev	3 dijela, plastika	3 dijela, plastika
Nastavci	Kombinirani, uski (po 1x)	Kombinirani, uski (po 1x)
Filter	Spužvasti filter, filter vrećica, vrećica za prašinu (po 1x)	Spužvasti filter, filter vrećica, vrećica za prašinu (po 1x)
Broj artikla	23.421.67	23.423.90



USISAVAČ SUHO/MOKRO

INCL.
NUMEROUS
ACCESSORIES



	TC-VC 1812 S CLASSIC
Napon	220 - 240 V ~ 50 Hz
Snaga	1250 W S1
Usisna snaga	180 mbara
Spremnik	Nehrđajući čelik, 12 l
Usisno crijevo duljina / promjer	150 cm / 36 mm
Duljina kabela	250 cm
Razina buke	78 dB(A)
Težina proizvoda	2,9 kg
Držač kabela	•
Priključak za puhanje	•
Nosači nastavaka	•
Vijak za ispuštanje vode	-
Automatska utičnica	-
ECO Power motor	-
Usisna cijev	3 dijela, plastika
Nastavci	Kombinirani, uski (po 1x)
Filter	Spužvasti filter, filter vrećica, vrećica za prašinu (po 1x)
Broj artikla	23.423.70



USISAVAČI SUHO/MOKRO

INCL.
NUMEROUS
ACCESSORIES



	TC-VC 1825 CLASSIC
Napon	220 - 240 V ~ 50/60 Hz
Snaga	1250 W S1
Usisna snaga	180 mbara
Spremnik	Plastika, 25 l
Usisno crijevo duljina / promjer	250 cm / 36 mm
Duljina kabela	250 cm
Razina buke	75 dB(A)
Težina proizvoda	4,3 kg
Držač kabela	•
Priključak za puhanje	•
Nosači nastavaka	•
Vijak za ispuštanje vode	-
Automatska utičnica	-
ECO Power motor	-
Usisna cijev	2 dijela, plastika
Nastavci	Kombinirani, uski (po 1x)
Filter	Spužvasti, dugotrajni, vrećica za prašinu (po 1x)
Broj artikla	23.424.30



	TC-VC 1815 CLASSIC
Napon	220 - 240 V ~ 50/60 Hz
Snaga	1250 W S1
Usisna snaga	180 mbara
Spremnik	Plastika, 15 l
Usisno crijevo duljina / promjer	150 cm / 36 mm
Duljina kabela	250 cm
Razina buke	78 dB(A)
Težina proizvoda	3,6 kg
Držač kabela	•
Priključak za puhanje	•
Nosači nastavaka	•
Vijak za ispuštanje vode	-
Automatska utičnica	-
ECO Power motor	-
Usisna cijev	3 dijela, plastika
Nastavci	Kombinirani, uski (po 1x)
Filter	Spužvasti filter, filter vrećica, vrećica za prašinu (po 1x)
Broj artikla	23.402.90



USISAVAČI PEPELA



	TC-AV 1720 DW CLASSIC	TC-AV 1718 D CLASSIC
Napon	220 - 240 V ~ 50/60 Hz	220 - 240 V ~ 50/60 Hz
Snaga	1250 W S1	1200 W S1
Usisna snaga	175 mbara	170 mbara
Spremnik	Nehrđajući čelik, 20 l	Nehrđajući čelik, 18 l
Usisno crijevo duljina / promjer	120 cm / 36 mm	100 cm / 36 mm
Duljina kabela	200 cm	200 cm
Razina buke	82 dB(A)	82 dB(A)
Težina proizvoda	4,1 kg	3,5 kg
Ručka za nošenje	•	•
Kotači	•	-
Fini filter	•	•
Predfilter	•	•
Broj artikla	23.516.66	23.516.61



VISOKOTLAČNI PERAČI



	TE-HP 170 EXPERT	TE-HP 140 EXPERT
Napon	220 - 240 V ~ 50 Hz	220 - 240 V ~ 50 Hz
Snaga	2300 W	1900 W
Maks. radni tlak	170 bara	140 bara
Maks. brzina protoka	440 l/h	420 l/h
Duljina crijeva	1000 cm	500 cm
Težina proizvoda	10,9 kg	10,8 kg
Ručka za nošenje	•	•
Prostor za odlaganje pribora	•	•
Teleskopska ručka	•	•
Kotači	•	•
Sistem za namatanje crijeva	•	•
Integrirani spremnik za deterdžent	•	•
Šiljasta i široka mlaznica	Profi	Profi
Mlaznica za prijavštinu	Profi	Profi
Spremnik za raspršivanje	Profi	Profi
Nastavak za čišćenje terase	Profi	Standard
Četka za čišćenje	Profi	Standard
Priključak crijeva s filtrom	•	•
Broj artikla	41.407.70	41.407.60



4 006825 646429



4 006825 646412

VISOKOTLAČNI PERAČI



	TC-HP 130 CLASSIC	TC-HP 90 CLASSIC
Napon	220 - 240 V ~ 50 Hz	220 - 240 V ~ 50 Hz
Snaga	1500 W	1200 W
Maks. radni tlak	130 bara	90 bara
Maks. brzina protoka	390 l/h	372 l/h
Duljina crijeva	500 cm	300 cm
Težina proizvoda	5,1 kg	4,9 kg
Ručka za nošenje	•	•
Prostor za odlaganje pribora	•	•
Teleskopska ručka	-	-
Kotači	•	-
Sistem za namatanje crijeva	-	-
Integrirani spremnik za deterdžent	-	-
Šiljasta i široka mlaznica	Standard	Standard
Mlaznica za prijavštinu	Standard	-
Spremnik za raspršivanje	Standard	-
Nastavak za čišćenje terase	-	-
Četka za čišćenje	Standard	-
Priključak crijeva s filtrom	•	•
Broj artikla	41.407.50	41.407.40



4 006825 646399



4 006825 649857

TIHI KOMPRESORI

TIHI KOMPRESOR

Zahvaljujući tihoj tehnologiji ovaj je kompresor mnogo tiši od klasičnih kompresora, bez ikakvih kompromisa na račun učinkovitosti



SPREMNIK

Spremnik od 24 l nudi dovoljne količine zraka za korištenje mnogih pneumatskih alata

OKOMITI DIZAJN

Okomiti dizajn spremnika kompresora omogućuje skladištenje uz uštedu prostora

Tihi kompresor
TE-AC 24 Silent

MANOMETAR S BRZOTPUŠTAJUĆOM SPOJNICOM

Dostupni su manometar i brza spojnica za regulirani radni tlak i veliki manometar za neregulirani tlak u spremniku



10 GODINA JAMSTVA

Odvodni vijak i visoka kvaliteta jamče dugi vijek trajanja - 10 godina jamstva protiv unutarnje korozije spremnika

SIGURAN STACIONARNI POLOŽAJ

Noge za prigušivanje vibracija osiguravaju sigurno i stabilno korištenje

TIHI KOMPRESORI



	TE-AC 50 Silent EXPERT PLUS	TE-AC 24 Silent EXPERT PLUS
Napon	220 - 240 V ~ 50 Hz	220 - 240 V ~ 50 Hz
Snaga	1500 W S1	750 W S1
Usisna snaga	270 l/min	135 l/min
Izlazna snaga na 0 4 7 bara	190 l/min 120 l/min 90 l/min	100 l/min 73 l/min 55 l/min
Kapacitet spremnika	50 l	24 l
Maks. radni tlak	8 bara	8 bara
Broj cilindara	4	2
Razina buke (LpA)	54 dB(A)	57 dB(A)
Težina proizvoda	42,6 kg	22,2 kg
Tiha tehnologija	•	•
Bezuljni motor	•	•
Regulator tlaka	•	•
Broj artikla	40.206.20	40.206.10



4 006825 650679



4 006825 640892

TIHI KOMPRESOR



	TE-AC 6 Silent EXPERT PLUS
Napon	220 - 240 V ~ 50 Hz
Snaga	550 W S1
Usisna snaga	110 l/min
Izlazna snaga na 0 4 7 bara	75 l/min 50 l/min 37 l/min
Kapacitet spremnika	6 l
Maks. radni tlak	8 bara
Broj cilindara	2
Razina buke (LpA)	57 dB(A)
Težina proizvoda	14,7 kg
Tiha tehnologija	•
Bezuljni motor	•
Regulator tlaka	•
Broj artikla	40.206.00



4 006825 640885

KOMPRESOR S POGONOM NA REMEN

SUPER AIR
+25%
POWER 10 bar



	TE-AC 430/90/10 EXPERT
Napon	220 - 240 V ~ 50 Hz
Snaga	3000 W S1
Usisna snaga	430 l/min
Izlazna snaga na 0 4 7 bara	230 l/min 210 l/min 200 l/min
Kapacitet spremnika	90 l
Maks. radni tlak	10 bara
Broj cilindara	2
Razina buke	94 dB(A)
Težina proizvoda	68,4 kg
Dvostruka kompresorska jedinica	•
Pogonjen remenom	•
Regulator tlaka	•
Broj artikla	40.108.00



4 006825 642339

KOMPRESORI (ULJNO PODMAZIVANJE)

oil
LONG-LIFE
MOTOR



	TC-AC 420/50/10 V CLASSIC	TC-AC 270/50/8 CLASSIC NOVO
Napon	220 - 240 V ~ 50 Hz	220 - 240 V ~ 50 Hz
Snaga	2200 W S1	1800 W S1
Usisna snaga	420 l/min	270 l/min
Izlazna snaga na 0 4 7 bara	245 l/min 200 l/min 150 l/min	140 l/min 125 l/min 100 l/min
Kapacitet spremnika	50 l	50 l
Maks. radni tlak	10 bara	8 bara
Broj cilindara	2	1
Razina buke	97 dB(A)	97 dB(A)
Težina proizvoda	41,8 kg	30,1 kg
Dvostruka kompresorska jedinica	•	-
Regulator tlaka	•	•
Broj artikla	40.104.95	40.073.60



4 006825 638264



4 006825 665628

KOMPRESORI (ULJNO PODMAZIVANJE)



	TE-AC 270/24/10 EXPERT	TE-AC 230/24/8 EXPERT
Napon	230 V ~ 50 Hz	230 V ~ 50 Hz
Snaga	1800 W S1	1500 W S1
Usisna snaga	270 l/min	230 l/min
Izlazna snaga na 0 4 7 bara	140 l/min 127 l/min 100 l/min	132 l/min 102 l/min 83 l/min
Kapacitet spremnika	24 l	24 l
Maks. radni tlak	10 bara	8 bara
Broj cilindara	1	1
Razina buke	94 dB(A)	94 dB(A)
Težina proizvoda	27,0 kg	23,0 kg
Dvostruka kompresorska jedinica	-	-
Regulator tlaka	•	•
Broj artikla	40.104.50	40.104.60



4 006825 594461



4 006825 594478

KOMPRESORI (ULJNO PODMAZIVANJE)



	TC-AC 190/50/8 CLASSIC	TC-AC 190/24/8 CLASSIC
Napon	220 - 240 V ~ 50 Hz	220 - 240 V ~ 50 Hz
Snaga	1500 W S2 15 min	1500 W S2 15 min
Usisna snaga	165 l/min	165 l/min
Izlazna snaga na 0 4 7 bara	110 l/min 75 l/min 55 l/min	110 l/min 75 l/min 55 l/min
Kapacitet spremnika	50 l	24 l
Maks. radni tlak	8 bara	8 bara
Broj cilindara	1	1
Razina buke	97 dB(A)	97 dB(A)
Težina proizvoda	26,3 kg	20,8 kg
Dvostruka kompresorska jedinica	-	-
Regulator tlaka	•	•
Broj artikla	40.073.32	40.073.25



4 006825 651720



4 006825 610635

KOMPRESORI (BEZULJNI)



	TC-AC 240/50/10 OF CLASSIC	TC-AC 200/24/8 OF CLASSIC
Napon	230 V ~ 50 Hz	220 - 240 V ~ 50 Hz
Snaga	1500 W S3 25%	1200 W S1
Usisna snaga	240 l/min	180 l/min
Izlazna snaga na 0 4 7 bara	173 l/min 107 l/min 76 l/min	110 l/min 70 l/min 45 l/min
Kapacitet spremnika	50 l	24 l
Maks. radni tlak	10 bara	8 bara
Broj cilindara	1	1
Razina buke	97 dB(A)	97 dB(A)
Težina proizvoda	22,2 kg	16,0 kg
Namotavanje kabela	-	-
Bezuljni motor	•	•
Skladištenje pribora	•	-
Regulator tlaka	•	•
Crijevo za komprimirani zrak	-	-
Ispušni adapter	-	-
Nastavak za pumpanje guma s manometrom	-	-
Set adaptera	-	-
Broj artikla	40.103.93	40.205.90



4 006825 597295



4 006825 640496

MOBILNI KOMPRESORI (BEZULJNI)



	TC-AC 190/6/8 OF Set CLASSIC	TC-AC 190/6/8 OF CLASSIC NOVO	TC-AC 190 OF Set CLASSIC
Napon	220 - 240 V ~ 50 Hz	220 - 240 V ~ 50 Hz	220 - 240 V ~ 50 Hz
Snaga	1200 W S1	1200 W S1	1100 W S3 15%
Usisna snaga	190 l/min	190 l/min	190 l/min
Izlazna snaga na 0 4 7 bara	130 l/min 77 l/min 55 l/min	130 l/min 77 l/min 55 l/min	165 l/min 83 l/min 55 l/min
Kapacitet spremnika	6 l	6 l	Bez tlačne posude
Maks. radni tlak	8 bara	8 bara	8 bara
Broj cilindara	1	1	1
Razina buke	97 dB(A)	97 dB(A)	97 dB(A)
Težina proizvoda	8,8 kg	8,8 kg	5,0 kg
Namotavanje kabela	•	•	•
Bezuljni motor	•	•	•
Skladištenje pribora	•	•	•
Regulator tlaka	•	•	-
Crijevo za komprimirani zrak	•	-	•
Ispušni adapter	•	-	•
Nastavak za pumpanje guma s manometrom	•	-	•
Set adaptera	•	-	•
Broj artikla	40.206.50	40.206.55	40.206.60



4 006825 641578



4 006825 669190



4 006825 642346

PNEUMATSKI ALATI ZA KOMPRESORE



	TC-PN 50 CLASSIC
Vrsta alata	Pneumatska klamerica
Radni tlak	Maks. 8,3 bara
Zakretni moment	-
Pribor	3x 500 spajalica, 2x 1000 čavlića
Pakiranje	Kovčeg
Broj artikla	41.377.90



4 006825 641387



	TC-PW 610 Compact CLASSIC
Vrsta alata	Pneumatski udarni odvijač
Radni tlak	Maks. 8,0 bara
Zakretni moment	610 Nm
Pribor	3 nastavka s plastičnom čahurom, 10 m trake za brtvljenje navoja
Pakiranje	Kovčeg
Broj artikla	41.389.65



4 006825 660630



	TC-PW 610 CLASSIC
Vrsta alata	Pneumatski udarni odvijač
Radni tlak	Maks. 6,3 bara
Zakretni moment	610 Nm
Pribor	10 nastavaka, 1 produžetak
Pakiranje	Karton
Broj artikla	41.389.60



4 006825 639971



	TC-PW 340 CLASSIC
Vrsta alata	Pneumatski udarni odvijač
Radni tlak	Maks. 6,3 bara
Zakretni moment	340 Nm
Pribor	8 nastavaka
Pakiranje	Karton
Broj artikla	41.389.50



4 006825 639995



	TC-PP 220 CLASSIC
Vrsta alata	Pneumatska brusilica
Radni tlak	Maks. 6,3 bara
Zakretni moment	-
Pribor	10 brusnih nastavaka
Pakiranje	Kovčeg
Broj artikla	41.385.40



4 006825 641400

PNEUMATSKI ALATI ZA KOMPRESORE



	TC-PC 45 CLASSIC	TC-PC 45 Set CLASSIC
Vrsta alata	Pneumatski čekić	Pneumatski čekić u setu
Radni tlak	Maks. 6,3 bara	Maks. 6,3 bara
Zakretni moment	-	-
Pribor	Set dlijeta, 4 kom	Set dlijeta, 4 kom, 1 igličasti nastavak za skidanje hrđe
Pakiranje	Karton	Karton
Broj artikla	41.390.40	41.390.45



	TC-PR 68 CLASSIC	TC-PE 150 CLASSIC
Vrsta alata	Pneumatski nasadni odvijač	Pneumatska ekscentrična brusilica
Radni tlak	Maks. 6,3 bara	Maks. 6,3 bara
Zakretni moment	68 Nm	-
Pribor	7 ključeva, 1 adapter, 1 univerzalni zglob	6 brusnih papira (2x P80, 2x P100, 2x P120)
Pakiranje	Kovčeg	Karton
Broj artikla	41.391.80	41.333.30



	TC-PH 150 CLASSIC
Vrsta alata	Pneumatsko automatsko bubanj crijevo
Radni tlak	Maks. 16 bara
Duljina crijeva	15 m
Duljina priključnog crijeva	1,5 m
Unutarnji promjer crijeva	9 mm
Pakiranje	Karton
Broj artikla	41.380.05



	Kovčeg za pneumatske alate ACCESSORY NOVO
Pogodan za	Pneumatska klamera, Pneumatski udarni odvijač, Pneumatska brusilica, Pneumatski čekić, Pneumatski nasadni odvijač
Broj artikla	45.400.40



PRIBOR ZA KOMPRESORE



	Pištolj za ispuhivanje sa 4 mlaznice ACCESSORY	Pištolj za ispuhivanje s 500 mm mlaznicom ACCESSORY	2 smjerni pištolj za ispuhivanje ACCESSORY NOVO
Radni tlak	2 - 8 bara	2 - 8 bara	2 - 8 bara
Pakiranje	Karton	Blister	Karton
Broj artikla	41.327.62	41.327.63	41.332.10



	Pištolj za ispuhivanje, dugi ACCESSORY	Pištolj za ispuhivanje, kratki ACCESSORY	Pištolj za ispuhivanje u setu ACCESSORY
Radni tlak	2 - 8 bara	2 - 8 bara	2 - 8 bara
Pakiranje	Karton	Karton	Karton
Broj artikla	41.331.02	41.331.00	41.327.59



	Nastavak za pumpanje guma s digitalnim manometrom ACCESSORY	Profi nastavak za pumpanje guma s manometrom ACCESSORY	Nastavak za pumpanje guma s manometrom ACCESSORY
Radni tlak	0 - 13 bara	0 - 8 bara	0 - 8 bara
Pakiranje	Karton	Karton	Karton
Broj artikla	41.331.15	41.331.10	41.370.00



PRIBOR ZA KOMPRESORE



	Profi pištolj za boju s plastičnom posudom, 0,6 l ACCESSORY	Pištolj za boju s plastičnom posudom, 0,6 l ACCESSORY	Pištolj za boju s metalnom posudom, 1 l ACCESSORY
Vrsta posude	Protočna posuda	Protočna posuda	Usisna posuda
Kapacitet spremnika	600 ml	600 ml	1000 ml
Radni tlak	3 - 3,5 bara	3 - 4 bara	3 - 4 bara
Pakiranje	Karton	Karton	Karton
Broj artikla	41.330.30	41.330.00	41.329.00



	Pištolj za raspršivanje ACCESSORY	Pištolj za pjeskarenje s metalnom posudom ACCESSORY	Usisni pištolj za pjeskarenje ACCESSORY	Pištolj za podnu zaštitu ACCESSORY
Vrsta posude	Usisna posuda	Usisna posuda	-	-
Kapacitet spremnika	900 ml	1000 ml	-	-
Radni tlak	3 - 8 bara	3 - 8 bara	0 - 7 bara	3 - 8 bara
Pakiranje	Karton	Karton	Karton	Karton
Broj artikla	41.332.00	41.333.00	41.334.20	41.335.01



	Set za kompresor, 13/1 ACCESSORY	Set za kompresor, 10/1 ACCESSORY	Profi set za kompresor, 5/1 ACCESSORY	Set za kompresor, 3/1 ACCESSORY
Opseg isporuke	13 kom	10 kom	5 kom	3 kom
Pakiranje	Karton	Karton	Karton	Karton
Broj artikla	41.327.76	40.205.77	41.327.20	41.327.41



STOLNE BRUSILICE



	TC-BG 200 L CLASSIC	TC-BG 150 B CLASSIC NOVO
Napon	220 - 240 V ~ 50 Hz	220 - 240 V ~ 50 Hz
Snaga	400 W S2 30 min	350 W S6 15 %
Broj okretaja	2980 min ⁻¹	2980 min ⁻¹
Promjer brusne ploče Ø	200 mm	150 mm
Provrtna brusne ploče Ø	16 mm	12,7 mm
Debljina brusne ploče	25 mm	20 mm
Granulacija	36 60	36
Težina proizvoda	11,7 kg	8,5 kg
Regulacija brzine	-	-
LED radna svjetiljka	•	-
Potporna za radni komad podesiva bez dodatnog alata	•	•
Zaštita od iskrenja podesiva bez dodatnog alata	•	•
Fleksibilna osovina	-	-
Žičana četka	-	•
Set pribora	-	-
Broj artikla	44.126.33	44.126.34



4 006825 649918



4 006825 667110

STOLNE BRUSILICE



	TC-BG 150 CLASSIC	TC-XG 75 Kit CLASSIC
Napon	220 - 240 V ~ 50 Hz	220 - 240 V ~ 50 Hz
Snaga	150 W S2 30 min	150 W S2 5 min
Broj okretaja	2980 min ⁻¹	Podesivo do 9900 min ⁻¹
Promjer brusne ploče Ø	150 mm	75 mm
Provrtna brusne ploče Ø	12,7 mm	10 mm
Debljina brusne ploče	16 mm	20 mm
Granulacija	36 60	120 400
Težina proizvoda	6,0 kg	1,8 kg
Regulacija brzine	-	•
LED radna svjetiljka	-	-
Potporna za radni komad podesiva bez dodatnog alata	•	•
Zaštita od iskrenja podesiva bez dodatnog alata	•	•
Fleksibilna osovina	-	•
Žičana četka	-	-
Set pribora	-	•
Broj artikla	44.126.32	44.125.59



4 006825 649888



4 006825 649932

STOLNA BRUSILICA MOKRO



TC-WG 200 CLASSIC	
Napon	220 - 240 V ~ 50 Hz
Snaga	125 W S1
Broj okretaja	110 min ⁻¹
Promjer brusne ploče Ø	200 mm
Provt brusne ploče Ø	12,7 mm
Debljina brusne ploče	40 mm
Promjer kožne brusne ploče Ø	180 mm
Debljina kožne brusne ploče	30 mm
Granulacija	220
Težina proizvoda	7,3 kg
Brusna ploča (mokra) male brzine	•
Kožna brusna ploča	•
Brusna ploča (suha) velike brzine	-
Spremnik za vodu otporan na koroziju	•
Ručka za nošenje	•
Univerzalna potpora za radni komad	•
Univerzalni uređaj za brušenje raznih alata	•
Brusni kamen	•
Mjerač kutova	•
Broj artikla	44.180.08



4 006825 649963

STOLNA BRUSILICA SUHO/MOKRO



TC-WD 200/150 CLASSIC	
Napon	220 - 240 V ~ 50 Hz
Snaga	250 W S2 30 min
Broj okretaja	2980 min ⁻¹ 134 min ⁻¹
Promjer brusne ploče Ø	150 mm 200 mm
Provt brusne ploče Ø	12,7 mm 20 mm
Debljina brusne ploče	20 mm 40 mm
Granulacija	36 200
Težina proizvoda	9,1 kg
Brusna ploča (mokra) male brzine	•
Kožna brusna ploča	-
Brusna ploča (suha) velike brzine	•
Spremnik za vodu otporan na koroziju	•
Broj artikla	44.172.42



4 006825 649949

STOLNE TRAČNE BRUSILICE



	TC-US 380 CLASSIC	TC-US 350 CLASSIC
Napon	230 - 240 V ~ 50 Hz	220 - 240 V ~ 50 Hz
Snaga	380 W S6 20%	350 W S2 30 min
Broj okretaja	1500 min ⁻¹	2980 min ⁻¹
Brzina brusne trake	292 m/min	900 m/min
Brusna ploča	Ø 150 mm	Ø 150 x Ø 12,7 x 20 mm
Brusna traka	100 x 914 mm	50 x 686 mm
Opseg okretanja	-60° do 60°	-
Granulacija	80 80	36 80
Težina proizvoda	13,3 kg	8,2 kg
Štitnik od iskrenja	-	•
Gumene noge za niske vibracije	•	•
Podesive potpore za radni komad	•	•
Adapter za usisavanje prašine	•	-
Nagibni aluminijski stol	•	-
Poprečni graničnik	•	-
Brusna traka	•	•
Brusna ploča od korunda	-	•
Brusna ploča s uključenim brusnim papirom	•	-
Broj artikla	44.192.57	44.661.54



4 006825 649987



4 006825 649956

PREKLOPNA PILA ZA METAL



	TC-MC 355/1 CLASSIC	NOVO
Napon	220 - 240 V ~ 50 Hz	
Snaga	2200 W	
Rezna ploča	Ø 355 x Ø 25,4 x 2,8 mm	
Broj okretaja	4200 min ⁻¹	
Podešavanje kuta lista pile	0° do +45°	
Maks. širina reza na 90°, četvrtasti profil	110 x 110 mm	
Maks. širina reza na 90°, okrugli profil	Ø 125 mm	
Maks. raspon stezanja	250 mm	
Veličina stola	470 x 280 mm	
Težina proizvoda	13,9 kg	
Polagano pokretanje	•	
Graničnik visine	•	
Zaključavanje rezne ploče	•	
Uređaj za stezanje s brzim otpuštanjem	•	
Transportna stezaljka	•	
Broj artikla	45.031.39	



4 006825 662719

STUPNE BUŠILICE



	TE-BD 750 E EXPERT	TE-BD 550 E EXPERT
Napon	220 - 240 V ~ 50 Hz	230 - 240 V ~ 50 Hz
Snaga	750 W S2 15 min	550 W S2 15 min
Broj okretaja	450 - 2500 min ⁻¹	450 - 2500 min ⁻¹
Broj postavki brzine	Beskonačno podesivo	Beskonačno podesivo
Maks. dubina bušenja	80 mm	60 mm
Razmak između svrdla i stupa	152 mm	115 mm
Promjer svrdla	1 - 16 mm	0 - 13 mm
Zakretanje radnog stola	-45° do +45°	-45° do +45°
Dimenzija radnog stola	243 x 243 mm	170 x 170 mm
Dimenzija postolja	304 x 456 mm	215 x 340 mm
Visina bušilice	955 mm	770 mm
Težina proizvoda	44,4 kg	21,4 kg
LED osvetljenje	•	-
LCD zaslon	•	•
Brzostezna glava	•	•
Produljenje radnog stola	•	-
Prihvat stezne glave	B16	B16
MK2 prihvat	•	-
Broj artikla	42.507.15	42.506.90



4 006825 617771



4 006825 634778

STUPNE BUŠILICE



	TC-BD 630/1 CLASSIC	TC-BD 500 CLASSIC
Napon	220 - 240 V ~ 50 Hz	230 - 240 V ~ 50 Hz
Snaga	630 W S2 15 min	500 W S6 40%
Broj okretaja	200 - 2450 min ⁻¹	300 - 2410 min ⁻¹
Broj postavki brzine	12 postavki	9 postavki
Maks. dubina bušenja	60 mm	50 mm
Dubina	126 mm	115 mm
Promjer svrdla	1,5 - 16 mm	1,5 - 13 mm
Zakretanje radnog stola	-45° do +45°	-45° do +45°
Dimenzija radnog stola	200 x 195 mm	170 x 170 mm
Dimenzija postolja	230 x 350 mm	200 x 315 mm
Visina bušilice	850 mm	620 mm
Težina proizvoda	32,5 kg	13,9 kg
LED osvetljenje	-	-
LCD zaslon	-	-
Brzostezna glava	-	-
Produljenje radnog stola	-	-
Prihvat stezne glave	B16	B16
MK2 prihvat	•	-
Broj artikla	45.205.97	45.205.93



4 006825 668476



4 006825 649925

STUPNA BUŠILICA



	TC-BD 450 CLASSIC
Napon	230 - 240 V ~ 50 Hz
Snaga	450 W S6 20%
Broj okretaja	600 - 2650 min ⁻¹
Broj postavki brzine	5 postavki
Maks. dubina bušenja	50 mm
Dubina	104 mm
Promjer svrdla	1,5 - 13 mm
Zakretanje radnog stola	-45° do +45°
Dimenzija radnog stola	160 x 160 mm
Dimenzija postolja	190 x 295 mm
Visina bušilice	592 mm
Težina proizvoda	13,0 kg
LED osvjetljenje	-
LCD zaslon	-
Brzostezna glava	-
Produljenje radnog stola	-
Prihvat stezne glave	B16
MK2 prihvat	-
Broj artikla	45.205.92



STROJEVI ZA REZANJE KAMENA



	TE-SC 920 L EXPERT	TE-SC 570 L EXPERT
Napon	230 V ~ 50 Hz	230 V ~ 50 Hz
Snaga	2200 W S2 20 min	1500 W S2 20 min
Broj okretaja	3000 min ⁻¹	3000 min ⁻¹
Visina reza 90° 45°	70 mm 55 mm	60 mm 48 mm
Duljina reza	920 mm	570 mm
Rezna ploča	Ø 300 x Ø 25,4 mm	Ø 250 x Ø 25,4 mm
Podlašavanje kuta lista pile	0° do 45° na lijevo	0° do 45° na lijevo
Težina proizvoda	53,5 kg	42,6 kg
Kadica za vodu	•	•
Laser	•	•
Broj artikla	43.014.32	43.014.44



4 006825 541199



4 006825 541243



STROJEVI ZA REZANJE PLOČICA



	TE-TC 920 UL EXPERT	TE-TC 620/1 U EXPERT
Napon	220 - 240 V ~ 50 Hz	220 - 240 V ~ 50 Hz
Snaga	900 W S6 20%	900 W S6 20%
Broj okretaja	2950 min ⁻¹	2950 min ⁻¹
Visina reza 90° 45°	36 mm 29 mm	30 mm 25 mm
Duljina reza	920 mm	620 mm
Rezna ploča	Ø 200 x Ø 25,4 mm	Ø 200 x Ø 25,4 mm
Podšavanje kuta lista pile	0° do 45° na lijevo	0° do 45° na lijevo
Težina proizvoda	42,7 kg	34,4 kg
Kadica za vodu	•	•
Laser	•	-
Transportni kotači	•	•
Paralelni graničnik	•	•
Kutni graničnik	•	•
Broj artikla	43.012.20	43.012.95



4 006825 614367



4 006825 587067

STROJ ZA REZANJE PLOČICA



	TC-TC 800 CLASSIC
Napon	220 - 240 V ~ 50 Hz
Snaga	800 W S2 10 min
Broj okretaja	2950 min ⁻¹
Visina reza 90° 45°	34 mm 14 mm
Duljina reza	-
Rezna ploča	Ø 180 x Ø 25,4 mm
Podšavanje kuta lista pile	0° do 45° na lijevo
Težina proizvoda	8,6 kg
Kadica za vodu	•
Laser	-
Transportni kotači	-
Paralelni graničnik	•
Kutni graničnik	•
Broj artikla	43.011.85



4 006825 624687

ELEKTRIČNE DIZALICE



	TC-EH 1000 CLASSIC	TC-EH 600 CLASSIC
Napon	220 - 240 V ~ 50 Hz	220 - 240 V ~ 50 Hz
Snaga	1600 W S3 25%	1050 W S3 20%
Visina podizanja bez kolotura	18 m	18 m
Visina podizanja s koloturom	9 m	9 m
Nosivost bez kolotura	500 kg	300 kg
Nosivost s koloturom	999 kg	600 kg
Brzina bez kolotura	8 m/min	8 m/min
Brzina s koloturom	4 m/min	4 m/min
Težina proizvoda	32,0 kg	16,8 kg
Termalni prekidač	•	•
Automatska kočnica za osiguranje tereta	•	•
Automatsko isključivanje kod preopterećenja	•	•
Nesavrtljivi žičani kabel	•	•
Kontrolni prekidač s hitnim zaustavljanjem	•	•
Kolotur s teretnom kukom	•	•
Stezaljke za pričvršćivanje	•	•
Broj artikla	22.551.60	22.551.50



4 006825 627602



4 006825 628753

ELEKTRIČNE DIZALICE



	TC-EH 500 CLASSIC	TC-EH 250 CLASSIC
Napon	230 V ~ 50 Hz	230 V ~ 50 Hz
Snaga	800 W S3 20%	450 W S3 20%
Visina podizanja bez kolotura	11,5 m	11,5 m
Visina podizanja s koloturom	5,7 m	5,7 m
Nosivost bez kolotura	250 kg	125 kg
Nosivost s koloturom	500 kg	250 kg
Brzina bez kolotura	8 m/min	8 m/min
Brzina s koloturom	4 m/min	4 m/min
Težina proizvoda	15,6 kg	10,0 kg
Termalni prekidač	•	•
Automatska kočnica za osiguranje tereta	•	•
Automatsko isključivanje kod preopterećenja	•	•
Nesavrtljivi žičani kabel	•	•
Kontrolni prekidač s hitnim zaustavljanjem	•	•
Kolotur s teretnom kukom	•	•
Stezaljke za pričvršćivanje	•	•
Broj artikla	22.551.40	22.551.30



4 006825 627213



4 006825 627183

LANČANA DIZALICA



	TC-CH 1000 CLASSIC
Nosivost	1000 kg
Visina podizanja	2,5 m
Težina proizvoda	8,5 kg
Kuka za teret sa sigurnosnom bravom	•
Zatvoreno metalno kućište	•
Broj artikla	22.501.10



4 006825 628302

ZAKRETNNA KONZOLA



	SA 1100 ACCESSORY
Duljina nosača	75 - 110 cm
Maks. nosivost na duljini 75 cm	600 kg
Maks. nosivost na duljini 110 cm	300 kg
Kut zakretanja	180°
Težina proizvoda	8,3 kg
Broj artikla	22.553.98



4 006825 540017

POTEZNA RUČNA VITLA



	TC-LW 2000 CLASSIC	TC-LW 1000 CLASSIC
Maks. nosivost s vodilicom	2000 kg	1000 kg
Duljina čeličnog kabla	3,3 m	2,2 m
Promjer čeličnog kabla	6,0 mm	4,8 mm
Maks. koristiva udaljenost	1,6 m	1,2 m
Težina proizvoda	5,2 kg	2,8 kg
Automatska kočnica za osiguranje tereta	•	•
Kuka za teret sa sigurnosnom bravom	•	•
Sigurnosna hvataljka kabla	•	•
Nesavjetljivi žičani kabel	•	•
Povratni graničnik	•	•
Broj artikla	22.601.50	22.601.40



4 006825 643244



4 006825 643237

RUČNA VITLA



	TC-WI 800 CLASSIC	TC-WI 500 CLASSIC
Maks. snaga potezanja	800 kg	500 kg
Duljina čeličnog kabla	20 m	10 m
Promjer čeličnog kabla	4,8 mm	4,2 mm
Težina proizvoda	4,7 kg	2,5 kg
Automatska kočnica za osiguranje tereta	•	•
Kuka za teret sa sigurnosnom bravom	•	•
Sigurnosna hvataljka kabla	•	•
Nesavjetljivi žičani kabel	•	•
Povratni graničnik	•	•
Broj artikla	22.601.70	22.601.60



4 006825 643916



4 006825 643909

VILIČAR



	TC-PT 2500 CLASSIC
Maks. nosivost	2500 kg
Visina vilice	80 mm - 190 mm
Promjer nosivih kotača	80 mm
Promjer upravljačkih kotača	180 mm
Vilica duljina	1150 mm
Vilica širina	540 mm
Težina proizvoda	62,0 kg
Sigurnosno rudo s polugom izbora funkcija	•
Automatsko vraćanje ruda	•
Broj artikla	20.225.30



4 006825 615654

RADNI STOL



	WB 50
Maks. nosivost	50 kg
Širina	605 mm
Visina	785 mm
Duljina	235 - 350 mm
Sklopiv	•
Pribor	4 plastične stezaljke
Broj artikla	22.101.10



4 006825 501476

KOLICA ZA ALAT I OPREMU



	TC-TW 150 CLASSIC
Maks. nosivost	150 kg
Širina	685 mm
Visina	875 mm
Duljina	455 mm
Ladica 1	4x 50 mm
Ladica 2	2x 100 mm
Ladica 3	1x 205 mm
Težina proizvoda	52,5 kg
Broj artikla	45.101.51



4 006825 640960



	TC-TW 100 CLASSIC
Maks. nosivost	75 kg
Širina	616 mm
Visina	658 mm
Duljina	330 mm
Ladica 1	4x 70 mm
Ladica 2	1x 240 mm
Ladica 3	-
Težina proizvoda	18,7 kg
Broj artikla	45.101.70



4 006825 614305

INVERTERSKI BENZINSKI AGREGATI



	TE-IG 3500 EXPERT NOVO	TC-IG 2000 CLASSIC	TC-IG 1100 CLASSIC
Snaga 400 V	-	-	-
Snaga 230 V	3300 W S2 5 min 3200 W S1	2000 W S2 5 min 1800 W S1	1100 W S2 5 min 1000 W S1
Maks. snaga	4300 W	2400 W	1400 W
Broj okretaja	3600 min ⁻¹	4500 min ⁻¹	3600 min ⁻¹
Obujam	212 cm ³	105,6 cm ³	79 cm ³
Kapacitet rezervara	8,3 l	4 l	6,5 l
Vrijeme rada kod 2/3 opterećenja	6,5 h	5,3 h	5,4 h
Težina proizvoda	54,7 kg	21,6 kg	20,9 kg
Indikator razine spremnika	•	-	•
Mjerač napona	•	-	•
Inverterska tehnologija	•	•	•
Prekidač protiv preopterećenja	•	•	•
Zaštita niske razine ulja	•	•	•
Električni starter	•	-	-
Tip agregata	Sinkroni s inverterskom tehnologijom	Sinkroni s inverterskom tehnologijom	Sinkroni s inverterskom tehnologijom
Motor	4-taktni, zračno hlađen	4-taktni, zračno hlađen	4-taktni, zračno hlađen
Broj utičnica	2x 230 V, 2x USB, 1x 12V	2x 230 V, 2x USB	1x 230 V
Broj artikla	41.526.20	41.525.90	41.525.80



BENZINSKI AGREGATI



	TC-PG 65/E5 CLASSIC	TC-PG 55/E5 CLASSIC
Snaga 400 V	6500 W (2 min) / 3600 W (S1)	5500 W (2 min) 3600 W (S1)
Snaga 230 V	3400 W (5 min) / 3200 W (S1)	3300 W (2 min) 3000 W (S1)
Maks. snaga	8000 W	7500 W
Broj okretaja	3000 min ⁻¹	3000 min ⁻¹
Obujam	420 cm ³	389 cm ³
Kapacitet rezervara	25 l	25 l
Vrijeme rada kod 2/3 opterećenja	11,7 h	11,7 h
Težina proizvoda	83,3 kg	82,8 kg
Indikator razine spremnika	•	•
Mjerač napona	-	-
Automatska regulacija napona (AVR)	•	•
Prekidač protiv preopterećenja	•	•
Zaštita niske razine ulja	•	•
Električni starter	•	•
Tip agregata	Sinkroni	Sinkroni
Motor	4-taktni, zračno hlađen	4-taktni, zračno hlađen
Broj utičnica	1x 400 V, 2x 230 V, 1x 12 V	1x 400 V, 2x 230 V
Broj artikla	41.526.10	41.525.62



BENZINSKI AGREGATI



	TC-PG 35/E5 CLASSIC	TC-PG 25/1/E5 CLASSIC
Snaga 400 V	-	-
Snaga 230 V	3100 W (2 min) 2600 W (S1)	2400 W (2 min) 2100 W (S1)
Maks. snaga	4100 W	4150 W
Broj okretaja	3000 min ⁻¹	3000 min ⁻¹
Obujam	208 cm ³	212 cm ³
Kapacitet rezervara	15 l	15 l
Vrijeme rada kod 2/3 opterećenja	10,7 h	12,5 h
Težina proizvoda	42,1 kg	38,8 kg
Indikator razine spremnika	•	•
Mjerač napona	•	•
Automatska regulacija napona (AVR)	•	•
Prekidač protiv preopterećenja	•	•
Zaštita niske razine ulja	•	•
Električni starter	-	-
Tip agregata	Sinkroni	Sinkroni
Motor	4-taktni, zračno hlađen	4-taktni, zračno hlađen
Broj utičnica	2x 230 V	2x 230 V
Broj artikla	41.525.51	41.526.00



4 006825 644142



4 006825 657319

BENZINSKI AGREGAT



	TC-PG 10/E5 CLASSIC
Snaga 400 V	-
Snaga 230 V	800 W (1 min) 680 W (S1)
Maks. snaga	1000 W
Broj okretaja	3000 min ⁻¹
Obujam	63,5 cm ³
Kapacitet rezervara	4 l
Vrijeme rada kod 2/3 opterećenja	6,6 h
Težina proizvoda	18,8 kg
Indikator razine spremnika	-
Mjerač napona	-
Automatska regulacija napona (AVR)	-
Prekidač protiv preopterećenja	•
Zaštita niske razine ulja	-
Električni starter	-
Tip agregata	Sinkroni
Motor	2-taktni, zračno hlađen
Broj utičnica	1x 230 V
Broj artikla	41.525.35



4 006825 648027

PRIBOR ZA BUŠENJE I UVRTANJE VIJAKA

PRIBOR ZA AKU BUŠILICE



	Set svrdla i bitova u kovčegu, 22/1	Set svrdla i bitova u kovčegu, 39/1	Set svrdla i bitova u kovčegu, 39/1
Opseg isporuke	22 kom	39 kom	39 kom
Bitovi za uvrtnanje vijaka	•	•	•
Svrdla za metal	•	•	•
Svrdla za drvo	-	-	•
Svrdla za beton	-	-	•
Pakiranje	Plastični kovčeg	Plastični kovčeg	Plastični kovčeg
Broj artikla	49108806	49108911	49108956



4 009311 088062



4 009311 089113



4 009311 089564

PRIBOR ZA AKU BUŠILICE



	Set bitova u kovčegu, 34/1	Set svrdla 15/1
Opseg isporuke	34 kom	15 kom: 3 kutije sa svrdlima - 5 kom svrdla u svakoj kutiji
Bitovi za uvrtnanje vijaka	•	-
Svrdla za metal	-	•
Svrdla za drvo	-	•
Svrdla za beton	-	•
Pakiranje	Plastični kovčeg	3x plastična kutija
Broj artikla	49108801	49109157



4 009311 088017



4 009311 091574

PRIBOR ZA AKU UDARNE ODVIJAČE



	Set bitova za udarni odvijač, 12/1
Opseg isporuke	12 kom
Pakiranje	Patentirana kutija za bitove
Područje primjene	Posebno za uporabu s udarnim odvijačima
Set se sastoji od	10 bitova, držač bitova, ručka
Broj artikla	49155025



4 009311 550255

PRIBOR ZA ČEKIĆ BUŠILICE



	SDS-plus set svrdla i dlijeta, 12/1
Opseg isporuke	10 svrdla, 2 dlijeta
Stezna glava	SDS-plus
Duljina	110 - 260 mm
Svrdlo-Ø	5 - 16 mm
Dlijeto	1x ravno 20 mm, 1x šiljasto
Pakiranje	Plastični kovčeg
Broj artikla	49240295

	SDS-plus set svrdla, 12/1
Opseg isporuke	12 svrdla
Stezna glava	SDS-plus
Duljina	110 - 260 mm
Svrdlo-Ø	5 - 14 mm
Dlijeto	-
Pakiranje	Plastični kovčeg
Broj artikla	49240281



PRIBOR ZA ČEKIĆ BUŠILICE

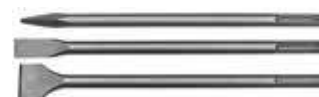
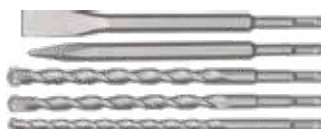

	SDS-max set svrdla i dlijeta u kovčegu, 5/1
Opseg isporuke	3 svrdla, 2 dlijeta
Stezna glava	SDS-max
Duljina	400 mm
Svrdlo-Ø	18, 20, 25 mm
Dlijeto	1x ravno 25 mm, 1x šiljasto
Pakiranje	Plastični kovčeg
Broj artikla	49194005

	SDS-max set dlijeta, 3/1
Opseg isporuke	3 dlijeta
Stezna glava	SDS-max
Duljina	400 mm
Svrdlo-Ø	-
Dlijeto	2x ravno (25 / 40 mm), 1x šiljasto
Pakiranje	Plastična cijev za odlaganje
Broj artikla	49190103



PRIBOR ZA ČEKIĆE ZA RAZBIJANJE



	SDS-hex ravno dlijeto 40x410 mm
Opseg isporuke	1 dlijeto
Stezna glava	SDS-hex
Duljina	410 mm
Širina	40 mm
Broj artikla	49191045

	SDS-hex šiljasto dlijeto 410 mm
Opseg isporuke	1 dlijeto
Stezna glava	SDS-hex
Duljina	410 mm
Širina	-
Broj artikla	49191145



PRIBOR ZA MJEŠAČE BOJE I LJEPILA

PRIBOR ZA MJEŠAČE BOJE I LJEPILA							
	Naziv	Broj artikla	EAN	Opseg isporuke	Ø	Duljina	Prihvat alata
	Miješalica za lak	49497005	4 009314 970050	1 kom	80 mm	400 mm	Hex
	Miješalica za boju	49497215	4 009314 972153	1 kom	100 mm	600 mm	Hex
	Miješalica za žbuku	49497615	4 009314 976151	1 kom	90 mm	600 mm	Hex
	Miješalica za žbuku M14	49497625	4 009314 976250	1 kom	120 mm	600 mm	M14
	Miješalica za boju M14	49497635	4 009314 976359	1 kom	120 mm	600 mm	M14
	Set miješalica M14	49497695	4 009314 976953	2 kom	120 mm (boja) / 135 mm (žbuka)	585 mm (boja) / 585 mm (žbuka)	M14
	Dvostruka miješalica za žbuku	49497795	4 009314 977950	1 par	120 mm	550 mm	Hex

PRIBOR ZA KUTNE BRUSILICE

PRIBOR ZA KUTNE BRUSILICE									
	Naziv	Broj artikla	EAN	Opseg isporuke	Ø	Ø Provrt	Granulacija	Broj lamela	Odgovara za
	Set lameliranih brusnih ploča	49795505	4 009317 955054	2 kom	115 mm	22 mm	P40 / P80 po 1 od svakog	62	Obrada metala i drva
	Set lameliranih brusnih ploča	49795705	4 009317 957058	2 kom	125 mm	22 mm	P40 / P80 po 1 od svakog	62	Obrada metala i drva
	Set lameliranih brusnih ploča	49795805	4 009317 958055	2 kom	150 mm	22 mm	P40 / P80 po 1 od svakog	76	Obrada metala i drva



PRIBOR ZA KUTNE BRUSILICE								
	Naziv	Broj artikla	EAN	Opseg isporuke	Ø	Ø Provrt	Debljina	Odgovara za
	Set dijamantnih reznih ploča	49797605	4 009317 976059	1 turbo, 1 segmentna rezna ploča	230 mm	22 mm	1,8 mm / 1,8 mm	Opeka, betonski blokovi, pločice
	Set tankih reznih ploča	49711949	4 009317 119494	5 kom	230 mm	22 mm	2,0 mm	Metal i nehrđajući čelik
	Set tankih reznih ploča	49711946	4 009317 119463	5 kom	150 mm	22 mm	1,4 mm	Metal i nehrđajući čelik
	Dijamantna tanka rezna ploča	49721550	4 009317 215509	1 kom	150 mm	22 mm	1,6 mm	Kamen, beton, pločice, keramika, porculanska keramika, mramor, granit
	Set tankih reznih ploča	49711945	4 009317 119456	10 kom	125 mm	22 mm	1,0 mm	Metal i nehrđajući čelik
	Dijamantna tanka rezna ploča	49724550	4 009317 245506	1 kom	125 mm	22 mm	1,4 mm	Kamen, beton, pločice, keramika, porculanska keramika, mramor, granit
	Set tankih reznih ploča	49711944	4 009317 119449	10 kom	115 mm	22 mm	1,0 mm	Metal i nehrđajući čelik
	Dijamantna tanka rezna ploča	49721150	4 009317 211501	1 kom	115 mm	22 mm	1,2 mm	Kamen, beton, pločice, keramika, porculanska keramika, mramor, granit

PRIBOR ZA KUTNE BRUSILICE

PRIBOR ZA KUTNE BRUSILICE					
	Naziv	Broj artikla	EAN	Nastavak	Pakiranje
	Matica za brzo otpuštanje	49717705	4 009317 177050	M14	Karton

PRIBOR ZA KUTNE BRUSILICE					
	Naziv	Broj artikla	EAN	Za kutne brusilice s pločom-Ø	Pakiranje
	TS 115/125 Stalac za kutne brusilice	44.310.44	4 006825 632736	115 / 125 mm	Karton
	TS 230/1 Stalac za kutne brusilice	44.310.51	4 006825 632743	230 mm	Karton

PRIBOR ZA GLODALICU ZA UTORE U ZIDU

PRIBOR ZA GLODALICU ZA UTORE U ZIDU								
	Naziv	Broj artikla	EAN	Opseg isporuke	Ø	Ø Provrt	Debljina	Odgovara za
	Set dijamantnih reznih ploča 125 mm	43.507.36	4 006825 671087	2 kom	125 mm	22 mm	1,8 mm	Kamen, beton, pločice, keramika, porculanska keramika, mramor, granit
	Set dijamantnih reznih ploča 150 mm	43.507.41	4 006825 670875	2 kom	150 mm	22 mm	1,8 mm	Kamen, beton, pločice, keramika, porculanska keramika, mramor, granit

PRIBOR ZA GLODALICU ZA UTORE

PRIBOR ZA GLODALICU ZA UTORE							
	Naziv	Broj artikla	EAN	Ø	Ø Provrt	Širina rezanja	Broj zuba
	Glodalo 100x22x4 mm 6Z, za TC-BJ 900	49758941	4 009317 589419	100 mm	22 mm	4,0 mm	6



PRIBOR ZA GLODALICE

PRIBOR Z AGLODALICE					
	Naziv	Broj artikla	EAN	Opseg isporuke	Pakiranje
	Set glodala 8 mm, 15/1 u drvenom kovčegu	49757291	4 009317 572916	15 kom	Drveni kovčeg

PRIBOR ZA BLANJE

PRIBOR ZA BLANJE							
	Naziv	Broj artikla	EAN	Opseg isporuke	Duljina	Materijal	Pakiranje
	Set noževa	49568315	4 009315 683157	2 reverzibilna noža	82 mm	Tvrdi metal	Karton

PRIBOR ZA PILE

PRIBOR ZA UBODNE PILE					
	Naziv	Broj artikla	EAN	Opseg isporuke	Pakiranje
	Set listova pile za ubodnu pilu, 10/1	49617350	4 009316 173503	10 listova pile: 6x list pile za tvrdo i meko drvo (2x fini, srednji, grubi), 1x list pile za laminat, 1x list pile za drvene ploče, plastiku 1x list pile za koso rezanje, 2x list pile za metal, aluminij, plastiku, drvo s metalnim ostacima	Plastična kutija
	Set listova pile za ubodne pile, 4/1, Akku-Top	49625427	4 009316 254271	2x list pile za laminat, drvene ploče, plastiku, 1x list pile za tvrdo i meko drvo, 1x list pile za metal, aluminij, plastiku, drvo s metalnim ostacima	Plastično pakiranje

PRIBOR ZA RUČNE KRUŽNE PILE								
	Naziv	Broj artikla	EAN	Ø	Širina reza / debljina oštrice	Ø Provrt	Broj zuba	Vrsta lista pile
	TCT list pile, 150x16 mm, 20Z	49583359	4 009315 833590	150 mm	1,6 mm / 1,0 mm	Ø 16 mm	20	Karbidni vrh
	TCT list pile, 165x20 mm, 20Z	49584759	4 009315 847597	165 mm	1,6 mm / 1,0 mm	Ø 20 mm	20	Karbidni vrh
	TCT list pile, 190x30 mm, 30Z	49586956	4 009315 869568	190 mm	2,0 mm / 1,3 mm	Ø 30 mm	30	Karbidni vrh

PRIBOR ZA MINI RUČNE KRUŽNE PILE							
	Naziv	Broj artikla	EAN	Ø	Ø Provrt	Broj zuba	Dijamantna rezna ploča
	Set listova pile	49575915	4 009315 759159	89 mm	10 mm	72 (HSS) / 36 (HM)	Puni rub

PRIBOR ZA RUČNE KRUŽNE PILE								
	Naziv	Broj artikla	EAN	Odgovara za	Set	Duljina (ukupno)	Pakiranje	
	Aluminijska vodilica 2x 1000 mm	45.021.18	4 006825 632675	TE-PS 165 TC-CS 1250 TC-CS 1410 TE-CS 165 TE-CS 190/1 TE-CS 18/150 Li TE-CS 18/165-1 Li TP-CS 18/190 Li BL	2 kom	2000 mm	Karton	

PRIBOR ZA VIŠENAMJENSKE PILE

	Naziv	Broj artikla	EAN	Set se sastoji od
	Set listova pile za višenamjensku pilu, 3/1, Akku Top	49576105	4 009315 761053	1x oštrica pile za fino rezanje, 1x list pile za grubo rezanje, 1x list pile za metal, plastiku, drvo s metalnim ostacima, bimetal



PRIBOR ZA VIŠENAMJENSKI ALAT





	Set nastavaka za višenamjenski alat, 17/1	Set nastavaka za pod za višenamjenski alat, 4/1	Set nastavaka za pločice za višenamjenski alat, 4/1
Opseg isporuke	17 kom	4 kom	4 kom
Strugač	-	•	-
Listovi pile za uranjanje	2x drvo/plastika, 1x metal	2x drvo/plastika	-
Segmentni list pile	1x drvo/metal/plastika	1x drvo/metal/plastika	1x fuge pločica/vapneni kamen/porobeton
Turpija	-	-	1x žbuka/ljepilo za pločice/ostaci tepiha
Trokutasti nosač brusnog papira	1x 93 mm	-	-
Brusni papir (drvo, metal, plastika)	P40, P80, P120 (po 4x od svakoga)	-	-
Strugač za silikonske fuge	-	-	1x 28x50 mm
Lopatica za izravnjavanje silikonskih fuga	-	-	Za uske i široke silikonske fuge
Broj artikla	49708950	49708850	49708750



PRIBOR ZA ALATE ZA BRUŠENJE I GRAVIRANJE

	Naziv	Broj artikla	EAN	Opseg isporuke	Odgovara za	Pakiranje
	Set pribora za brušenje i graviranje	49510950	4 009315 109503	61 kom	Alati za brušenje/graviranje	Plastični kovčeg
	Set pribora za brušenje i graviranje	49510951	4 009315 109510	38 kom	Alati za brušenje/graviranje i stolne brusilice	Plastični kovčeg

PRIBOR ZA VIBRACIONE BRUSILICE

	Naziv	Broj artikla	EAN	Veličina brusnog papira	Opseg isporuke	Granulacija	Rupe	Odgovara za
	Set brusnih papira 15/1 (P60/P120/P180), 187x93 mm	49817985	4 009318 179855	187 x 93 mm	15 kom	P60 / P120 / P180 po 5x od svakoga	•	Drvo i metal
	Set brusnih papira 15/1 (P40/P80/P120), 230x115 mm	49818975	4 009318 189755	230 x 115 mm	15 kom	P40 / P80 / P120 po 5x od svakoga	•	Drvo i metal

PRIBOR ZA BRUSILICE

PRIBOR ZA TRAČNE BRUSILICE								
	Naziv	Broj artikla	EAN	Veličina brusnog papira	Opseg isporuke	Granulacija	Odgovara za	
	Set brusnih traka 5/1 (gr. 40/80/120), 75x533 mm	49912575	4 009319 125752	75 x 533 mm	5 kom	2x P40, 2x P80, 1x P120	Drvo i metal	

PRIBOR ZA TROKUTASTE BRUSILICE								
	Naziv	Broj artikla	EAN	Veličina brusnog papira	Opseg isporuke	Granulacija	Rupe	Odgovara za
	Set brusnih papira 20/1 (P60/P120/P180), 93x93x93 mm	49492874	4 009314 928747	93 x 93 x 93 mm	20 kom	8x P60, 6x P120, 6x P180	•	Drvo i metal

PRIBOR ZA VIŠENAMJENSKE BRUSILICE								
	Naziv	Broj artikla	EAN	Veličina brusnog papira	Opseg isporuke	Granulacija	Rupe	Odgovara za
	Set brusnih papira 15/1 (P60/P120/P180), 150x150x100 mm	49496174	4 009314 961744	150 x 150 x 100 mm	15 kom	P60 / P120 / P180 po 5x od svakoga	•	Drvo i metal

PRIBOR ZA EKSCENTRIČNE BRUSILICE								
	Naziv	Broj artikla	EAN	Veličina brusnog papira	Opseg isporuke	Granulacija	Rupe	Odgovara za
	Set brusnih papira 25/1 (P60/P120/P180), 125 mm	49491974	4 009314 919745	Ø 125 mm	25 kom	9x P60, 8x P120, 8x P180	•	Drvo i metal

PRIBOR ZA BRUSILICE ZA ZIDOVE I STROPOVE								
	Naziv	Broj artikla	EAN	Opseg isporuke	Ø	Mreža za brušenje, univerzalna	Brusni papir, bijeli	Brusni papir, crveni
	Set brusnog papira 225 mm, 5/1, (3x P80, 2x P120)	49491006	4 009314 910063	5 kom	225 mm	3x P80, 2x P120	–	–
	Set brusnog papira 225 mm, 15/1, (10x P80, 5x P120)	49491066	4 009314 910667	15 kom	225 mm	4x P80 / 2x P120 za smjesu za ispunu / akrilni lak	4x P80 / 2x P120 za lakove, tvrdo/ meko drvo	2x zrna 80 / 1x zrna 120 za drvo, metal, plastiku

PRIBOR ZA BRUSILICE ZA ZIDOVE I STROPOVE

	Naziv	Broj artikla	EAN	Opseg isporuke	Set se sastoji od
	Set brusnih papira 5/1 (2xP80, 2xP80 trokutasti, 1xP120), Ø225	49491005	4 009314 910056	5 kom	3x mreža za brušenje, univerzalna Ø225 mm (2x P80, 1x P120) za smjesu za ispunu i akrilni lak, 2x trokutasta mreža za brušenje 287x287x287 mm (2x P80)
	Set brusnih papira 15/1 (8xP80, 5xP80 trokutasti, 2xP120), Ø225	49491065	4 009314 910650	15 kom	4x mreža za brušenje, univerzalna Ø225 mm (3x P80, 1x P120) za smjesu za ispunu i akrilni lak, 2x trokutasta mreža za brušenje 287x287x287 mm (2x P80), 5x brusni papir Ø225 (4x P80, 1x P120), 2x trokutasti brusni papir 287x287x287 mm (2x P80) za lak i plastiku, 1x brusni papir, crveni Ø225 mm (1x P80), 1x trokutasti brusni papir, crveni 287x287x287 mm (1x P80)
	Set trokutastih brusnih papira 5/1 (5x P80), 287x287x287 mm	49491075	4 009314 910759	5 kom	2x trokutasta mreža za brušenje 287x287x287 mm (2x P80), 2x trokutasti brusni papir 287x287x287 mm (2x P80), 1x trokutasti brusni papir, crveni 287x287x287 mm (1x P80)

PRIBOR ZA AKUMULATORSE POLIRKE I KUTNE POLIRKE

	Naziv	Broj artikla	EAN	Odgovara za	Set se sastoji od
	Set za polirku, Ø254 mm, za CE-CB 18/254 Li, CC-PO 90	20.930.95	4 006825 631517	CE-CB 18/254 Li, CC-PO 90	1x tekstilna navlaka, 1x sintetička navlaka
	Pribor za kutnu polirku, Ø180 mm, za CE-CP 18/180 Li, CC-PO 1100/2 E	20.932.33	4 006825 551846	CE-CP 18/180 Li E, CC-PO 1100/2 E	2x sintetička navlaka, 1x spužvasta navlaka, 6x brusni papir (2x P60/2x P80/2x P120)
	Pribor za poliranje, Ø150 mm, uklj. brusni disk	20.932.45	4 006825 653977	CE-CP 18/180 Li E	1x brusni disk Ø150 mm, 2x sintetička navlaka, 1x spužvasta navlaka, 6x brusni papir (2x P60/2x P80/2x P120)

OSTALI PRIBOR



PRIBOR ZA SISTEME/PIŠTOLJE ZA PRSKANJE BOJE

	Naziv	Broj artikla	EAN	Kapacitet	Pakiranje
	Set za sisteme/pištolje za prskanje boje	42.600.03	4 006825 619515	800 ml	Karton
	Spremnik za boju, 1000 ml	42.600.02	4 006825 619508	1000 ml	Karton
	Spremnik za boju, 800 ml	42.600.01	4 006825 619492	800 ml	Karton



PRIBOR ZA PIŠTOLJE ZA VRUĆE LJEPLJENJE

	Naziv	Broj artikla	EAN	Ø	Duljina	Količina
	Patrone za ljepljenje	49538955	4 009315 389554	7 mm	150 mm	24 kom
	Patrone za ljepljenje	49539355	4 009315 393551	11 mm	150 mm	24 kom

PRIBOR ZA KLAMERICICE

	Naziv	Broj artikla	EAN	Tip	Duljina	Širina	Količina	Pogodan za
	Set spajalica za klamericu, tip 53, 1000/1, za TC-EN 20 E, TC-CT 3,6 Li	49353508	4 009313 535083	53	8 mm	11,4 mm	1000 kom	TC-CT 3,6 Li TC-EN 20 E
	Set čavlića za klamericu, tip 47/55, 1000/1, za TC-EN 20 E	49355614	4 009313 556149	55	14 mm	1,8 mm	1000 kom	TC-EN 20 E

PRIBOR ZA AKUMULATORSKU KLAMERICICE I PNEUMATSKE KLAMERICICE

	Naziv	Broj artikla	EAN	Tip	Duljina	Širina	Količina	Pogodan za
	Set spajalica za klamericu, 3000 kom, 5x40 mm	41.378.61	4 006825 505788	E	40 mm	5,7 mm	3000 kom	TC-PN 50 Fixetto 18/38 S
	Set spajalica za klamericu, 3000 kom, 5x25 mm	41.378.60	4 006825 504446	E	25 mm	5,7 mm	3000 kom	TC-PN 50 Fixetto 18/38 S
	Set spajalica za klamericu, tip E (19x5,7 mm), 3000/1	41.378.75	4 006825 658385	E	19 mm	5,7 mm	3000 kom	TE-CN 18 Li Fixetto 18/38 S
	Set spajalica za klamericu, 3000 kom, 5x16 mm	41.378.55	4 006825 504439	E	16 mm	5,7 mm	3000 kom	TE-CN 18 Li TC-PN 50 Fixetto 18/38 S
	Set spajalica za klamericu, 3000 kom, 5x13 mm	41.378.50	4 006825 504422	E	13 mm	5,7 mm	3000 kom	TC-PN 50 Fixetto 18/38 S
	Set čavlića za klamericu, 3000 kom, 50 mm	41.378.73	4 006825 505795	J	50 mm	1,0 mm	3000 kom	TC-PN 50 Fixetto 18/50 N
	Set čavlića za klamericu, 3000 kom, 50 mm	41.378.72	4 006825 504866	J	40 mm	1,0 mm	3000 kom	TC-PN 50 Fixetto 18/50 N
	Set čavlića za klamericu, tip J (32x1,0 mm), 3000/1	41.378.74	4 006825 658378	J	32 mm	1,0 mm	3000 kom	TE-CN 18 Li Fixetto 18/38 S
	Set čavlića za klamericu, 3000 kom, 25 mm	41.378.71	4 006825 504460	J	25 mm	1,0 mm	3000 kom	TE-CN 18 Li TC-PN 50 Fixetto 18/50 N

PRIBOR ZA LASERSKU MJERNU TEHNOLOGIJU

	Naziv	Broj artikla	EAN	Radna visina	Podešavanje kuta nagiba	Torba	Težina proizvoda	Pakiranje
	Gradjevni stativ za nivelire	22.701.15	4 006825 616255	37 - 110 cm	•	•	0,5 kg	Karton

PRIBOR ZA STACIONARNE PILE - KLIZNA VODILICA



	ST 315
Podešavanje kuta	0° - 55°
Pogodan za	TC-TS 315 U TE-TS 315 U TE-TS 315 UD
Broj artikla	43.405.59



4 006825 648744

PRIBOR ZA PREKLOPNE PILE



	E-Stand
Montažna širina	340 - 445 mm
Montažna dubina	maks. 410 mm
Visina stola	81 cm
Broj artikla	43.106.20



4 006825 584974

PRIBOR ZA PREKLOPNE PILE



	MSS 1610 ACCESSORY	MSS 1608 ACCESSORY
Ukupna duljina	1120 - 1610 mm	1050 - 1630 mm
Dozvoljeno opterećenje maks.	100 kg	80 kg
Radna visina	845 - 945 mm	755 - 855 mm
Duljina nosača za preklopne pile maks.	455 mm	375 mm
Brzo podešavanje	•	-
Držači radnog komada	•	-
Noge podesive po visini	•	-
Pretinci za pohranu sitnog pribora	•	-
Sklopivi stalak	•	•
Ručka za nošenje	•	-
Nosači za preklopne pile	1 par	1 par
Broj artikla	43.106.15	43.106.14









4 006825 637496



4 006825 660050

PRIBOR ZA STOLNE KRUŽNE PILE, POTEZNE PREKLOPNE PILE I PREKLOPNE PILE

	Naziv	Broj artikla	EAN	Ø	Ø Provrt	Širina reza / debljina oštrice	Broj zuba	Vrsta lista pile	Pakiranje
	HM list pile	49587151	4 009315 871516	200 mm	16 mm	2,4 mm / 1,6 mm	20	Karbidni vrh	–
	HM list pile	45.020.67	4 006825 667790	210 mm	30 mm	2,6 mm / 1,6 mm	24	Karbidni vrh	–
	HM tanki list pile	49587852	4 009315 878522	210 mm	30 mm	1,8 mm / 1,2 mm	40	Karbidni vrh	–
	HM list pile	49587861	4 009315 878614	210 mm	30 mm	2,4 mm / 1,6 mm	48	Karbidni vrh	–
	HM tanki list pile	49587862	4 009315 878621	210 mm	30 mm	1,8 mm / 1,2 mm	64	Karbidni vrh	–
	HM set listova pile, 3/1	49587805	4 009315 878058	210 mm	30 mm	2,5 mm / 1,6 mm	24 / 42 / 60	Karbidni vrh	Plastični kovčeg
	HM list pile	49588261	4 009315 882611	216 mm	30 mm	2,4 mm / 1,6 mm	60	Karbidni vrh	–
	HM list pile	49588251	4 009315 882512	216 mm	30 mm	2,4 mm / 1,6 mm	48	Karbidni vrh	–
	HM set listova pile, 3/1	49587806	4 006825 661996	216 mm	30 mm	2,4 mm / 1,6 mm	24 / 42 / 60	Karbidni vrh	Plastični kovčeg
	HM tanki list pile	49589352	4 009315 893525	250 mm	30 mm	1,8 mm / 1,2 mm	42	Karbidni vrh	–
	HM list pile	49589341	4 009315 893419	250 mm	30 mm	3,2 mm / 2,2 mm	24	Karbidni vrh	–
	HM list pile	49589351	4 009315 893518	250 mm	30 mm	3,2 mm / 2,2 mm	48	Karbidni vrh	–
	HM list pile	49589552	4 009315 895529	250 mm	30 mm	3,2 mm / 2,2 mm	60	Karbidni vrh	–
	HM set listova pile, 2/1	49589305	4 009315 893051	250 mm	30 mm	3,2 mm / 2,2 mm	24 / 60	Karbidni vrh	Plastični kovčeg
	HM set listova pile, 3/1	49589306	4 009315 893068	250 mm	30 mm	3,2 mm / 2,2 mm	24 / 42 / 60	Karbidni vrh	Plastični kovčeg
	HM tanki list pile	49589361	4 009315 893617	254 mm	30 mm	1,8 mm / 1,2 mm	42	Karbidni vrh	–
	HM list pile	49589551	4 009315 895512	254 mm	30 mm	3,2 mm / 2,2 mm	48	Karbidni vrh	–
	HM list pile	49589561	4 009315 895611	254 mm	30 mm	3,2 mm / 2,2 mm	60	Karbidni vrh	–
	HM set listova pile, 3/1	49589307	4 006825 662009	254 mm	30 mm	3,2 mm / 2,2 mm	24 / 42 / 60	Karbidni vrh	Plastični kovčeg
	HM list pile	49592957	4 009315 929576	305 mm	30 mm	3,0 mm / 2,2 mm	40	Karbidni vrh	–
	HM list pile	49593151	4 009315 931517	315 mm	30 mm	3,2 mm / 2,2 mm	48	Karbidni vrh	–

PRIMJENA PRIBORA ZA STOLNE KRUŽNE PILE, POTEZNE PREKLOPNE PILE I PREKLOPNE PILE

			Potezne preklopne pile										Preklopne pile			Stolne kružne pile																	
			TE-SM 36/254 Li - Solo	TE-SM 36/210 Li - Solo	TE-MS 18/210 Li - Solo	TE-TS 36/210 Li - Solo	TE-SM 254 Dual	TE-SM 2534 Dual	TC-SM 2534/1 Dual	TC-SM 254	TC-SM 2531/2 U	TE-SM 2131 Dual	TE-SM 216 Dual	TC-SM 2131/2 Dual	TC-SM 216	TC-MS 2513 L	TC-MS 2112	TC-MS 216	TC-MS 3017 T	TE-CC 250 UF	TE-TS 250 UF	TC-TS 2225 U	TC-TS 254 U	TC-TS 2025/2 U	TC-TS 2025/3 eco	TC-TS 254 eco	TE-TS 315 UD	TE-TS 315 U	TC-TS 315	TE-TS 254 T	TC-TS 210	TC-TS 200	
			43.008.85	43.008.80	43.008.90	43.404.50	43.008.75	43.008.70	43.003.95	43.003.85	43.008.05	43.008.60	43.008.65	43.003.90	43.003.80	43.008.50	43.002.95	43.003.70	43.003.47	43.405.39	43.405.68	43.405.15	43.405.10	43.404.90	43.404.95	43.405.05	43.405.58	43.405.57	43.405.56	43.404.30	43.404.25	43.404.15	
ø 200 mm	HM ø 200 x 16 x 2,4 mm Z20	49587151	-	-	-	-	-	-	-	-	-	-	-	-	-	-	-	-	-	-	-	-	-	-	-	-	-	-	-	-	-	•	
ø 210 mm	HM ø 210 x 30 x 2,6 mm Z24	45.020.67	-	•	•	•	-	-	-	-	-	•	-	•	-	•	-	-	-	-	-	-	-	-	-	-	-	-	-	-	•	-	
	HM tanki ø 210 x 30 x 1,8 mm Z40	49587852	-	•	•	•	-	-	-	-	-	-	-	-	-	-	-	-	-	-	-	-	-	-	-	-	-	-	-	-	-	-	
	HM ø 210 x 30 x 2,4 mm Z48	49587861	-	•	•	•	-	-	-	-	-	•	-	•	-	•	-	-	-	-	-	-	-	-	-	-	-	-	-	-	-	•	-
	HM tanki ø 210 x 30 x 1,8 mm Z64	49587862	-	•	•	•	-	-	-	-	-	•	-	-	-	-	-	-	-	-	-	-	-	-	-	-	-	-	-	-	-	-	-
	HM ø 210 x 30 x 2,5 mm Z24/Z42/Z60	49587805	-	•	•	•	-	-	-	-	-	•	-	•	-	•	-	-	-	-	-	-	-	-	-	-	-	-	-	-	-	•	-
ø 216 mm	HM ø 216 x 30 x 2,4 mm Z60	49588261	-	-	-	-	-	-	-	-	-	•	-	•	-	-	•	-	-	-	-	-	-	-	-	-	-	-	-	-	-	-	
	HM ø 216 x 30 x 2,4 mm Z48	49588251	-	-	-	-	-	-	-	-	-	•	-	•	-	-	•	-	-	-	-	-	-	-	-	-	-	-	-	-	-	-	
	HM ø 216 x 30 x 2,4 mm Z24/Z42/Z60	49587806	-	-	-	-	-	-	-	-	-	•	-	•	-	-	•	-	-	-	-	-	-	-	-	-	-	-	-	-	-	-	
ø 250 mm	HM tanki ø 250 x 30 x 1,8 mm Z42	49589352	-	-	-	-	-	•	•	-	-	-	-	-	-	•	-	-	-	-	•	•	-	-	•	•	-	-	-	-	-	-	
	HM ø 250 x 30 x 3,2 mm Z24	49589341	-	-	-	-	-	•	•	-	-	-	-	-	-	•	-	-	-	•	•	-	-	•	•	-	-	-	-	-	-	-	
	HM ø 250 x 30 x 3,2 mm Z48	49589351	-	-	-	-	-	•	•	-	-	-	-	-	-	•	-	-	-	•	•	-	-	•	•	-	-	-	-	-	-	-	
	HM ø 250 x 30 x 3,2 mm Z60	49589552	-	-	-	-	-	•	•	-	-	-	-	-	-	•	-	-	-	•	•	-	-	•	•	-	-	-	-	-	-	-	
	HM ø 250 x 30 x 3,2 mm Z24/Z60	49589305	-	-	-	-	-	•	•	-	-	-	-	-	-	•	-	-	-	•	•	-	-	•	•	-	-	-	-	-	-	-	
	HM ø 250 x 30 x 3,2 mm Z24/Z42/Z60	49589306	-	-	-	-	-	•	•	-	-	-	-	-	-	•	-	-	-	•	•	-	-	•	•	-	-	-	-	-	-	-	
ø 254 mm	HM tanki ø 254 x 30 x 1,8 mm Z42	49589361	•	-	-	-	•	-	•	•	-	-	-	-	-	-	-	-	-	-	-	-	-	-	-	-	-	-	-	-	-	-	
	HM ø 254 x 30 x 3,2 mm Z48	49589551	•	-	-	-	•	-	•	•	-	-	-	-	-	-	-	-	-	-	-	•	•	-	-	•	•	-	-	-	•	-	-
	HM ø 254 x 30 x 3,2 mm Z60	49589561	•	-	-	-	•	-	•	•	-	-	-	-	-	-	-	-	-	-	-	•	•	-	-	•	•	-	-	-	•	-	-
	HM ø 254 x 30 x 3,2 mm Z24/Z42/Z60	49589307	•	-	-	-	•	-	•	•	-	-	-	-	-	-	-	-	-	-	-	•	•	-	-	•	•	-	-	-	•	-	-
ø 305 mm	HM ø 305 x 30 x 3,0 mm Z40	49592957	-	-	-	-	-	-	-	-	-	-	-	-	-	-	-	-	•	-	-	-	-	-	-	-	-	-	-	-	-	-	
ø 315 mm	HM ø 315 x 30 x 3,2 mm Z48	49593151	-	-	-	-	-	-	-	-	-	-	-	-	-	-	-	-	-	-	-	-	-	-	-	•	•	•	-	-	-	-	-

• Moguća upotreba - Upotreba nije moguća



PRIBOR ZA STOLNE BLANJE

	Naziv	Broj artikla	EAN	Odgovara za	Duljina	Visina	Debljina	Količina
	Rezervni nož za blanjicu TC-SP 204	49568602	4 009315 686028	TH-SP 204 TC-SP 204 TC-SP 204/1	210 mm	17,2 mm	1,5 mm	2 kom

PRIBOR ZA PILE ZA PROREZIVANJE

	Naziv	Broj artikla	EAN	Količina	Duljina	Veličina	Odgovara za
	List pile 127 mm, 5/1, za TC-SS 405 E	49316350	4 009313 163507	5 kom	127 mm	1x vrlo fino (24 Zpi), 2x fino (18 Zpi), 1x srednje (15 Zpi), 1x grubo (10 Zpi)	Drvo
	List pile 127 mm, 10/1, za TC-SS 405 E	49316352	4 009313 163521	10 kom	127 mm	Vrlo fino (24 Zpi)	Drvo

PRIBOR ZA TRAČNE PILE

	Naziv	Broj artikla	EAN	Duljina	Širina	Debljina	Broj zuba	Odgovara za
	List pile 1400x8 mm, Z6/25 mm, za TC-SB 200/1	49081505	4 009310 815058	1400 mm	8,0 mm	0,65 mm	6 Zpi	Drvo
	List pile 1712x6 mm, Z6/25 mm	49081506	4 009310 815065	1712 mm	6,0 mm	0,65 mm	6 Zpi	Drvo
	List pile 2320x13 mm, 4Z/25 mm, za TC-SB 305 U	49081509	4 009310 815096	2320 mm	13 mm	0,65 mm	4 Zpi	Drvo
	List pile 1141x13 mm, 10Z/25mm, 14Z/25mm, set, 3/1	45.061.60	4 006825 663112	1141 mm	13 mm	0,65 mm	10/14 Zpi	Drvo / metal / plastika

PRIBOR ZA TOKARSKÉ STROJEVE

	Naziv	Broj artikla	EAN	Opseg isporuke	Sastoji se od
	Set dljeteta, 5/1, za TC-WW 1000	49455250	4 009314 552508	5 kom	Ravno, udubljeno, šuplje, okruglo, šiljasto dljeteto (po 1x od svakoga)

PRIBOR ZA TOKARSKÉ STROJEVE

	Naziv	Broj artikla	EAN	Nastavak	Područje stezanja vanjsko	Područje stezanja unutarnje	Težina proizvoda
	Stezna glava s četiri čeljusti	43.112.03	4 006825 635720	M18 navoj	45 - 134 mm	18 - 52 mm	2,5 kg

PRIBOR ZA INDUSTRIJSKI USISAVAČ

	Naziv	Broj artikla	EAN	Duljina / promjer crijeva	Ø adapter	Usisni adapter do 36 mm	Slijepi čep
	Set adaptera za industrijski usisavač	43.106.30	4 006825 587715	1200 mm / 36 mm	100 mm	•	•

PRIBOR ZA AKUMULATORSKE USISAVAČE SUHO/MOKRO I USISAVAČE SUHO/MOKRO						
	Naziv	Broj artikla	EAN	Za volumen spremnika	Količina	Pogodan za
	Spuzvasti filter 10 l	23.511.35	4 006825 641424	10 l	5 kom	Pogledajte 160. stranicu s popisom
	Vrećica za prašinu 10 l	23.512.60	4 006825 641394	10 l	5 kom	Pogledajte 160. stranicu s popisom
	Tekstilni filter	23.511.40	4 006825 231151	–	1 kom	Pogledajte 160. stranicu s popisom
	Spuzvasti filter, veliki	23.511.34	4 006825 659368	–	5 kom	Pogledajte 160. stranicu s popisom
	Spuzvasti filter	23.511.32	4 006825 644098	–	5 kom	Pogledajte 160. stranicu s popisom
	Sintetička vrećica za prašinu 40 l	23.511.95	4 006825 625691	30 - 50 l	5 kom	Pogledajte 160. stranicu s popisom
	Sintetička vrećica za prašinu 25 l	23.511.90	4 006825 625684	15 - 25 l	5 kom	Pogledajte 160. stranicu s popisom
	Sintetička vrećica za prašinu 15 l	23.511.85	4 006825 625554	12 - 15 l	5 kom	Pogledajte 160. stranicu s popisom
	Vrećica za prašinu 40 l	23.511.80	4 006825 607468	40 - 50 l	5 kom	Pogledajte 160. stranicu s popisom
	Vrećica za prašinu 30 l	23.511.70	4 006825 528763	30 l	5 kom	Pogledajte 160. stranicu s popisom
	Vrećica za prašinu 25 l	23.511.50	4 006825 231281	25 l	5 kom	Pogledajte 160. stranicu s popisom
	Vrećica za prašinu 20 l	23.511.52	4 006825 236040	15 - 20 l	5 kom	Pogledajte 160. stranicu s popisom
	Vrećica za prašinu 15 l	23.511.65	4 006825 623154	15 l	5 kom	Pogledajte 160. stranicu s popisom
	Vrećica za prašinu 12 l	23.511.59	4 006825 606065	12 - 15 l	5 kom	Pogledajte 160. stranicu s popisom

PRIBOR ZA AKUMULATORSKE USISAVAČE SUHO/MOKRO I USISAVAČE SUHO/MOKRO



	Posuda za pepeo s finim filterom, 18 L	Posuda za pepeo s filterom, 12 L
Kapacitet	18 l	12 l
Opseg isporuke	1 kom	1 kom
Duljina/promjer usisnog crijeva	100 cm / 36 mm	100 cm / 36 mm
Pogodan za	Pogledajte 160. stranicu s popisom	Pogledajte 160. stranicu s popisom
Broj artikla	23.516.12	23.516.06



PRIBOR ZA AKUMULATORSE USISAVAČE SUHO/MOKRO I USISAVAČE SUHO/MOKRO

	Naziv	Broj artikla	EAN	Opseg isporuke	Pogodan za
	Dvostruki filterski sistem	23.512.50	4 006825 630138	1 kom HEPA-filter (Klasifikacija: H13 (> 0,3 µm)), 1 kom dvostruka vreća za filter	Pogledajte 160. stranicu s popisom
	Dugotrajni filter za prašinu klase L	23.511.26	4 006825 657944	1 kom	Pogledajte 160. stranicu s popisom
	Dugotrajni filter	23.511.10	4 006825 231090	1 kom	Pogledajte 160. stranicu s popisom
	Dugotrajni filter s poklopcem	23.511.13	4 006825 566512	1 kom	Pogledajte 160. stranicu s popisom
	Fleksibilni dugi nastavak za usisavače	23.512.04	4 006825 653953	1 kom	Pogledajte 160. stranicu s popisom
	Podni nastavak s valjkom za usisavače	23.512.16	4 006825 671100	1 kom	Pogledajte 160. stranicu s popisom
	Univerzalni podni nastavak za usisavače	23.512.15	4 006825 630060	1 kom	Pogledajte 160. stranicu s popisom
	Nastavak za usisavanje kod bušenja	23.512.33	4 006825 653960	1 kom	Pogledajte 160. stranicu s popisom
	Okrugla četka za tepihe, nastavak za usisavače	23.512.30	4 006825 630091	1 kom	Pogledajte 160. stranicu s popisom
	Set nastavaka za usisavače, 3-dijelni	23.512.35	4 006825 630107	2 nastavka, 1 četka	Pogledajte 160. stranicu s popisom

**PRIBOR ZA AKUMULATORSE
USISAVAČE SUHO/MOKRO I
USISAVAČE SUHO/MOKRO**

Opseg isporuke	Set za čišćenje automobila
Duljina usisnog crijeva	7 kom
Promjer usisnog crijeva	300 cm
Pogodan za	36 mm
Broj artikla	Pogledajte 160. stranicu s popisom
	23.512.45



4 006825 630121

PRIBOR ZA AKUMULATORSKE USISAVAČE SUHO/MOKRO I USISAVAČE SUHO/MOKRO



	Premium crijevo za usisavač suho/mokro s nastavcima, 36 mm/3 m ACCESSORY	Crijevo za usisavač suho/mokro s nastavcima, 36 mm/3 m ACCESSORY	Produžetak usisne cijevi za usisavač suho/mokro ACCESSORY NOVO
Opseg isporuke	1 crijevo za teške uvjete rada, 3 adaptera	1 crijevo, 3 adaptera	1 crijevo
Duljina usisnog crijeva	300 cm	300 cm	300 cm
Promjer usisnog crijeva	36 mm	36 mm	36 mm
Pogodan za	Pogledajte 160. stranicu s popisom	Pogledajte 160. stranicu s popisom	Pogledajte 160. stranicu s popisom
Broj artikla	23.620.05	23.620.00	23.512.70



PRIBOR ZA AKUMULATORSKE ŠTAPNE USISAVAČE



	Četka za TE-SV 18 Li ACCESSORY NOVO	Filter za TE-SV 18 Li ACCESSORY NOVO	Set nastavaka za TE-SV 18 Li ACCESSORY NOVO
Opseg isporuke	1x četka	1x filter	1x crijevo, 1x podni, 1x uski podni nastavak
Pogodan za	TE-SV 18 Li	TE-SV 18 Li	TE-SV 18 Li
Prednost	Jednostavno promijenjiva	Perivi filter	Crijevo Ø36 mm za razne nastavke, priključke
Broj artikla	23.512.65	23.512.66	23.512.67



PRIBOR ZA AKU ČISTAČ PROZORA BRILLIANTO



	Set teleskopskih drška za Brillianto ACCESSORY NOVO	Set nastavaka za Brillianto ACCESSORY NOVO
Opseg isporuke	2 teleskopske drške (prodljive do cca. 1,2 m)	1x uski nastavak (165 mm), 1x široki nastavak (350 mm)
Pogodan za	Aku čistač prozora BRILLIANTO	Aku čistač prozora BRILLIANTO
Prednost	Jednostavna montaža, proširivo	Za rešetkaste prozore u zimskim vrtovima
Broj artikla	34.371.01	34.371.02



PRIMJENA PRIBORA ZA USISAVAČE SUHO/MOKRO

		23.516.06	23.516.12	23.512.50	23.511.26	23.511.10	23.511.13	23.511.40	23.511.34	23.511.32	23.511.35	23.511.95	23.511.90	23.511.85	23.511.80	23.511.70	23.511.50	23.511.52	23.511.65	23.511.59	23.512.60	23.512.04	23.512.16	23.512.15	23.512.33	23.512.30	23.512.35	23.512.45	23.620.05	23.620.00	23.512.70
		Posuda za pepeo s filterom, 12 L	Posuda za pepeo s finim filterom, 18 L	Dvostruki filterski sistem	Dugotrajni filter za prašinu klase L	Dugotrajni filter	Dugotrajni filter s poklopcem	Teksilni filter	Spužvasti filter, veliki	Spužvasti filter	Spužvasti filter 10 l	Simetička vrećica za prašinu 40 l	Simetička vrećica za prašinu 25 l	Simetička vrećica za prašinu 15 l	Vrećica za prašinu 40 l	Vrećica za prašinu 30 l	Vrećica za prašinu 25 l	Vrećica za prašinu 20 l	Vrećica za prašinu 15 l	Vrećica za prašinu 12 l	Vrećica za prašinu 10 l	Flexibilni dugi nastavak za usisavače	Podni nastavak s valjkom za usisavače	Univerzalni podni nastavak za usisavače	Nastavak za usisavanje kod bušenja	Okruga četka za tepihe za usisavače	Set nastavaka za usisavače, 3-dijelni	Set za čišćenje automobila	Premium zamjensko crijevo za usisavač	Zamjensko crijevo za usisavač	Produžetak usisne cijevi za usisavač
TP-VC 36/30 S Auto	23.471.43	-	-	-	-	•	•	•	-	•	-	•	-	-	•	-	-	-	-	-	-	•	•	•	•	•	•	•	•	•	•
TE-VC 36/30 Li S	23.471.40	-	-	-	-	•	•	•	-	•	-	•	-	-	•	-	-	-	-	-	-	•	•	•	•	•	•	•	•	•	•
TE-VC 36/25 Li S	23.471.70	-	-	-	-	•	•	•	-	•	-	•	-	-	•	-	-	-	-	-	-	•	•	•	•	•	•	•	•	•	•
TC-VC 18/20 Li S	23.471.30	-	-	-	-	-	•	•	-	•	-	-	•	-	-	-	-	-	-	-	-	•	•	•	•	•	•	•	•	•	•
TC-VC 18/15 Li	23.471.45	-	-	-	-	-	•	•	-	•	-	-	•	-	-	-	-	-	-	-	-	•	•	•	•	•	•	•	•	•	•
TE-VC 18/10 Li	23.471.60	-	-	-	-	-	-	-	-	-	•	-	-	-	-	-	-	-	-	-	-	•	•	•	•	•	•	•	•	•	•
TE-HV 18/06 Li	23.471.90	-	-	-	-	-	-	-	-	-	-	-	-	-	-	-	-	-	-	-	-	-	-	-	-	-	-	-	-	-	-
TE-VC 18 Li	23.471.20	-	-	-	-	-	-	-	-	-	-	-	-	-	-	-	-	-	-	-	-	-	-	-	-	-	-	-	-	-	-
TE-VC 2350 SACL	23.424.75	•	•	-	•	-	-	•	•	-	-	•	-	-	•	-	-	-	-	-	-	•	•	•	•	•	•	•	•	•	•
TE-VC 2340 SACL	23.424.70	•	•	-	•	-	-	•	•	-	-	•	-	-	•	-	-	-	-	-	-	•	•	•	•	•	•	•	•	•	•
TE-VC 2230 SACL	23.424.65	•	•	-	•	-	-	•	•	-	-	•	-	-	•	-	-	-	-	-	-	•	•	•	•	•	•	•	•	•	•
TE-VC 2025 SACL	23.424.60	•	•	-	•	-	-	•	•	-	-	•	-	-	•	-	-	-	-	-	-	•	•	•	•	•	•	•	•	•	•
TE-VC 2230 SA	23.423.63	•	•	•	-	•	•	•	-	•	-	•	-	-	•	-	-	-	-	-	-	•	•	•	•	•	•	•	•	•	•
TC-VC 1930 SA	23.421.90	•	•	-	-	•	•	•	-	•	-	•	-	-	•	-	-	-	-	-	-	•	•	•	•	•	•	•	•	•	•
TC-VC 1820 SA	23.424.25	•	•	-	-	•	•	•	-	•	-	•	-	-	•	-	-	-	-	-	-	•	•	•	•	•	•	•	•	•	•
TC-VC 1820 S	23.421.67	•	•	-	-	•	•	•	-	•	-	•	-	-	•	-	-	-	-	-	-	•	•	•	•	•	•	•	•	•	•
TC-VC 1815 S	23.423.90	-	-	-	-	-	-	-	-	-	-	-	•	-	-	-	-	-	-	-	-	•	•	•	•	•	•	•	•	•	•
TC-VC 1812 S	23.423.70	-	-	-	-	-	-	-	-	-	-	-	•	-	-	-	-	-	-	-	-	•	•	•	•	•	•	•	•	•	•
TC-VC 1825	23.424.30	•	•	-	-	•	•	•	-	•	-	•	-	-	•	-	-	-	-	-	-	•	•	•	•	•	•	•	•	•	•
TC-VC 1815	23.402.90	•	•	-	-	•	•	•	-	•	-	•	-	-	•	-	-	-	-	-	-	•	•	•	•	•	•	•	•	•	•

• Moguća upotreba - Upotreba nije moguća











PRIBOR ZA USISAVAČE PEPELA



Ilustrativna slika

	Dugotrajni filter za usisavače pepela ACCESSORY	Predfilter za usisavače pepela ACCESSORY	Uski nastavak za usisavače pepela ACCESSORY NOVO
Opseg isporuke	1 kom	1 kom	1 kom
Pogodan za	TC-AV 1720 DW / TC-AV 1718 D	Svi Einhell usisavači pepela	TC-AV 1720 DW / TC-AV 1718 D
Broj artikla	23.513.11	23.513.15	23.513.20



PRIBOR ZA VISOKOTLAČNE PERAČE						
	Naziv	Broj artikla	EAN	Maks. radni tlak	Duljina	Količina
	Čistač terase	41.440.15	4 006825 652000	170 bara	–	1
	Četka za pranje	41.440.16	4 006825 652246	170 bara	–	1
	Rotirajuća četka za pranje	41.440.17	4 006825 652253	170 bara	–	1
	Vodoravna četka za pranje	41.440.18	4 006825 652260	170 bara	–	1
	PVC visokotlačno crijevo	41.440.19	4 006825 652277	200 bara	6 m	1
	Kutna mlaznica	41.440.20	4 006825 652284	180 bara	–	1
	Spremnik za deterđent	41.440.21	4 006825 652291	170 bara	–	1
	Turbo mlaznica	41.440.22	4 006825 652307	170 bara	–	1
	Crijevo za čišćenje odvoda	41.440.23	4 006825 652314	200 bara	15 m	1
	Metalni nastavak s kutnom mlaznicom	41.440.24	4 006825 652321	180 bara	–	1

PRIBOR ZA AKUMULATORSKU KLAMERICU I PNEUMATSKU KLAMERICU

	Naziv	Broj artikla	EAN	Tip	Duljina	Širina	Količina	Pogodan za	Pakiranje
	Spajalice za TC-PN 50, 3000 kom, 5,7x40 mm	41.378.61	4 006825 505788	E, zašiljeni vrh	40 mm	5,7 mm	3000 kom	TC-PN 50	Karton
	Spajalice za TC-PN 50, 3000 kom, 5,7x25 mm	41.378.60	4 006825 504446	E, zašiljeni vrh	25 mm	5,7 mm	3000 kom	TC-PN 50	Karton
	Spajalice za TC-PN 50, 3000 kom, 5,7x16 mm	41.378.55	4 006825 504439	E, zašiljeni vrh	16 mm	5,7 mm	3000 kom	TE-CN 18 Li TC-PN 50	Karton
	Spajalice za TC-PN 50, 3000 kom, 5,7x13 mm	41.378.50	4 006825 504422	E, zašiljeni vrh	13 mm	5,7 mm	3000 kom	TC-PN 50	Karton
	Čavli za TC-PN 50, 3000 kom, 50 mm	41.378.73	4 006825 505795	J	50 mm	1,0 mm	3000 kom	TC-PN 50	Karton
	Čavli za TC-PN 50, 3000 kom, 40 mm	41.378.72	4 006825 504866	J	40 mm	1,0 mm	3000 kom	TC-PN 50	Karton
	Čavli za TC-PN 50, 3000 kom, 25 mm	41.378.71	4 006825 504460	J	25 mm	1,0 mm	3000 kom	TE-CN 18 Li TC-PN 50	Karton













PRIBOR ZA PNEUMATSKU EKSCENTRIČNU BRUSILICU

	Naziv	Broj artikla	EAN	Opseg isporuke	Ø	Granulacija	Rupe	Pogodan za
	Set brusnih papira za TC-PE 150, 150 mm, 5/1	49492095	4 009314 920956	5 kom	150 mm	2x P40, 2x P80, 1x P120	•	TC-PE 150

PRIBOR ZA PNEUMATSKI ČEKIĆ

	Naziv	Broj artikla	EAN	Opseg isporuke	Pogodan za	Pakiranje
	Igličasti nastavak za hrđu za pneumatski čekić TC-PC 45	41.331.20	4 006825 645873	1 kom	TC-PC 45 / TC-PC 45 Set	Karton
	Set dljeteta za pneumatski čekić TC-PC 45, 4/1	41.327.69	4 006825 653946	4 kom	TC-PC 45 / TC-PC 45 Set	Karton
	Zatezna opruga za pneumatski čekić TC-PC 45	41.327.68	4 006825 650013	1 kom	TC-PC 45 / TC-PC 45 Set	Plastična ambalaža

PRIBOR ZA KOMPRESORE					
	Naziv	Broj artikla	EAN	Karakteristike	Pakiranje
	Crijevo za kompresor 15 m, Ø9 mm	41.382.10	4 006825 574166	Duljina 15 m, unutarnji Ø: 9 mm	Folija
	Crijevo za kompresor 15 m, Ø6 mm	41.382.00	4 006825 410099	Duljina 15 m, unutarnji Ø: 6 mm	Folija
	Crijevo za kompresor 10 m, Ø6 mm	41.381.00	4 006825 410082	Duljina 10 m, unutarnji Ø: 6 mm	Folija
	Spiralno crijevo 8 m	41.394.20	4 006825 411744	Duljina 8 m, unutarnji Ø: 6 mm	Folija
	Spiralno crijevo 4 m	41.394.10	4 006825 411737	Duljina 4 m, unutarnji Ø: 6 mm	Folija
	Set adaptera za napuhavanje, 8/1	41.396.95	4 006825 511475	8 kom	Karton
	Mini podmazivač R 1/4"	41.350.02	4 006825 581614	R 1/4" unutarnji navoj, R 1/4" vanjski navoj	Plastična ambalaža
	Filter + reduktor tlaka	41.342.00	4 006825 410051	Uklj. spojnica i brza spojnica R 1/4"	Karton
	Filter + reduktor tlaka	41.341.00	4 006825 410044	Uklj. spojnica i brza spojnica R 3/8"	Karton
	Kombinirani filter za održavanje R 1/4" ulje/voda	41.350.01	4 006825 410181	Uklj. podmazivač, spojnica i brza spojnica R 1/4"	Karton
	Kombinirani filter za održavanje R 3/8" ulje/voda	41.350.00	4 006825 410075	Uklj. podmazivač, spojnica i brza spojnica R 3/8"	Karton
	Specijalno ulje za kompresore	41.383.10	4 006825 411270	500 ml	Plastična boca
	Materijal za pjeskarenje	41.383.11	4 006825 663877	1 kg, granulacija 0,2-0,35 mm	Plastična boca

PRIBOR ZA KOMPRESORE					
Ogledna slika	Naziv	Broj artikla	EAN	Karakteristike	Pakiranje
	Michelin priključak, Ø 6 mm	41.393.30	4 006825 588712	Ø 6 mm	Plastična ambalaža
	Brza spojnica ženska, R 1/4" UN	41.392.06	4 006825 410334	R 1/4" unutarnji navoj	Plastična ambalaža
	Brza spojnica ženska, R 1/4" VN	41.392.07	4 006825 560824	R 1/4" vanjski navoj	Plastična ambalaža
	Brza spojnica ženska, R 3/8" UN	41.392.05	4 006825 410327	R 3/8" unutarnji navoj	Plastična ambalaža
	Brza spojnica ženska, R 3/8" VN	41.392.08	4 006825 560831	R 3/8" vanjski navoj	Plastična ambalaža
	Brza spojnica ženska, R 1/2" UN	41.392.10	4 006825 599046	R 1/2" unutarnji navoj	Plastična ambalaža
	Brza spojnica ženska, R 1/2" VN	41.392.09	4 006825 596939	R 1/2" vanjski navoj	Plastična ambalaža
	Brza spojnica ženska za crijevo NW 6 mm	41.393.01	4 006825 581638	Ø 6 mm	Plastična ambalaža
	Brza spojnica ženska za crijevo Ø 9 mm	41.393.02	4 006825 581645	Ø 9 mm	Plastična ambalaža
	Razvodnik zraka R 3/8" IG	41.396.80	4 006825 411713	2 brze spojnice, R 3/8" unutarnji navoj	Plastična ambalaža
	Spojnica muška 6 mm, R 1/4" VN	41.396.65	4 006825 581676	Ø 6 mm, R 1/4" AG	Plastična ambalaža
	Spojnica muška 6 mm, R 3/8" VN	41.396.66	4 006825 581669	Ø 6 mm, R 3/8" AG	Plastična ambalaža
	Spojnica muška 9 mm, R 1/4" VN	41.396.55	4 006825 562347	R 1/4" vanjski navoj	Plastična ambalaža
	Spojnica muška 9 mm, R 3/8" VN	41.396.50	4 006825 411683	R 3/8" vanjski navoj	Plastična ambalaža
	Spojnica muška 9 mm, R 1/4" UN	41.396.40	4 006825 411676	R 1/4" unutarnji navoj	Plastična ambalaža
	Spojnica muška 9 mm, R 3/8" UN	41.396.45	4 006825 581683	R 3/8" unutarnji navoj	Plastična ambalaža
	Spojnica muška 6 mm za crijevo	41.396.60	4 006825 411690	Ø 6 mm	Plastična ambalaža
	Spojnica muška 9 mm za crijevo	41.396.61	4 006825 581621	Ø 9 mm	Plastična ambalaža
	Dvostrani produžetak (nipl) R 1/4" VN	41.396.20	4 006825 411652	R 1/4" vanjski navoj	Plastična ambalaža
	Dvostrani produžetak (nipl) R 3/8" VN	41.396.10	4 006825 411645	R 3/8" vanjski navoj	Plastična ambalaža
	Redukcija R 1/4" UN na R 3/8" VN	41.396.00	4 006825 411621	R 3/8" vanjski navoj na R 1/4" unutarnji navoj	Plastična ambalaža
	Redukcija R 3/8" UN na R 1/2" VN	41.396.05	4 006825 562330	R 1/2" vanjski navoj na R 3/8" unutarnji navoj	Plastična ambalaža
	Redukcija (nipl) s R 1/4" VN na R 3/8" VN	41.396.30	4 006825 411669	R 3/8" vanjski navoj na R 1/4" vanjski navoj	Plastična ambalaža
	Cijev za povezivanje crijeva 6 mm s 2 obujmice	41.393.10	4 006825 411720	Ø 6 mm	Plastična ambalaža
	Cijev za povezivanje crijeva 6 mm s 2 obujmice	41.393.20	4 006825 581652	Ø 9 mm	Plastična ambalaža
	Set brzih spojnica M+Ž za crijevo NW 6 mm s 2 obujmice	41.395.00	4 006825 410136	Ø 6 mm	Plastična ambalaža
	Obujmica za crijevo 8-12 mm, 5/1	41.396.70	4 006825 411706	5 kom, 8 - 12 mm	Plastična ambalaža



PRIMJENA PNEUMATSKIH ALATA I PRIBORA ZA KOMPRESORE

		TE-AC 36/6/8 Li OF Set	TE-AC 36/8 Li OF Set	PRESSITO 18/25 Hybrid	PRESSITO 18/25	PRESSITO	PRESSITO 18/21	TE-AC 50 Silent	TE-AC 24 Silent	TE-AC 6 Silent	TE-AC 430/90/10	TC-AC 420/50/10 V	TC-AC 270/50/8	TE-AC 270/24/10	TE-AC 230/24/8	TC-AC 190/50/8	TC-AC 190/24/8	TC-AC 240/50/10 OF	TC-AC 200/24/8 OF	TC-AC 190/6/8 OF Set	TC-AC 190/6/8 OF	TC-AC 190 OF Set
		40.204.50	40.204.40	40.204.30	40.204.20	40.204.60	40.204.67	40.206.20	40.206.10	40.206.00	40.108.00	40.104.95	40.073.60	40.104.50	40.104.60	40.073.32	40.073.25	40.103.93	40.205.90	40.206.50	40.206.55	40.206.60
TC-PN 50 – Pneumatska klamerica	41.377.90	•	-	-	-	-	-	•	•	•	•	•	•	•	•	•	•	•	•	•	•	-
TC-PW 610 Compact – Pneumatski udarni odvijać	41.389.65	-	-	-	-	-	-	-	-	-	•	•	-	-	-	-	-	-	-	-	-	-
TC-PW 610 – Pneumatski udarni odvijać	41.389.60	-	-	-	-	-	-	-	-	-	•	•	-	-	-	-	-	-	-	-	-	-
TC-PW 340 – Pneumatski udarni odvijać	41.389.50	-	-	-	-	-	-	•	-	-	•	•	•	•	•	-	-	•	-	-	-	-
TC-PP 220 – Pneumatska višenamjenska brusilica	41.385.40	-	-	-	-	-	-	-	-	-	•	•	-	-	-	-	-	-	-	-	-	-
TC-PC 45 – Pneumatski čekić	41.390.40	-	-	-	-	-	-	-	-	-	•	•	-	-	-	-	-	-	-	-	-	-
TC-PC 45 Set – Pneumatski čekić u setu	41.390.45	-	-	-	-	-	-	-	-	-	•	•	-	-	-	-	-	-	-	-	-	-
TC-PR 68 – Pneumatski nasadni odvijać	41.391.80	-	-	-	-	-	-	•	-	-	•	•	•	•	•	-	-	•	-	-	-	-
TC-PE 150 – Pneumatski ekscentrična brusilica	41.333.30	-	-	-	-	-	-	-	-	-	•	•	-	-	-	-	-	-	-	-	-	-
Pištolj za ispuhivanje sa 4 mlaznice	41.327.62	•	•	-	-	-	-	•	•	•	•	•	•	•	•	•	•	•	•	•	•	•
Pištolj za ispuhivanje s 500 mm mlaznicom	41.327.63	•	•	-	-	-	-	•	•	•	•	•	•	•	•	•	•	•	•	•	•	•
2 smjerni pištolj za ispuhivanje	41.332.10	•	•	-	-	-	-	•	•	•	•	•	•	•	•	•	•	•	•	•	•	•
Pištolj za ispuhivanje, dugi	41.331.02	•	•	-	-	-	-	•	•	•	•	•	•	•	•	•	•	•	•	•	•	•
Pištolj za ispuhivanje, kratki	41.331.00	•	•	-	-	-	-	•	•	•	•	•	•	•	•	•	•	•	•	•	•	•
Pištolj za ispuhivanje u setu	41.327.59	•	•	-	-	-	-	•	•	•	•	•	•	•	•	•	•	•	•	•	•	•
Nastavak za pumpanje guma s digitalnim manometrom	41.331.15	•	•	-	-	-	-	•	•	•	•	•	•	•	•	•	•	•	•	•	•	•
Profi nastavak za pumpanje guma s manometrom	41.331.10	•	•	-	-	-	-	•	•	•	•	•	•	•	•	•	•	•	•	•	•	•
Nastavak za pumpanje guma s manometrom	41.370.00	•	•	-	-	-	-	•	•	•	•	•	•	•	•	•	•	•	•	•	•	•
Profi pištolj za boju s plastičnom posudom, 0,6 l	41.330.30	-	-	-	-	-	-	•	-	-	•	•	•	•	•	-	-	•	-	-	-	-
Pištolj za boju s plastičnom posudom, 0,6 l	41.330.00	-	-	-	-	-	-	•	-	-	•	•	•	•	•	-	-	•	-	-	-	-
Pištolj za boju s metalnom posudom, 1 l	41.329.00	-	-	-	-	-	-	•	-	-	•	•	•	•	•	-	-	•	-	-	-	-
Pištolj za raspršivanje	41.332.00	-	-	-	-	-	-	•	-	-	•	•	•	•	•	-	-	•	-	-	-	-
Pištolj za pjeskarenje s metalnom posudom	41.333.00	-	-	-	-	-	-	-	-	-	•	•	-	-	-	-	-	-	-	-	-	-
Usisni pištolj za pjeskarenje	41.334.20	-	-	-	-	-	-	-	-	-	•	•	-	-	-	-	-	-	-	-	-	-
Pištolj za podnu zaštitu	41.335.01	-	-	-	-	-	-	•	-	-	•	•	•	•	•	-	-	•	-	-	-	-
Set za kompresor, 13/1	41.327.76	-	-	-	-	-	-	-	-	-	•	•	-	-	-	-	-	-	-	-	-	-
Set za kompresor, 10/1	40.205.77	-	-	-	-	-	-	•	-	-	•	•	•	•	•	-	-	•	-	-	-	-
Profi set za kompresor, 5/1	41.327.20	-	-	-	-	-	-	•	-	-	•	•	•	•	•	-	-	•	-	-	-	-
Set za kompresor, 3/1	41.327.41	•	•	-	-	-	-	•	•	•	•	•	•	•	•	•	•	•	•	•	•	•

• Moguća upotreba

- Upotreba nije moguća

PRIBOR ZA STOLNE BRUSILICE

	Naziv	Broj artikla	EAN	Ø	Ø Provrt	Debljina ploče	Granulacija	Redukcijski prstenovi
	Polirna ploča	49507045	4 009315 070452	75 mm	10 mm	20 mm	400	–
	Brusna ploča	49507125	4 009315 071251	75 mm	10 mm	20 mm	120	–
	Brusna ploča	49507465	4 009315 074658	150 mm	32 mm	16 mm	60	12,7 mm
	Brusna ploča	49507435	4 009315 074351	150 mm	32 mm	16 mm	36	12,7 mm
	Brusna ploča	49507565	4 009315 075655	150 mm	32 mm	20 mm	60	12,7 mm
	Brusna ploča	49507535	4 009315 075358	150 mm	32 mm	20 mm	36	12,7 mm
	Brusna ploča	49507885	4 009315 078854	200 mm	20 mm	40 mm	200	–
	Brusna ploča	49507765	4 009315 077659	200 mm	32 mm	25 mm	60	16 mm
	Brusna ploča	49507735	4 009315 077352	200 mm	32 mm	25 mm	36	16 mm
	Brusna četka za TC-BG 150 B	44.126.36	4 006825 670882	150 mm	32 mm	–	–	12,7 mm

PRIBOR ZA STOLNE BRUSILICE I ALATE ZA BRUŠENJE I GRAVIRANJE

	Naziv	Broj artikla	EAN	Opseg isporuke	Odgovara za	Pakiranje
	Set pribora za brušenje i graviranje	49510951	4 009315 109510	38 kom	Alati za brušenje i graviranje i stolne brusilice	Plastični kovčeg

PRIBOR ZA STOLNE BRUSILICE MOKRO

	Naziv	Broj artikla	EAN	Karakteristike
	Kožna brusna ploča	49507886	4 009315 078861	Ø 180 mm, Ø provrt 12,7 mm, debljina ploče 30 mm

PRIBOR ZA STOLNE BRUSILICE MOKRO

	Naziv	Broj artikla	EAN	Odgovara za
	Uređaj za obradu brusnih ploča	44.180.12	4 006825 667448	Ravno obrađivanje brusnih ploča
	Uređaj za oštrenje kratkih noževa	44.180.13	4 006825 667455	Oštrenje kratkih noževa (oštrice 4 - 10 cm)
	Uređaj za oštrenje dugih noževa	44.180.14	4 006825 667462	Oštrenje dugih i fleksibilnih noževa (oštrice 10 - 20 cm)
	Uređaj za tokarenje žljebova	44.180.15	4 006825 667479	Brušenje alata za rezbarenje i tokarskih žljebova

PRIBOR ZA STOLNE TRAČNE BRUSILICE

	Naziv	Broj artikla	EAN	Dimenzije	Količina	Granulacija
	Set brusnih traka	49910805	4 009319 108052	686 x 50 mm	5 kom	2x P60, 2x P80, 1x P120
	Set brusnih traka	49914605	4 009319 146054	914 x 100 mm	3 kom	1x P60, 1x P80, 1x P120
	Set brusnih papira	49492074	4 009314 920741	Ø 150 mm	3 kom	P80

PRIBOR ZA PREKLOPNE PILE ZA METAL

	Naziv	Broj artikla	EAN	Vanjski promjer Ø	Ø Provrt	Debljina
	Rezna ploča	49791975	4 009317 919759	355 mm	25,4 mm	3,2 mm

PRIBOR ZA STUPNE BUŠILICE

	Naziv	Broj artikla	EAN	Širina čeljusti	Raspon	Razmak rupa za pričvršćivanje
	Škripac za stupne bušilice, 80 mm	49777015	4 009317 770152	80 mm	maks. 68 mm	85 mm od centra do centra

PRIBOR ZA STROJEVE ZA REZANJE PLOČICA I KAMENA

	Naziv	Broj artikla	EAN	Ø	Ø Provrt	Oblik ruba
	Dijamantna rezna ploča, puni rub, 180x25,4 mm, za TC-TC 800	49795850	4 009317 958505	180 mm	25,4 mm	Puni rub
	Dijamantna rezna ploča, puni rub, 200x25,4 mm, za TE-TC 620 U	49795855	4 009317 958550	200 mm	25,4 mm	Puni rub
	Dijamantna rezna ploča turbo 180x25,4 mm, za TC-TC 800	49797650	4 009317 976509	180 mm	25,4 mm	Turbo
	Dijamantna rezna ploča turbo 200x25,4 mm, za TE-TC 620 U	49797750	4 009317 977506	200 mm	25,4 mm	Turbo
	Dijamantna rezna ploča turbo 250x25,4 mm, za TE-SC 570 L	49797851	4 009317 978510	250 mm	25,4 mm	Turbo
	Dijamantna rezna ploča turbo 300x25,4 mm, za TE-SC 920 L	49797950	4 009317 979500	300 mm	25,4 mm	Turbo

PRIBOR BENZINSKE UREĐAJE

	Naziv	Broj artikla	EAN	Duljina usisnog crijeva	Kapacitet spremnika
	Pumpa za benzin i ulje	34.070.00	4 006825 547276	1,3 m	1,6 l



NJEGA TRAVNJAKA I TLA



ROBOTSKA KOSILICA



PURE POWER
BRUSHLESS



	GC-RM 500 Brushless CLASSIC
PXC baterija napon / kapacitet	28 V / 2,0 Ah
Preporučeno za travnjake do cca. do cca.*	500 m ²
Širina košnje	18 cm
Podešavanje visine košnje	Beskonačno / 20 - 60 mm / centralno
Maksimalni nagib	35%
Senzori za udarce, podizanje i nagib	•
Motor bez četkica	•
Integrirana ručka za nošenje	•
Broj baterija / punjača	1 / 1
Uključena granična žica	130 m
Uključene kuke za pričvršćivanje	190 kom
Uključeni pribor	4 spojnice, 3 zamjenske oštrice
Broj artikla	34.139.30

* Navedena pokrivenost područja temelji se na pretpostavci idealnih uvjeta



PRIBOR ZA ROBOTSKE KOSILICE S GRANIČNOM ŽICOM

		Broj artikla	EAN	Opseg isporuke	Pogodno za
	Garaža za Freelexo robotsku kosilicu	34.140.24	4 006825 654417	1 kom (sklopiva, DxŠxV: 77x59x39,5 cm)	Sve Einhell robotske kosilice
	Granična žica za robotsku kosilicu, 50 m	34.140.21	4 006825 648782	1 kom (50 m)	
	Rezervni nožići za robotsku kosilicu, 12/1	34.140.20	4 006825 648775	12 kom	
	Klin za pričvršćivanje granične žice za robotsku kosilicu, 100/1	34.140.23	4 006825 648805	100 kom	
	Spojne stezaljke za robotsku kosilicu, 4/1	34.140.22	4 006825 648799	4 kom	
	Set za popravak za robotsku kosilicu	34.140.26	4 006825 657968	5 m granične žice, 15 kom kuke za pričvršćivanje, 8 kom spojnice	
	Set za čišćenje za robotsku kosilicu	34.140.25	4 006825 657951	Rukavice, četke, brusne ploče, krpa od mikrovlakana, lopatica, odvijač	

ELEKTRIČNE KOSILICE



	GC-EM 1700/42 CLASSIC	GC-EM 1500/36 CLASSIC	GC-EM 1000/30 CLASSIC
Napon / snaga	230 - 240 V ~ 50 Hz / 1700 W	220 - 240 V ~ 50 Hz / 1500 W	220 - 240 V ~ 50 Hz / 1000 W
Širina košnje	42 cm	36 cm	30 cm
Podešavanje visine košnje	6 postavki / 20 - 65 mm / centralno	5 postavki / 25 - 65 mm / centralno	3 postavke / 30 - 70 mm / osovinsko
Kapacitet košare za travu	50 l	38 l	25 l
Promjer kotača prednji / stražnji	150 mm / 230 mm	140 mm / 200 mm	140 mm / 140 mm
Materijal kućišta	Plastika	Plastika	Plastika
Preporučeno za travnjake do cca.	700 m ²	600 m ²	300 m ²
Težina proizvoda	11,8 kg	10,0 kg	7,2 kg
Malčiranje	-	-	-
Visoki kotači	•	•	-
Integrirana ručka za nošenje	•	•	•
Kopča za rasterećenje kabela	•	•	•
Ručka podesiva po visini	•	•	-
Sklopiva ručka	•	•	•
Funkcija brzog stezanja ručke	•	•	-
Košara za travu s indikatorom	•	•	-
Široki kotači za manje pritiska na travu	•	•	•
Broj artikla	34.001.60	34.001.56	34.001.22



4 006825 595338



4 006825 662665



4 006825 602555

ELEKTRIČNE KOSILICE



	GC-EM 1743 HW CLASSIC	GC-EM 1437 CLASSIC	GC-EM 1032 CLASSIC
Napon / snaga	230 V ~ 50 Hz / 1700 W	230 V ~ 50 Hz / 1400 W	220 - 240 V ~ 50 Hz / 1000 W
Širina košnje	43 cm	37 cm	32 cm
Podešavanje visine košnje	6 postavki / 20 - 70 mm / centralno	3 postavke / 25 - 60 mm / osovinsko	3 postavke / 20 - 60 mm / pojedinačno
Kapacitet košare za travu	52 l	36 l	30 l
Promjer kotača prednji / stražnji	170 mm / 235 mm	140 mm / 170 mm	140 mm / 140 mm
Materijal kućišta	Plastika	Plastika	Plastika
Preporučeno za travnjake do cca.	700 m ²	500 m ²	300 m ²
Težina proizvoda	13,7 kg	9,3 kg	9,2 kg
Malčiranje	-	-	-
Visoki kotači	•	-	-
Integrirana ručka za nošenje	•	•	•
Kopča za rasterećenje kabela	•	•	•
Ručka podesiva po visini	•	•	•
Sklopiva ručka	•	•	•
Funkcija brzog stezanja ručke	-	-	-
Košara za travu s indikatorom	•	-	•
Široki kotači za manje pritiska na travu	•	•	•
Broj artikla	34.005.90	34.002.85	34.002.57



4 006825 572940



4 006825 574043



4 006825 646498

BENZINSKE KOSILICE



Benzinska kosilica
GC-PM 56/2 S HW

INDIKATOR
NAPUNJENOSTI KOŠARE

CENTRALNO PODEŠAVANJE
VISINE KOŠNJE

Praktično podešavanje
visine košnje

BOČNO IZBACIVANJE

FUNKCIJA MALČIRANJA

FUNKCIJA
STRAŽNJEG IZBACIVANJA

Stražnje izbacivanje bez košare
za maksimalnu visinu trave

POLOŽAJ ZA ČIŠĆENJE

Mogućnost uspravnog
postavljanja kosilice za
praktično čišćenje

VORTEX TEHNOLOGIJA

Posebno kućište optimizirano za
protok sa savršenim karakteristikama
košnje i hvatanja trave

BENZINSKA KOSILICA



	GC-PM 56/2 S HW CLASSIC	GC-PM 52/2 S HW CLASSIC
Motor / obujam motora	4-taktni / 173 cm ³	4-taktni / 173 cm ³
Snaga / radna brzina	2,8 kW / 2850 min ⁻¹	2,8 kW / 2850 min ⁻¹
Širina košnje	56 cm	52 cm
Podešavanje visine košnje	6 postavki / 25 - 70 mm / centralno	6 postavki / 25 - 70 mm / centralno
Kapacitet košare za travu	80 l	80 l
Promjer kotača prednji / stražnji	200 mm / 280 mm	200 mm / 280 mm
Materijal kućišta	Plastificirani čelični lim	Plastificirani čelični lim
Preporučeno za travnjake do cca.	2200 m ²	1800 m ²
Težina proizvoda	38,3 kg	37,3 kg
5-u-1 funkcija	•	•
Visoki kotači	•	•
Samohodna	•	•
Češalj za travu i ugrađena ručka za nošenje	•	•
Položaj za čišćenje i skladištenje	•	•
Vortex tehnologija	•	•
Ručka podesiva po visini	•	•
Sklopiva ručka	•	•
Košara za travu s indikatorom	•	•
Alat za čišćenje	•	•
Broj artikla	34.048.60	34.048.50



BENZINSKE KOSILICE S PXC E-STARTOM



	GC-PM 51/3 S HW-E Li CLASSIC	GC-PM 46 SM HW-E Li CLASSIC
Motor / obujam motora	4-taktni / 170 cm ³	4-taktni / 146 cm ³
Snaga / radna brzina	2,7 kW / 2900 min ⁻¹	2,0 kW / 2900 min ⁻¹
PXC baterija napon / kapacitet	1x 18 V / 2,0 Ah	1x 18 V / 2,0 Ah
Vrijeme punjenja	2,5 h	2,5 h
Širina košnje	51 cm	46 cm
Podšavanje visine košnje	6 postavki / 30 - 80 mm / centralno	9 postavki / 25 - 80 mm / centralno
Kapacitet košare za travu	70 l	65 l
Promjer kotača prednji / stražnji	204 mm / 280 mm	204 mm / 280 mm
Materijal kućišta	Plastificirani čelični lim	Plastificirani čelični lim
Preporučeno za travnjake do cca.	1800 m ²	1400 m ²
Težina proizvoda	34,8 kg	32,1 kg
Visoki kotači	•	•
Samohodna	•	•
Elektro paljenje s Power X-Change baterijom (18 V)	•	•
Malčiranje	•	•
Ručka podesiva po visini s mekim rukohvatom	•	•
Košara za travu s indikatorom	•	•
Češalj za travu	-	•
Broj baterija / punjača	1 / 1	1 / 1
Broj artikla	34.048.70	34.075.60



4 006825 655285



4 006825 662054

EINHELL VORTEX TEHNOLOGIJA

Metalno kućište kosilice posebno je dizajnirano za optimalan protok zraka. Zahvaljujući posebnom obliku, rotirajući nož stvara snažno usisavanje koje uspravlja travu prije nego što se pokosi. Tek tada se reže, a zatim usitnjava velikom snagom u optimiziranom protoku zraka i nakon toga izbacuje.



BUJNIJI TRAVNJAK ZAHVALJUJUĆI MALČIRANJU

Mnoge Einhell kosilice mogu se pretvoriti u kosilicu za malčiranje postavljanjem adaptera za malčiranje.

Trava se usitnjava nekoliko puta i ostaje na travnjaku gdje se brzo pretvara u kompost.

Time se travnjak gnoji, smanjujući isparavanje. To štiti travnjak od isušivanja i stvara idealne uvjete za život mikroba koji osiguravaju poboljšanje svojstava tla.

Treba paziti da duljinu stabljika skratite najviše za trećinu. Reznice će se usitniti učinkovitije i kao rezultat toga pasti ravno na tlo, tako da manje smetaju prilikom korištenja travnjaka. Također doprinosi formiranju bočnih izdanaka u travnjaku. Travnjak postaje gušći i zeleniji.



BENZINSKA KOSILICA



	GC-PM 46 S HW-E CLASSIC
Motor / obujam motora	4-taktni / 146 cm ³
Snaga / radna brzina	2,0 kW / 2900 min ⁻¹
Širina košnje	46 cm
Podešavanje visine košnje	9 postavki / 25 - 80 mm / centralno
Kapacitet košare za travu	65 l
Promjer kotača prednji / stražnji	204 mm / 280 mm
Materijal kućišta	Plastificirani čelični lim
Preporučeno za travnjake do cca.	1400 m ²
Težina proizvoda	33,5 kg
Bočno izbacivanje	-
Malčiranje	-
Visoki kotači	•
Samohodna	•
Elektro paljenje	•
Češalj za travu	•
Ručka podesiva po visini	•
Sklopiva ručka	•
Košara za travu s indikatorom	•
Broj artikla	34.075.70



BENZINSKA KOSILICA



	GC-PM 51/3 S HW CLASSIC
Motor / obujam motora	4-taktni / 170 cm ³
Snaga / radna brzina	2,7 kW / 2900 min ⁻¹
Širina košnje	51 cm
Podešavanje visine košnje	6 postavki / 30 - 80 mm / centralno
Kapacitet košare za travu	70 l
Promjer kotača prednji / stražnji	204 mm / 280 mm
Materijal kućišta	Plastificirani čelični lim
Preporučeno za travnjake do cca.	1800 m ²
Težina proizvoda	31,4 kg
Bočno izbacivanje	•
Malčiranje	•
Visoki kotači	•
Samohodna	•
Elektro paljenje	-
Ručka podesiva po visini	•
Sklopiva ručka	•
Košara za travu s indikatorom	•
Broj artikla	34.043.33



PRIBOR ZA BENZINSKE KOSILICE



	Sprej za brzo paljenje ACCESSORY
Pogodno za	Benzinska kosilica
Broj artikla	34.030.98



BENZINSKE KOSILICE



	GC-PM 46/5 S CLASSIC	GC-PM 46/3 CLASSIC
Motor / obujam motora	4-taktni / 132 cm ³	4-taktni / 132 cm ³
Snaga / radna brzina	2,0 kW / 2900 min ⁻¹	2,0 kW / 2900 min ⁻¹
Širina košnje	46 cm	46 cm
Podešavanje visine košnje	9 postavki / 25 - 80 mm / centralno	9 postavki / 25 - 80 mm / centralno
Kapacitet košare za travu	65 l	65 l
Promjer kotača prednji / stražnji	178 mm / 204 mm	178 mm / 204 mm
Materijal kućišta	Plastificirani čelični lim	Plastificirani čelični lim
Preporučeno za travnjake do cca.	1400 m ²	1200 m ²
Težina proizvoda	26,0 kg	23,0 kg
Malčiranje	-	-
Samohodna	•	-
Ručka podesiva po visini	•	•
Sklopiva ručka	•	•
Košara za travu s indikatorom	•	•
Broj artikla	34.075.50	34.075.40



4 006825 662047



4 006825 662436

BENZINSKE KOSILICE



	GC-PM 40/2 S CLASSIC	GC-PM 40/2 CLASSIC
Motor / obujam motora	4-taktni / 132 cm ³	4-taktni / 132 cm ³
Snaga / radna brzina	2,0 kW / 2900 min ⁻¹	2,0 kW / 2900 min ⁻¹
Širina košnje	40 cm	40 cm
Podešavanje visine košnje	7 postavki / 25 - 75 mm / centralno	3 postavke / 25 - 60 mm / pojedinačno
Kapacitet košare za travu	45 l	45 l
Promjer kotača prednji / stražnji	178 mm / 203 mm	152 mm / 152 mm
Materijal kućišta	Plastika	Plastika
Preporučeno za travnjake do cca.	1000 m ²	800 m ²
Težina proizvoda	19,9 kg	17,3 kg
Malčiranje	-	-
Samohodna	•	-
Ručka podesiva po visini	-	-
Sklopiva ručka	•	•
Košara za travu s indikatorom	•	•
Broj artikla	34.048.23	34.048.33



4 006825 665260



4 006825 665741

RUČNE KOSILICE

DUGAČKA RUČKA

Ergonomski oblikovana i opremljena mekim rukohvatom za savršeno rukovanje

RUČKA PODESIVA PO VISINI

Optimalna prilagodba visini korisnika

OSOVINA ZA KOŠNJU S KUGLIČNIM LEŽAJEM

5 visokokvalitetnih, precizno brušenih čeličnih noževa za savršen rezultat košnje

KOŠARA ZA TRAVU

Košara za travu od 26 l koja se može odstraniti

Ručna kosilica
GE-HM 38 S-F

TIHA I ŠTEDLJIVA

Tehnologija beskontaktnog rezanja smanjuje napor i vrlo je tiha

PODEŠAVANJE VISINE KOŠNJE

4 postavke omogućuju preciznu košnju

RUČNA KOSILICA



	GE-HM 38 S-F EXPERT
Širina košnje	38 cm
Podešavanje visine košnje	4 postavke / 13 - 38 mm
Kapacitet košare za travu	26 l
Broj noževa	5
Osovina za košnju promjer	125 mm
Promjer kotača	220 mm
Preporučeno za travnjake do cca.	250 m ²
Težina proizvoda	8,4 kg
Široki kotači za manje pritiska na travu	•
Pozicija parkiranja	•
Ručka podesiva po visini	•
Beskontaktna	•
Košara za travu	•
Broj artikla	34.141.61



4 006825 607765

RUČNA KOSILICA



	GE-HM 38 S EXPERT
Širina košnje	38 cm
Podešavanje visine košnje	4 postavke / 13 - 38 mm
Kapacitet košare za travu	-
Broj noževa	5
Osovina za košnju promjer	125 mm
Promjer kotača	220 mm
Preporučeno za travnjake do cca.	250 m ²
Težina proizvoda	7,8 kg
Široki kotači za manje pritiska na travu	•
Pozicija parkiranja	•
Ručka podesiva po visini	•
Beskontaktna	•
Košara za travu	-
Broj artikla	34.141.65



4 006825 609714

RUČNE KOSILICE



	GC-HM 400 CLASSIC	GC-HM 300 CLASSIC
Širina košnje	40 cm	30 cm
Podešavanje visine košnje	4 postavke / 13 - 37 mm	4 postavke / 13 - 37 mm
Kapacitet košare za travu	27 l	16 l
Broj noževa	5	5
Osovina za košnju promjer	125 mm	125 mm
Promjer kotača	215 mm	215 mm
Preporučeno za travnjake do cca.	250 m ²	150 m ²
Težina proizvoda	7,5 kg	6,5 kg
Široki kotači za manje pritiska na travu	•	•
Pozicija parkiranja	•	•
Ručka podesiva po visini	-	-
Beskontaktna	-	-
Broj artikla	34.141.29	34.141.14



4 006825 651959



4 006825 651942

ELEKTRIČNI PROZRAČIVAČI TRAVE

SKLOPIVA RUČKA

Sklopiva dugačka ručka s funkcijom brzog stezanja omogućuje brzo spremanje koje štedi prostor

RUČKA ZA NOŠENJE

Jednostavan transport zahvaljujući ergonomskoj ručki za nošenje

CENTRALNO PODEŠAVANJE RADNE DUBINE

Jednostavno i praktično podešavanje željene radne dubine

BRZA IZMJENA ALATA

Valjci za skarifikaciju i prozračivanje mogu se brzo promijeniti pomoću isporučenog alata

KOŠARA ZA TRAVU

Uz veliku košaru za sakupljanje trave, bez problema su mogući i dulji radni zadaci



Električni prozračivač trave
GE-SA 1640

ELEKTRIČNI PROZRAČIVAČI TRAVE



	GE-SA 1640 EXPERT	GE-SA 1435/1 EXPERT NOVO
Napon / snaga	230 V ~ 50 Hz / 1600 W	230 V ~ 50 Hz / 1400 W
Radna širina	400 mm	350 mm
Podešavanje dubine rada	4 postavke (centralno) + transportna pozicija	3 postavke + transportna pozicija
Broj oštrica (kuglični ležaji)	20 kom	16 kom
Broj kandži za prozračivanje (kuglični ležaji)	30 kom	24 kom
Promjer kotača prednji / stražnji	220 mm / 175 mm	160 mm / 160 mm
Materijal kućišta	Plastika	Plastika
Preporučeno za travnjake do cca.	800 m ²	550 m ²
Težina proizvoda	13,7 kg	10,2 kg
Integrirana ručka za nošenje	•	•
Ručka podesiva po visini + pozicija parkiranja	•	•
Sklopiva ručka	•	•
Brzo pričvršćivanje ručke	•	•
Široki kotači za manje pritiska na travu	•	•
Promjena valjka bez alata	-	•
Košara za travu	•	•
Valjak za prozračivanje i valjak za skarifikaciju	•	•
Broj artikla	34.205.90	34.206.90



ELEKTRIČNI PROZRAČIVAČI TRAVE



	GC-SA 1231/1 CLASSIC	GC-ES 1231/1 CLASSIC
Napon / snaga	230 V - 50 Hz / 1200 W	230 V - 50 Hz / 1200 W
Radna širina	310 mm	310 mm
Podešavanje dubine rađa	3 postavke + transportna pozicija	3 postavke + transportna pozicija
Broj oštrica (kuglični ležaji)	8 kom dvostruki nož	8 kom dvostruki nož
Broj kandži za prozračivanje (kuglični ležaji)	45 kom	-
Promjer kotača prednji / stražnji	180 mm / 100 mm	180 mm / 100 mm
Materijal kućišta	Plastika	Plastika
Preporučeno za travnjake do cca.	300 m ²	300 m ²
Težina proizvoda	8,5 kg	8,0 kg
Integrirana ručka za nošenje	•	•
Ručka podesiva po visini	•	•
Sklopiva ručka	•	•
Brzo pričvršćivanje ručke	-	-
Široki kotači za manje pritiska na travu	•	•
Košara za travu	•	-
Valjak za skarifikaciju	•	•
Valjak za prozračivanje	•	-
Broj artikla	34.206.40	34.206.30



4 006825 628272



4 006825 628289

BENZINSKI PROZRAČIVAČ TRAVE



	GC-SC 4240 P CLASSIC
Motor / obujam motora	4-taktni / 212 cm ³
Snaga	4,2 kW
Radna širina	400 mm
Podešavanje dubine rađa	8 postavki (centralno) + transportna pozicija
Broj oštrica (kuglični ležaji)	18 kom
Promjer kotača prednji / stražnji	180 mm / 180 mm
Materijal kućišta	Metal
Preporučeno za travnjake do cca.	1200 m ²
Težina proizvoda	31,4 kg
Sklopiva ručka	•
Široki kotači za manje pritiska na travu	•
Košara za travu	•
Valjak za skarifikaciju	•
Broj artikla	34.200.19



4 006825 638073

VALJAK ZA TRAVU



	GC-GR 57 CLASSIC
Radna širina	57 cm
Promjer valjka	32 cm
Maks. kapacitet punjenja	46 l
Materijal kućišta	Lakirani metal
Težina proizvoda	10,5 kg
Može se napuniti pijeskom	•
Može se napuniti vodom	•
Broj artikla	34.153.02



4 006825 627404

ELEKTRIČNI UREĐAJ ZA ČIŠĆENJE FUGA



	GC-EG 1410 CLASSIC
Napon / snaga	230 - 240 V ~ 50 Hz / 140 W
Promjer četke	100 mm
Materijal kućišta	Plastika
Težina proizvoda	1,5 kg
Kotač za vođenje	•
Kopča za rasterećenje kabela	•
Čelična četka (15 mm dužine)	•
Čelična četka (10 mm dužine)	- (dostupno kao dodatna oprema)
Najlonska četka (10 mm dužine)	•
Najlonska četka (6 mm dužine)	- (dostupno kao dodatna oprema)
Broj artikla	34.240.02



4 006825 627411

KOLICA ZA SIJANJE TRAVE



	GC-SR 12 CLASSIC
Širina sijanja	45 cm
Kapacitet posude za sijanje	12 l
Promjer kotača	200 mm
Težina proizvoda	2,5 kg
Dvostruka ručka	•
Podešavanje volumena sijanja	•
Valjak otporan na prohrđavanje	•
Opružna brava za demontažu bez dodatnog alata	•
Broj artikla	34.152.38



4 006825 635065

ELEKTRIČNI TRIMER ZA TRAVU



GC-ET 4530 Set	
CLASSIC	
Napon / snaga	230 V - 50 Hz / 450 W
Širina rezanja	300 mm
Rezna nit promjer / duljina	1,4 mm / 1000 cm
Jednostrana / dvostrana špula s reznom niti	Dvostrana špula
Materijal kućišta	Plastika
Težina proizvoda	2,6 kg
Dodatna ručka	•
Teleskopska duga drška	•
Kopča za rasterećenje kabela	•
Okretna glava motora	180°
Nagibna glava motora	4 pozicije
Štitnik za cvijeće	•
Automatsko izvlačenje rezne niti	-
Potpuno automatsko izvlačenje rezne niti	•
Rubni valjak	-
Špula s reznom niti	• (3 kom)
Broj artikla	34.020.22



4 006825 610505

ELEKTRIČNI TRIMERI ZA TRAVU



GC-ET 3023		GC-ET 2522	
CLASSIC		CLASSIC	
Napon / snaga	230 V - 50 Hz / 300 W	230 - 240 V - 50 Hz / 250 W	
Širina rezanja	230 mm	220 mm	
Rezna nit promjer / duljina	1,5 mm / 600 cm	1,2 mm / 600 cm	
Jednostrana / dvostrana špula s reznom niti	Jednostrana špula	Dvostrana špula	
Materijal kućišta	Plastika	Plastika	
Težina proizvoda	1,5 kg	1,1 kg	
Dodatna ručka	•	•	
Teleskopska duga drška	-	-	
Kopča za rasterećenje kabela	•	•	
Okretna glava motora	-	-	
Nagibna glava motora	-	-	
Štitnik za cvijeće	-	-	
Automatsko izvlačenje rezne niti	•	•	
Potpuno automatsko izvlačenje rezne niti	-	-	
Rubni valjak	-	-	
Špula s reznom niti	•	•	
Broj artikla	34.020.50	34.020.40	



4 006825 598162



4 006825 616699

BENZINSKI TRIMER ZA TRAVU



	GC-PT 2538/1 I AS CLASSIC
Motor / obujam motora	2-taktni / 25,4 cm ³
Snaga	0,6 kW
Širina rezanja dvostrana rezna nit	380 mm
Rezna nit promjer / duljina	2 mm / 400 cm
Jednostrana / dvostrana špula s reznom niti	Dvostrana špula
Materijal kućišta	Plastika
Težina proizvoda	5,5 kg
Ukošena aluminijska drška	•
Odvojiva osovina	•
Brzo paljenje	•
Automatski čok	•
Centrifugalna spojka za rezni alat	•
Automatsko izvlačenje rezne niti	•
Broj artikla	34.019.38



4 006825 643800

BENZINSKI VIŠENAMJENSKI VRTNI ALAT

 FITTED WITH
OREGON
 CHAIN AND BAR

	GC-MM 52 I AS CLASSIC
Motor / obujam motora	2-taktni / 51,7 cm ³
Snaga	1,5 kW
Širina rezanja rezna nit	420 mm
Rezna nit promjer / duljina	2,4 mm / 400 cm
Širina rezanja nož	255 mm
Lančana pila duljina reza	255 mm
Lančana pila brzina reza	21,3 m/s
Škare za živicu duljina reza	395 mm
Škare za živicu razmak zuba	31 mm
Maksimalna radna visina	3,5 m (lančana pila) / 3,5 m (škare za živicu)
Nastavak teleskopske drške	•
Aluminijska drška	•
Odvojiva osovina	•
Automatski čok	•
Digitalno paljenje	•
Automatsko izvlačenje rezne niti	•
Nagibni nastavak škara za živicu	•
OREGON kvalitetni mač i lanac	•
Automatsko podmazivanje lanca	•
Podesiva dodatna ručka	•
Štitnik	•
Remen za nošenje s brzim otpuštanjem	•
Broj artikla	34.365.55



4 006825 641684

PRIBOR ZA BENZINSKE UREĐAJE



	Pumpa za benzin i ulje ACCESSORY
Duljina usisnog crijeva	1,3 m
Kapacitet spremnika	1,6 l
Broj artikla	34.070.00



4 006825 547276

BENZINSKI TRIMERI ZA TRAVU



4-TAKTNI MOTOR

Visokokvalitetan, moderan 4-taktni motor s niskim vibracijama

DVOSTRANA RUČKA

Univerzalno podesiva aluminijska dvostrana ručka s integriranim kontrolama omogućuje ergonomski rad s najvećom mogućom kontrolom

ODVOJIVA OSOVINA

Jednostavan sustav pričvršćivanja za brzu pohranu koja štedi prostor

ALUMINIJSKA OSOVINA

Mala težina - jednostavan rad

Benzinski trimer za travu
GC-BC 36-4 S

UDOBAN REMEN

Uključen remen za nošenje za udoban i zahtjevan rad

BENZINSKI TRIMER ZA TRAVU



	GC-BC 36-4 S CLASSIC
Motor / obujam motora	4-taktni / 37,7 cm ³
Snaga	1,0 kW
Širina rezanja rezna nit	420 mm
Rezna nit promjer / duljina	2,4 mm / 400 cm
Širina rezanja nož	255 mm
Materijal kućišta	Aluminij / plastika
Težina proizvoda	7,9 kg
Drška sa svim potrebnim kontrolama	•
Aluminijska ručka	•
Odvojiva osovina	•
Brzo paljenje	•
Automatski čok	-
Digitalno paljenje – stabilan rad motora	•
Automatsko izvlačenje rezne niti	•
Pojas za nošenje	•
Nož + špula s reznom niti	•
Broj artikla	34.365.60



4 006825 648751

BENZINSKI TRIMERI ZA TRAVU



	GC-BC 52 I AS CLASSIC	GH-BC 43 AS CLASSIC
Motor / obujam motora	2-taktni / 51,7 cm ³	2-taktni / 42,7 cm ³
Snaga	1,5 kW	1,25 kW
Širina rezanja rezna nit	420 mm	420 mm
Rezna nit promjer / duljina	2,4 mm / 400 cm	2,4 mm / 400 cm
Širina rezanja nož	255 mm	255 mm
Materijal kućišta	Aluminij / plastika	Aluminij / plastika
Težina proizvoda	8,5 kg	8,9 kg
Drška sa svim potrebnim kontrolama	•	•
Aluminijska ručka	•	•
Odvojiva osovina	•	•
Brzo paljenje + automatski čok	•	•
Digitalno paljenje – stabilan rad motora	•	•
Automatsko izvlačenje rezne niti	•	•
Pojas za nošenje	•	•
Nož + špula s reznom niti	•	•
Broj artikla	34.365.40	34.019.73



4 006825 617337



4 006825 594768

BENZINSKI TRIMERI ZA TRAVU



	GC-BC 30/1 I AS CLASSIC	GC-BC 25/1 I AS CLASSIC
Motor / obujam motora	2-taktni / 29,7 cm ³	2-taktni / 25,4 cm ³
Snaga	1,0 kW	0,6 kW
Širina rezanja rezna nit	420 mm	420 mm
Rezna nit promjer / duljina	2,0 mm / 400 cm	2,0 mm / 400 cm
Širina rezanja nož	230 mm	230 mm
Materijal kućišta	Aluminij / plastika	Aluminij / plastika
Težina proizvoda	7,6 kg	6,3 kg
Drška sa svim potrebnim kontrolama	•	•
Aluminijska ručka	•	•
Odvojiva osovina	•	•
Brzo paljenje + automatski čok	•	•
Digitalno paljenje – stabilan rad motora	•	•
Automatsko izvlačenje rezne niti	•	•
Pojas za nošenje	•	•
Nož + špula s reznom niti	•	•
Broj artikla	34.365.25	34.019.57



4 006825 649086



4 006825 643824

BENZINSKE KOPAČICE



	GC-MT 4280 CLASSIC	GC-MT 2560 LD CLASSIC
Motor / obujam motora	4-taktni / 212 cm ³	4-taktni / 150 cm ³
Snaga / radna brzina	4,1 kW / 3600 min ⁻¹	2,5 kW / 3400 min ⁻¹
Radna širina	890 mm	600 mm
Radna dubina	320 mm	230 mm
Broj noževa	6	6
Promjer noževa	360 mm	260 mm
Kapacitet spremnika goriva	3,6 l	1,2 l
Težina proizvoda	65,6 kg	35,0 kg
Bočni granični diskovi	•	•
Zakretni prednji kotač	•	•
Brzo paljenje	•	•
Zaustavljanje noževa otpuštanjem ručice	•	•
Ergonomske ručke	•	•
Ručke podesive po visini	•	•
Podesiva visina kočione noge	•	•
Brzina za vožnju unazad	•	-
Kotači (za upotrebu dodataka)	•	-
Broj artikla	34.315.10	34.302.81



4 006825 662443



4 006825 646351

BENZINSKA KOPAČICA



	GC-MT 2236 CLASSIC
Motor / obujam motora	4-taktni / 140 cm ³
Snaga / radna brzina	2,2 kW / 3200 min ⁻¹
Radna širina	360 mm
Radna dubina	220 mm
Broj noževa	4
Promjer noževa	260 mm
Kapacitet spremnika goriva	2,0 l
Težina proizvoda	28,8 kg
Bočni granični diskovi	-
Zakretni prednji kotač	•
Brzo paljenje	•
Zaustavljanje noževa otpuštanjem ručice	•
Ergonomske ručke	•
Ručke podesive po visini	•
Podesiva visina kočione noge	•
Brzina za vožnju unazad	-
Kotači (za upotrebu dodataka)	-
Broj artikla	34.315.01



4 006825 638066

PRIBOR ZA BENZINSKE KOPAČICE



	Plug ACCESSORY	Plug za krumpir ACCESSORY
Pogodno za	GC-MT 4280 (34.315.10)	GC-MT 4280 (34.315.10)
Broj artikla	34.315.20	34.315.30



4 006825 663419



4 006825 663426

ELEKTRIČNE KOPAČICE



	GC-RT 1545 M CLASSIC	GC-RT 7530 CLASSIC
Napon / snaga	230 - 240 V ~ 50 Hz / 1500 W	230 V ~ 50 Hz / 750 W
Radna širina	450 mm	300 mm
Radna dubina	220 mm	200 mm
Broj noževa	6	4
Promjer noževa	200 mm	220 mm
Težina proizvoda	10,4 kg	7,4 kg
Kopča za rasterećenje kabela	•	•
Zaštita od preopterećenja	•	-
Kotači podesivi po visini za jednostavni transport	•	-
Ergonomske ručke	•	•
Sklopiva ručka	•	•
Broj artikla	34.310.60	34.310.50



4 006825 652598



4 006825 602005

NJEGA DRVEĆA I GRMLJA



ELEKTRIČNE ŠKARE ZA ŽIVICU

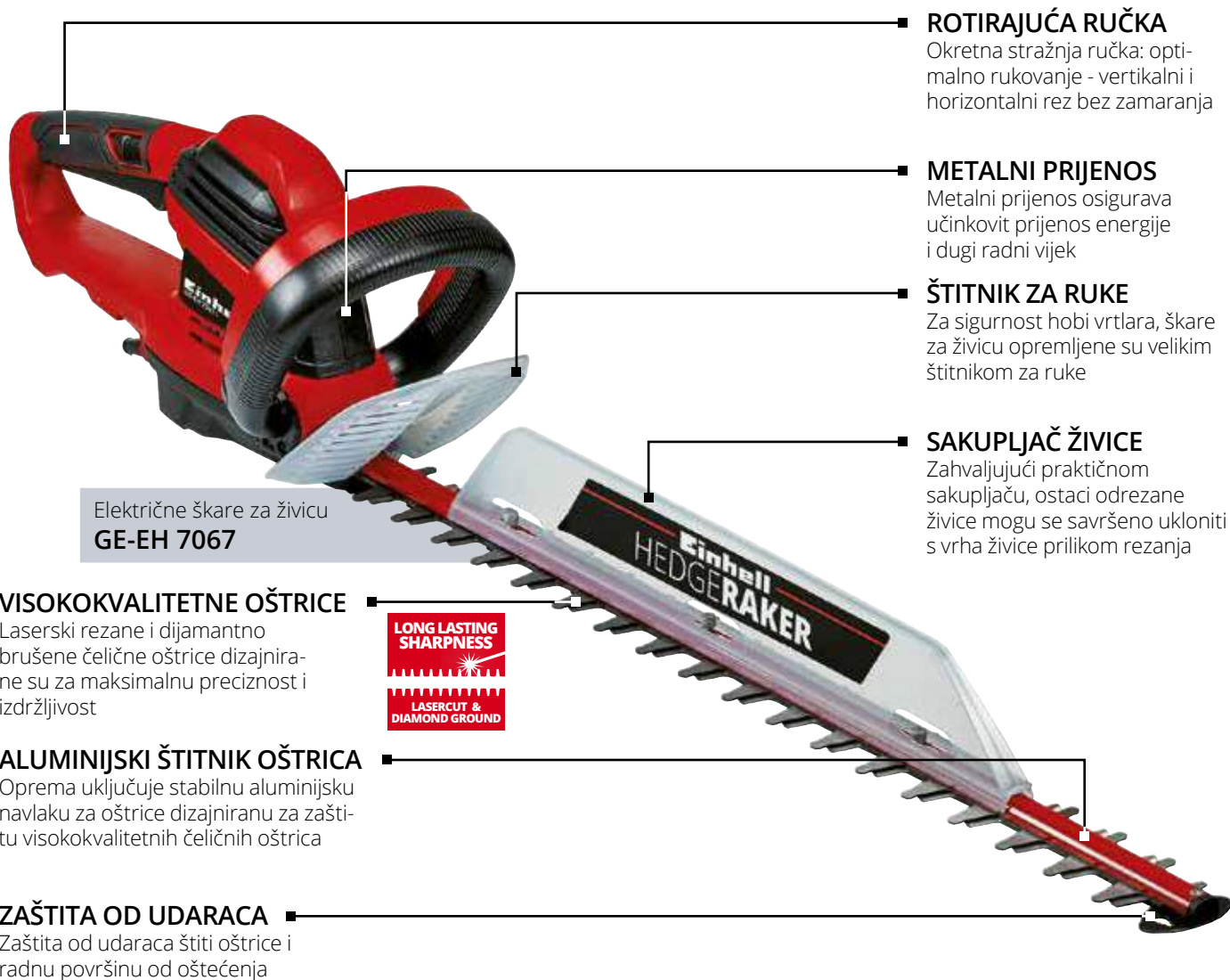

Električne škare za živicu
GE-EH 7067

ROTIRAJUĆA RUČKA

Okretna stražnja ručka: optimalno rukovanje - vertikalni i horizontalni rez bez zamaranja

METALNI PRIJENOS

Metalni prijenos osigurava učinkovit prijenos energije i dugi radni vijek

ŠTITNIK ZA RUKE

Za sigurnost hobi vrtlara, škare za živicu opremljene su velikim štitnikom za ruke

SAKUPLJAČ ŽIVICE

Zahvaljujući praktičnom sakupljaču, ostaci odrezane živice mogu se savršeno ukloniti s vrha živice prilikom rezanja

VISOKOKVALITETNE OŠTRICE

Laserski rezane i dijamantno brušene čelične oštrice dizajnirane su za maksimalnu preciznost i izdržljivost



ALUMINIJSKI ŠTITNIK OŠTRICA

Oprema uključuje stabilnu aluminijsku navlaku za oštrice dizajniranu za zaštitu visokokvalitetnih čeličnih oštrica

ZAŠTITA OD UDARACA

Zaštita od udaraca štiti oštrice i radnu površinu od oštećenja



ELEKTRIČNE ŠKARE ZA ŽIVICU

LONG LASTING
SHARPNESSTURNABLE
HANDLELASERCUT &
DIAMOND GROUND

	GE-EH 7067 EXPERT	GE-EH 6560 EXPERT
Napon / snaga	220 - 240 V ~ 50 Hz / 700 W	220 - 240 V ~ 50 Hz / 650 W
Duljina oštrice	710 mm	660 mm
Duljina reza	670 mm	600 mm
Razmak između zuba	30 mm	30 mm
Rezova u minuti	3000 min ⁻¹	3000 min ⁻¹
Težina proizvoda	3,7 kg	3,7 kg
Okretna stražnja ručka	•	•
Sakupljač živice	•	•
Laserski rezane i dijamantom brušene oštrice	•	•
Metalni prijenos	•	•
Mekani rukohvat	•	•
Aluminijski štitnik oštrica	•	•
Štitnik za ruke	•	•
Spojnica kabla	•	•
Zaštitni poklopac s nosačem za zid	•	•
Broj artikla	34.033.40	34.033.30



4 006825 616170



4 006825 616163

ELEKTRIČNE ŠKARE ZA ŽIVICU

LONG LASTING
SHARPNESSLONG LIFE
METAL GEARLASERCUT &
DIAMOND GROUND

	GC-EH 6055/1 CLASSIC
Napon / snaga	220 - 240 V ~ 50 Hz / 600 W
Duljina oštrice	610 mm
Duljina reza	550 mm
Razmak između zuba	26 mm
Rezova u minuti	2800 min ⁻¹
Težina proizvoda	3,5 kg
Okretna stražnja ručka	-
Sakupljač živice	•
Laserski rezane i dijamantom brušene oštrice	•
Metalni prijenos	•
Mekani rukohvat	•
Aluminijski štitnik oštrica	•
Štitnik za ruke	•
Spojnica kabla	•
Zaštitni poklopac s nosačem za zid	•
Broj artikla	34.033.20



4 006825 622157

ELEKTRIČNE ŠKARE ZA ŽIVICU



	GC-EH 4550 CLASSIC	GH-EH 4245 CLASSIC
Napon / snaga	230 V ~ 50 Hz / 450 W	230 V ~ 50 Hz / 420 W
Duljina oštrice	560 mm	510 mm
Duljina reza	500 mm	450 mm
Razmak između zuba	16 mm	16 mm
Rezova u minuti	3200 min ⁻¹	3200 min ⁻¹
Težina proizvoda	2,5 kg	2,5 kg
Okretna stražnja ručka	-	-
Sakupljač živice	-	-
Laserski rezane i dijamantom brušene oštrice	•	•
Metalni prijenos	•	•
Mekani rukohvat	•	•
Aluminijski štitičnik oštrica	•	•
Štitičnik za ruke	•	•
Spojnica kabla	•	•
Zaštitni poklopac s nosačem za zid	•	•
Broj artikla	34.033.70	34.034.60



4 006825 608236



4 006825 585049

BENZINSKE ŠKARE ZA ŽIVICU



	GE-PH 2555 A EXPERT
Snaga kW	0,85 kW
Zapremina motora	24,5 cm ³
Duljina oštrice	610 mm
Duljina reza	550 mm
Razmak između zuba	28 mm
Rezova u minuti	2050 min ⁻¹
Težina proizvoda	5,4 kg
Rotirajuća ručka	•
Ergonomska ručka	•
Antivibracijski sustav	•
Automatski čok - sustav za brzo pokretanje	•
Laserski rezane oštrice	•
Štitičnik za ruke	•
Sigurnosni prekidač	•
Zaštitni poklopac	•
Broj artikla	34.038.35



4 006825 585186

PRIBOR ŠKARE ZA ŽIVICU



	Sprej za njegu ACCESSORY
Pogodan za	Škare za živicu, škare za travu i grmlje
Broj artikla	34.030.99



4 006825 654608

AKUMULATORSKE ŠKARE ZA TRAVU I GRMLJE



	GE-CG 12 Li EXPERT	GE-CG 12 Li WT EXPERT
Baterija napon / kapacitet	12 V / 1,5 Ah	12 V / 1,5 Ah
Vrijeme punjenja	2 h	2 h
Radno vrijeme po punjenju baterije	100 min	100 min
Širina rezanja s oštricama za travu	100 mm	100 mm
Širina rezanja s oštricama za grmlje	190 mm	190 mm
Razmak između zuba oštrice za grmlje	8 mm	8 mm
Težina proizvoda	1,6 kg	0,8 kg
Zamjena lista pile bez upotrebe alata	•	•
Teleskopska drška	•	-
Veliki kotači	•	-
Laserski rezane oštrice	•	•
Metalni prijenos	•	•
Mekani rukohvat	•	•
Punjač	•	•
Broj artikla	34.104.01	34.104.11



4 006825 626216



4 006825 626223

AKUMULATORSKE ŠKARE ZA TRAVU I GRMLJE



	GC-CG 3,6/70 Li CLASSIC	GC-CG 3,6/70 Li WT CLASSIC
Baterija napon / kapacitet	3,6 V / 2,0 Ah	3,6 V / 2,0 Ah
Vrijeme punjenja	3-5 h	3-5 h
Radno vrijeme po punjenju baterije	60 min	60 min
Širina rezanja s oštricama za travu	70 mm	70 mm
Širina rezanja s oštricama za grmlje	110 mm	110 mm
Razmak između zuba oštrice za grmlje	8 mm	8 mm
Težina proizvoda	1,0 kg	0,6 kg
Zamjena oštrica bez upotrebe dodatnog alata	•	•
Teleskopska drška	•	-
Veliki kotači	•	-
Laserski rezane oštrice	-	-
Metalni prijenos	-	-
Mekani rukohvat	•	•
Broj artikla	34.103.60	34.103.65



4 006825 665161



4 006825 665444

ELEKTRIČNA TELESKOPSKA LANČANA PILA



	GC-EC 7520 T CLASSIC
Napon	220 - 240 V ~ 50 Hz
Snaga	750 W
Duljina oštrice	200 mm
Duljina reza	180 mm
Brzina reza	11 m/s
Maks. radna visina	3,0 m
Težina proizvoda	3,3 kg
Teleskopska drška	•
Zatezanje lanca bez upotrebe alata	•
Automatsko podmazivanje lanca	•
Veliki otvor za dolijevanje ulja	•
Zaštitni poklopac	•
Pojas za nošenje s brzim otpuštanjem	•
Broj artikla	45.012.40



4 006825 665277

ELEKTRIČNE TELESKOPSKE ŠKARE ZA ŽIVICU



	GC-HH 9046 CLASSIC	NOVO	GC-HH 5056 CLASSIC	NOVO
Napon	230 - 240 V ~ 50 Hz		230 - 240 V ~ 50 Hz	
Snaga	900 W		500 W	
Duljina oštrice	460 mm		560 mm	
Duljina reza	412 mm		470 mm	
Razmak između zuba	20 mm		20 mm	
Maks. radna visina	3,0 m		3,0 m	
Težina proizvoda	4,5 kg		4,0 kg	
Teleskopska drška	-		•	
Nagibna rezna glava	•		•	
Okretna stražnja ručka	•		-	
Laserski rezane i dijamantom brušene oštrice	•		•	
Metalni prijenos	•		•	
Zaštitni poklopac	•		•	
Pojas za nošenje s brzim otpuštanjem	•		•	
Broj artikla	34.038.80		34.038.70	



4 006825 666663



4 006825 666656

ELEKTRIČNI VIŠENAMJENSKI VRTNI ALAT

FITTED WITH
OREGON
 CHAIN AND BAR

LONG LASTING
 SHARPNESS
 LASERCUT &
 DIAMOND GROUND



	GC-HC 90/2046 T CLASSIC	NOVO
Napon	230 - 240 V ~ 50 Hz	
Snaga	900 W	
Motorna pila duljina mača	200 mm	
Motorna pila brzina reza	11 m/s	
Škare za živicu duljina reza	412 mm	
Škare za živicu razmak između zuba	20 mm	
Maks. radna visina	3,0 m (lančana pila) / 3,0 m (škare za živicu)	
Težina proizvoda	6,9 kg (uklj. sve dodatke)	
Teleskopska drška	-	
Nagibna rezna glava	•	
Okretna stražnja ručka	•	
OREGON kvalitetni mač i lanac	•	
Automatsko podmazivanje lanca	•	
Laserski rezane i dijamentom brušene oštrice	•	
Zaštitni poklopac	•	
Pojas za nošenje s brzim otpuštanjem	•	
Broj artikla	45.012.90	



ELEKTRIČNE LANČANE PILE

ZAŠTITA OD POVRATNOG UDARCA

Optimalna sigurnost zahvaljujući velikom štitniku za ruke s trenutnom kočnicom lanca

ERGONOMSKA POZICIJA RUČKE

Za dobro i sigurno vođenje u svim radnim situacijama - za okomite i vodoravne rezove pridonosi i ergonomsko poravnanje ručki

Električna lančana pila
GC-EC 2040

MEKANI RUKOHVAT

Bolje držanje, sigurno vođenje i ergonomski rad

OTVOR ZA PUNJENJE ULJA

Veliki otvor za punjenje olakšava dolijevanje ulja za lanac

METALNI GRANIČNIK

Robusni metalni graničnik podržava sigurno i precizno vođenje pile

OREGON KVALITETNI MAČ I LANAC

FITTED WITH

OREGON
CHAIN AND BAR

ZATEZANJE I IZMJENA LANCA BEZ ALATA

Jednostavno za korištenje: zatezanje i izmjena lanca motorne pile bez potrebe za dodatnim alatima

METALNI PRIJENOS

Metalni prijenos osigurava učinkovit prijenos energije i dugi radni vijek



ELEKTRIČNA LANČANA PILA



FITTED WITH
OREGON
CHAIN AND BAR



	GE-EC 2240 EXPERT
Napon	220 - 240 V ~ 50/60 Hz
Snaga	2200 W
Duljina oštrice	406 mm
Duljina reza	375 mm
Brzina reza	15 m/s
Kapacitet spremnika za ulje	150 ml
Težina proizvoda	5,6 kg
Metalni prijenos	•
OREGON kvalitetni mač i lanac	•
Zatezanje i zamjena lanca bez upotrebe alata	•
Automatsko podmazivanje lanca	•
Robusni metalni graničnik	•
Zaštita od povratnog udarca + trenutna kočnica lanca	•
Osigurač lanca	•
Mekani rukohvat	•
Polagano pokretanje	•
Zaštitni poklopac	•
Broj artikla	45.017.40



ELEKTRIČNE LANČANE PILE



FITTED WITH
OREGON
CHAIN AND BAR

FITTED WITH
OREGON
CHAIN AND BAR



	GC-EC 2040 CLASSIC	GC-EC 1935 CLASSIC	GH-EC 1835 CLASSIC
Napon	230 - 240 V ~ 50 Hz	230 - 240 V ~ 50 Hz	230 - 240 V ~ 50 Hz
Snaga	2000 W	1900 W	1800 W
Duljina oštrice	400 mm	350 mm	350 mm
Duljina reza	375 mm	325 mm	325 mm
Brzina reza	15,5 m/s	15,5 m/s	13,5 m/s
Kapacitet spremnika za ulje	160 ml	160 ml	160 ml
Težina proizvoda	5,0 kg	4,7 kg	5,4 kg
Metalni prijenos	•	•	•
OREGON kvalitetni mač i lanac	•	•	-
Zatezanje i zamjena lanca bez upotrebe alata	•	•	•
Automatsko podmazivanje lanca	•	•	•
Robusni metalni graničnik	•	•	•
Zaštita od povratnog udarca + trenutna kočnica lanca	•	•	•
Osigurač lanca	•	•	•
Mekani rukohvat	•	•	•
Polagano pokretanje	-	-	-
Zaštitni poklopac	•	•	•
Broj artikla	45.012.30	45.012.20	45.017.10



MOTORNE PILE



	GC-PC 2040 I CLASSIC	GC-PC 1435 I TC CLASSIC
Snaga kW / KS	2,0 kW / 2,7 KS	1,4 kW / 1,9 KS
Zapremina motora	50,4 cm ³	41 cm ³
Duljina oštrice	400 mm	350 mm
Duljina reza	390 mm	335 mm
Brzina reza	21 m/s	21 m/s
Kapacitet spremnika goriva	540 ml	260 ml
Kapacitet spremnika za ulje	240 ml	210 ml
Težina proizvoda	6,5 kg	5,5 kg
OREGON kvalitetni mač i lanac	•	•
Digitalno paljenje – stabilan rad motora	•	•
Automatski čok – brzo paljenje	•	•
Zatezanje i zamjena lanca bez upotrebe alata	–	•
Automatsko podmazivanje lanca	•	•
Robusni metalni graničnik	•	•
Zaštita od povratnog udarca + trenutna kočnica lanca	•	•
Zaštitni poklopac	•	•
Posuda za miješanje benzina/ulja	•	•
Broj artikla	45.018.51	45.018.29



4 006825 613278



4 006825 641714

MOTORNA PILA



	GC-PC 1335/1 I CLASSIC
Snaga kW / KS	1,3 kW / 1,7 KS
Zapremina motora	37,2 cm ³
Duljina oštrice	350 mm
Duljina reza	345 mm
Brzina reza	21,9 m/s
Kapacitet spremnika goriva	300 ml
Kapacitet spremnika za ulje	170 ml
Težina proizvoda	5,3 kg
OREGON kvalitetni mač i lanac	•
Digitalno paljenje – stabilan rad motora	•
Automatski čok – brzo paljenje	•
Zatezanje i zamjena lanca bez upotrebe alata	–
Automatsko podmazivanje lanca	•
Robusni metalni graničnik	•
Zaštita od povratnog udarca + trenutna kočnica lanca	•
Zaštitni poklopac	•
Posuda za miješanje benzina/ulja	•
Broj artikla	45.018.70



4 006825 641738

ELEKTRIČNI OŠTRAČ LANACA



	GC-CS 235 E CLASSIC	GC-CS 85 E CLASSIC
Napon	230 V ~ 50 Hz	220 - 240 V ~ 50 Hz
Snaga	235 W	85 W
Promjer brusne ploče (unutarnji)	22 mm	23 mm
Promjer brusne ploče (vanjski)	145 mm	108 mm
Debljina brusne ploče	3,2 mm	3,2 mm
Težina proizvoda	5,8 kg	1,9 kg
Graničnik dubine	•	•
Skala za precizno podešavanje kuta oštrenja	•	•
Uređaj za zatezanje	•	•
Zakretna glava za podešavanje krovnog kuta	•	-
Osvjetljenje	•	-
Providno staklo za pregled	•	-
Broj artikla	44.999.10	44.999.20



4 006825 613148



4 006825 613834

PRIBOR ZA OBRADU DRVETA



	Zaštitna šumarska kaciga	Kombinirani spremnik
Težina proizvoda	0,7 kg	0,9 kg
Broj artikla	45.004.80	45.013.25



4 006825 544565



4 006825 542851



	Stalak za piljenje drva
Težina proizvoda	7,1 kg
Broj artikla	45.000.67



4 006825 548693

ELEKTRIČNI USISAVAČI/ PUHAČI LIŠĆA

2IN1

• SAUGEN
• BLASEN



AIR SPEED
MIN - MAX



	GC-EL 3000 E CLASSIC	GC-EL 3024 E CLASSIC
Napon	220 - 240 V ~ 50 Hz	230 - 240 V ~ 50 Hz
Snaga	3000 W	3000 W
Maks. protok puhanja zraka	300 km/h	240 km/h
Maks. usisna snaga	840 m ³ /h	650 m ³ /h
Broj okretaja	8000 - 15000 min ⁻¹	7000 - 13500 min ⁻¹
Funkcija sjeckanja	15:1	10:1
Kapacitet vreće za lišće	45 l	40 l
Težina proizvoda	3,0 kg (puhač) / 4,2 kg (usisavač)	3,1 kg
Izmjena funkcije usisavanje / puhanje bez upotrebe alata	•	•
Elektronska kontrola brzine	•	•
Dodatna drška	• (podesiva)	•
Aluminijski rotor za puhanje	•	-
Kotači za vođenje	• (podesivo po visini)	•
Vreća za lišće s prozorom	•	•
Pojas za nošenje	•	•
Mekani rukohvat	•	-
Broj artikla	34.333.20	34.333.70



2u1

USISAVAČ | PUHAČ

* Opseg isporuke GC-EL 3000 E uključuje široku, veliku usisnu cijev i dodatnu, laganu, usku cijev za puhanje. To olakšava rukovanje uređajem kako u funkciji usisavanja tako i u funkciji puhanja. Izmjena funkcija moguća je bez upotrebe dodatnog alata.

SJECKALICE GRANA



	GC-KS 2540 CB CLASSIC	GC-KS 2540 CLASSIC
Napon	220 - 240 V ~ 50 Hz	220 - 240 V ~ 50 Hz
Snaga	2500 W (P40) / 2000 W	2500 W (P40) / 2000 W
Broj okretaja	3800 min ⁻¹	3800 min ⁻¹
Maks. promjer grane	40 mm	40 mm
Kapacitet kante za vrtni otpad	55 l	-
Težina proizvoda	13,0 kg	10,0 kg
Transportni kotači	•	•
Transportna ručka	•	•
Veliki otvor za umetanje grana	•	•
Odčeppljivač	•	•
Kanta za vrtni otpad	•	-
Vreća za vrtni otpad	-	•
Broj artikla	34.304.00	34.303.30



4 006825 652765



4 006825 638233

DROBILICE GRANA



	GC-RS 60 CB CLASSIC	GC-RS 2540 CLASSIC
Napon	230 - 240 V ~ 50 Hz	230 V ~ 50 Hz
Snaga	2800 W (P40) / 2300 W	2500 W (P40) / 2000 W
Broj okretaja	40 min ⁻¹	40 min ⁻¹
Maks. promjer grane	45 mm	40 mm
Kapacitet kante za vrtni otpad	60 l	-
Težina proizvoda	29,5 kg	24,9 kg
Transportni kotači	•	•
Transportna ručka	•	•
Prekidač obrnutog smjera	•	•
Veliki otvor za umetanje grana	•	•
Odčeppljivač	-	-
Kanta za vrtni otpad	•	-
Vreća za vrtni otpad	-	•
Broj artikla	34.306.35	34.306.20



4 006825 645880



4 006825 608403

NAVODNJAVANJE





NAVODNJAVANJE

KRATKI PREGLED PREDNOSTI



ODVODNJA

- Brza isporuka velike količine vode
- Prevencija velikih šteta pomoću brzog ispumpavanja vode
- Visoka pouzdanost u radu



ZALIJEVANJE

- Ravnomjerno navodnjavanje vrta
- Praktično i sigurno rukovanje
- Čuva resurse i šteti pitku vodu



KUĆNI VODOVODNI SISTEMI

- Opskrba vrta i domaćinstva iz alternativnih rezervoara vode (cisterne, bunari)
- Praktično i sigurno rukovanje
- Čuva resurse i šteti pitku vodu

■ ODVODNJA

Pretakanje ili ispumpavanje vode sada je brže i lakše nego ikad. S Einhell pumpama nema problema kod ispumpavanja čiste ili prljave vode s visokom brzinom isporuke.

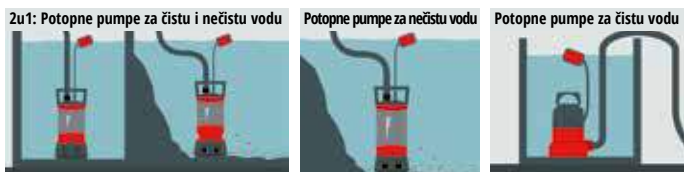

PROIZVODI

- 2u1 kombinirane potopne pumpe (čista i nečista voda)
- Potopne pumpe za nečistu vodu
- Potopne pumpe za čistu vodu
- Potopne pumpe s AQUA senzorom

PODRUČJA PRIMJENE

- Ispumpavanje poplavljenih podruma, garaža ili praonica
- Ispumpavanje i pretakanje iz bazena, vrtnih jezeraca, građevinskih jama i odvodnih kanala



■ ZALIJEVANJE

Kako bi se izbjeglo trošenje dragocjene pitke vode na zalijevanje vrta, preporučljivo je koristiti alternativne izvore vode kao što su kišnica ili voda iz cisterni

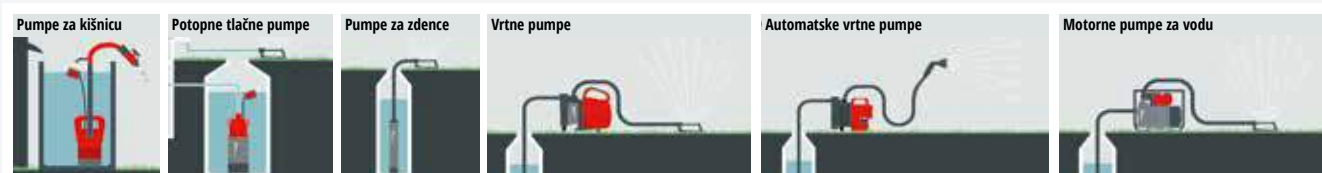

PROIZVODI

- Pumpe za kišnicu
- Potopne tlačne pumpe
- Pumpe za zdence
- Vrtne pumpe
- Automatske vrtne pumpe
- Motorne pumpe za vodu

PODRUČJA PRIMJENE

- Rukovanje prskalicama za travu i vrtnim tuševima
- Ispumpavanje vode iz bunara ili cisterni
- Korištenje kišnice iz različitih spremnika za zalijevanje vrta



■ KUĆNI VODOVODNI SISTEMI

Zahvaljujući širokom rasponu primjena, kuća ili vrt mogu se automatski opskrbiti vodom koja nije za piće.

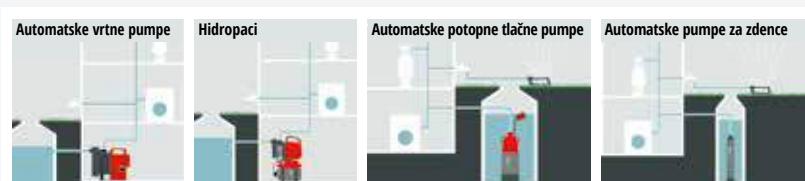

PROIZVODI

- Automatske vrtne pumpe
- Hidropaci
- Automatske potopne tlačne pumpe
- Automatske pumpe za zdence

PODRUČJA PRIMJENE

- Voda iz alternativnih izvora za opskrbu doma (stroj za pranje rublja, sistem za ispiranje WC-a)
- Povećanje tlaka u kućnim vodovodnim sistemima



POTOPNA PUMPA ZA ČISTU VODU S AQUA SENZOROM

ZAŠTITA 24 SATA DNEVNO



RUČKA ZA NOŠENJE

Čvrsta ergonomska ručka za nošenje s integriranim rupom za uže za brzi početak rada

KUČIŠTE PUMPE

Izdržljivo kućište pumpe izrađeno od plastike otporne na udarce s vanjskom oblogom od nehrđajućeg čelika pouzdano podnosi najviše zahtjeve

DUGAČKI STRUJNI KABEL

Dugački priključni kabel (10 m) omogućuje korištenje čak i na vrlo velikim dubinama uranjanja



PRIKLJUČAK CRIJEVA

Univerzalni priključak dostupan na vrhu pumpe

PATENTIRANO PODEŠAVANJE SENZORA

Postavka tri početne visine senzora ili funkcija kontinuiranog rada



INTEGRIRANI AQUA SENZOR

Zbog integriranog aqua senzora, pumpa ima tanak dizajn, što joj omogućuje upotrebu u skućenim prostorima, npr. u kanalima



Potopna pumpa za čistu vodu s AQUA senzorom
GE-SP 4390 N-ALL ECO

POTOPNA PUMPA ZA ČISTU VODU S AQUA SENZOROM



	GE-SP 4390 N-ALL ECO EXPERT
Napon	230 V ~ 50 Hz
Snaga	430 W
Maks. dostavni kapacitet / maks. dostavna visina	9000 l/h / 8 m
Maks. dubina uranjanja	7 m
Maks. veličina stranih čestica	1 mm
Pokretanje pumpe u kontinuiranom modu	5 mm
Pokretanje pumpe sa senzorom 1	5 mm
Pokretanje pumpe sa senzorom 2	56 mm
Pokretanje pumpe sa senzorom 3	103 mm
Ispumpavanje čiste vode do razine	1 mm
Priključak crijeva	47,8 mm (1½") VN
Strujni kabel	10 m
Težina proizvoda	4,9 kg
Aqua Sensor tehnologija	•
Kontinuirani rad bez senzora	•
Nepovratni ventil	•
Visokokvalitetno mehaničko brtvljenje	•
Integrirani nosač za namatanje kabela	-
Ručka za nošenje	•
Integrirana rupa za uže	•
ECO Power	•
Adapter za univerzalno crijevo	•
Broj artikla	41.714.40



POTOPNE PUMPE ZA NEČISTU VODU S AQUA SENZOROM



	GE-DP 7935 N-A ECO EXPERT	GE-DP 6935 A ECO EXPERT
Napon	230 V ~ 50 Hz	230 V ~ 50 Hz
Snaga	790 W	690 W
Maks. dostavni kapacitet / maks. dostavna visina	19000 l/h / 9 m	17500 l/h / 9 m
Maks. dubina uranjanja	7 m	7 m
Maks. veličina stranih čestica	35 mm	35 mm
Pokretanje pumpe u kontinuiranom modu	50 mm	50 mm
Pokretanje pumpe sa senzorom 1	70 mm	70 mm
Pokretanje pumpe sa senzorom 2	135 mm	135 mm
Pokretanje pumpe sa senzorom 3	188 mm	188 mm
Ispumpavanje čiste vode do razine	40 mm	40 mm
Priključak crijeva	47,8 mm (1½") VN	47,8 mm (1½") VN
Strujni kabel	10 m	10 m
Težina proizvoda	6,2 kg	5,7 kg
Aqua Sensor tehnologija	•	•
Kontinuirani rad bez senzora	•	•
Nepovratni ventil	•	•
Visokokvalitetno mehaničko brtvljenje	•	•
Integrirani nosač za namatanje kabela	•	•
Ručka za nošenje	•	•
Integrirana rupa za užu	•	•
ECO Power	•	•
Adapter za univerzalno crijevo	•	•
Broj artikla	41.714.60	41.714.50



PATENTIRANA AQUA SENZOR TEHNOLOGIJA

Jednostavno podešavanje tri početne visine rada sa senzorom ili funkcija kontinuiranog rada.

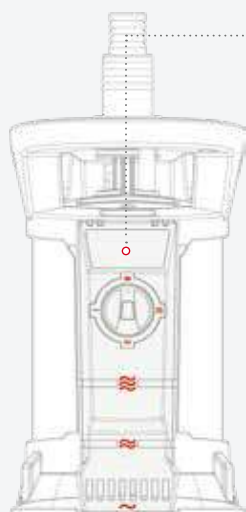
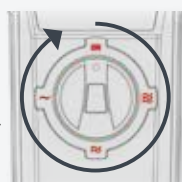

	AQUA SENSOR DIRTY WATER	AQUA SENSOR CLEAR WATER
Kontinuirani rad (ON/OFF) bez početka rada pomoću senzora		
•	50 mm	5 mm
Automatski start sa senzorom		
•	188 mm	103 mm
Automatski start sa senzorom		
•	135 mm	56 mm
Automatski start sa senzorom		
•	70 mm	5 mm

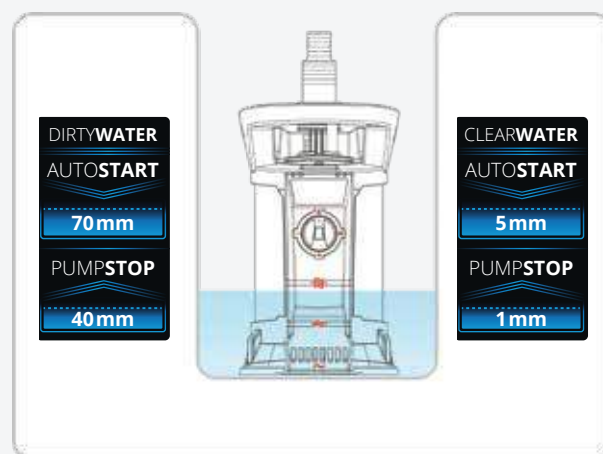

POTOPNE PUMPE ZA ČISTU I NEČISTU VODU

PLUTAJUĆI PREKIDAČ

Beskonačno podesiv, koristi se za automatsku kontrolu razine vode

PRIKLJUČAK CRIJEVA

Univerzalni priključak lako dostupan na vrhu pumpe

2u1 FUNKCIJA

Ispumpavanje čiste i nečiste vode jednim uređajem

2u1 kombinirana potopna pumpa
GE-DP 7330 LL ECO



RUČKA ZA NOŠENJE

Stabilna i ergonomska ručka za nošenje s integriranom rupom za uže

KUĆIŠTE PUMPE

Izdržljivo kućište pumpe izrađeno od plastike otporne na udarce s vanjskom oblogom od nehrđajućeg čelika pouzdano podnosi najviše zahtjeve

PATENTIRANA REGULACIJA RAZINE USISAVANJA

S patentiranom kontrolom razine usisavanja, brza prilagodba željene funkcije (rad s čistom vodom ili rad s nečistom vodom) može se izvršiti jednostavnim okretanjem podnožja pumpe



POTOPNE PUMPE ZA ČISTU I NEČISTU VODU



	GE-DP 7330 LL ECO EXPERT	GE-DP 5220 LL ECO EXPERT	GC-DP 7035 LL CLASSIC
Napon	230 V ~ 50 Hz	230 V ~ 50 Hz	230 V ~ 50 Hz
Snaga	730 W	520 W	700 W
Maks. dostavni kapacitet / maks. dostavna visina	16500 l/h / 8,5 m	13500 l/h / 7,5 m	16000 l/h / 8 m
Maks. dubina uranjanja	7 m	7 m	7 m
Maks. veličina stranih čestica	30 mm	20 mm	35 mm
Ispumpavanje čiste vode do razine	1 mm	1 mm	1 mm
Pokretanje pumpe od razine vode	10 mm	10 mm	10 mm
Priključak crijeva	47,8 mm (1½") VN	47,8 mm (1½") VN	47,8 mm (1½") VN
Strujni kabel	10 m	10 m	10 m
Težina proizvoda	6,2 kg	5,4 kg	4,45 kg
Patentirana regulacija razine usisavanja	•	•	•
Visokokvalitetno mehaničko brtvljenje	•	•	•
Plutajući prekidač	Automatski i ručni način rada	Automatski i ručni način rada	Automatski i ručni način rada
Integrirani nosač za namatanje kabela	•	•	•
ECO Power	•	•	-
Ručka za nošenje s integriranom rupom za užu	•	•	•
Adapter za univerzalno crijevo	•	•	•
Broj artikla	41.707.90	41.707.80	41.815.70



4 006825 598827



4 006825 598780



4 006825 662085

POTOPNE PUMPE ZA ČISTU I NEČISTU VODU

- 1 Kada je aktivirana funkcija za čistu vodu: pumpa se pokreće od 10 mm razine vode - to nudi samo nekoliko pumpi na tržištu - i usisava čistu vodu sve do razine od 1 mm, tj. kratko brisanje krpom i poplava je brzo zaboravljena.
- 2 Kada je aktivirana funkcija za nečistu vodu: usisavanje bez poteškoća čak i velikih stranih čestica poput kamenja i gruda mulja promjera do 20/30/35 mm (ovisno o modelu).
- 3 2u1 funkcija: ispušavanje čiste i nečiste vode sa samo jednim uređajem!
- 4 Patentirana regulacija razine usisavanja: jednostavnim okretanjem podnožja pumpe prebacuje se funkcija za plitko usisavanje čiste vode ili za usisavanje nečiste vode s velikim stranim česticama.



POTOPNE PUMPE ZA ČISTU I NEČISTU VODU ECO



	GE-DP 7935 N ECO EXPERT	GE-DP 3925 ECO EXPERT
Pogodna za	Nečistu vodu	Nečistu vodu
Napon	230 V ~ 50 Hz	230 V ~ 50 Hz
Snaga	790 W	390 W
Maks. dostavni kapacitet / maks. dostavna visina	20000 l/h / 9 m	10000 l/h / 6 m
Maks. dubina uranjanja	7 m	7 m
Min. razina vode za pokretanje pumpe	50 mm	50 mm
Maks. veličina stranih čestica	35 mm	25 mm
Priključak crijeva	47,8 mm (1½") VN	47,8 mm (1½") VN
Strujni kabel	10 m	10 m
Težina proizvoda	7,3 kg	4,5 kg
Integrirana rupa za uže	•	•
Visokokvalitetno mehaničko brtvljenje	•	•
Plutajući prekidač	Automatski i ručni način rada	Automatski i ručni način rada
Integrirani nosač za namatanje kabela	•	•
ECO Power	•	•
Ručka za nošenje	•	•
Nepovratni ventil	-	-
Adapter za univerzalno crijevo	•	•
Broj artikla	41.707.00	41.707.10



4 006825 572322



4 006825 572339

POTOPNE PUMPE ZA NEČISTU VODU



	GC-DP 1340 G CLASSIC	GE-DP 900 Cut EXPERT	GC-DP 5010 G CLASSIC
Napon	230 V ~ 50 Hz	230 V ~ 50 Hz	220 - 240 V ~ 50 Hz
Snaga	1300 W	900 W	500 W
Maks. dostavni kapacitet / maks. dostavna visina	23000 l/h / 10 m	16000 l/h / 11,5 m	12000 l/h / 8 m
Maks. dubina uranjanja	5 m	7 m	5 m
Maks. veličina stranih čestica	40 mm	-	10 mm
Priključak crijeva	59,6 mm (2") UN	59,6 mm (2") UN	42 mm (1¼") UN
Strujni kabel	10 m	10 m	10 m
Težina proizvoda	22,0 kg	17,0 kg	10,6 kg
Visokokvalitetno mehaničko brtvljenje	•	•	•
Plutajući prekidač	Automatski način rada	Automatski način rada	Automatski način rada
Integrirani nosač za namatanje kabela	-	-	-
Ručka za nošenje	•	•	•
Sustav rezanja čestica prljavštine	-	•	-
Adapter za univerzalno crijevo	•	•	•
Uže za spuštanje	• (6 m)	-	-
Broj artikla	41.707.42	41.815.50	41.714.21



4 006825 597882



4 006825 660852



4 006825 626193

POTOPNE PUMPE ZA NEČISTU VODU



	GC-DP 9040 N CLASSIC	GC-DP 9035 N CLASSIC	GC-DP 7835 CLASSIC
Napon	230 V ~ 50 Hz	220 - 240 V ~ 50 Hz	230 V ~ 50 Hz
Snaga	900 W	900 W	780 W
Maks. dostavni kapacitet / maks. dostavna visina	22000 l/h / 9 m	18000 l/h / 9 m	15700 l/h / 8 m
Maks. dubina uranjanja	7 m	5 m	7 m
Maks. veličina stranih čestica	40 mm	35 mm	35 mm
Priključak crijeva	50 mm (2") UN	47,8 mm (1½") UN	47,8 mm (1½") UN
Strujni kabel	10 m	10 m	10 m
Težina proizvoda	7,5 kg	6,0 kg	5,2 kg
Visokokvalitetno mehaničko brtvljenje	•	•	•
Plutajući prekidač	Automatski i ručni način rada	Automatski i ručni način rada	Automatski i ručni način rada
Integrirani nosač za namatanje kabela	•	-	•
Ručka za nošenje	•	•	•
Sustav rezanja čestica prljavštine	-	-	-
Adapter za univerzalno crijevo	•	•	•
Uže za spuštanje	-	-	-
Broj artikla	41.815.10	41.707.78	41.706.82



POTOPNE PUMPE ZA NEČISTU VODU



	GC-DP 6315 N CLASSIC	GC-DP 3325 CLASSIC
Napon	230 V ~ 50 Hz	230 V ~ 50 Hz
Snaga	630 W	330 W
Maks. dostavni kapacitet / maks. dostavna visina	17000 l/h / 8 m	9500 l/h / 6 m
Maks. dubina uranjanja	5 m	5 m
Maks. veličina stranih čestica	15 mm	25 mm
Priključak crijeva	47,8 mm (1½") UN	47,8 mm (1½") UN
Strujni kabel	10 m	10 m
Težina proizvoda	4,7 kg	3,6 kg
Visokokvalitetno mehaničko brtvljenje	•	•
Plutajući prekidač	Automatski i ručni način rada	Automatski i ručni način rada
Integrirani nosač za namatanje kabela	•	-
Ručka za nošenje	•	• (sklopiva)
Sustav rezanja čestica prljavštine	-	-
Adapter za univerzalno crijevo	•	•
Uže za spuštanje	-	-
Broj artikla	41.704.91	41.815.30



POTOPNE PUMPE ZA ČISTU VODU

RUČKA ZA NOŠENJE

Praktičan transport pomoću stabilne, ergonomске ručke za nošenje

Potopna pumpa za čistu vodu
GC-SP 3580 LL



PLUTAJUĆI PREKIDAČ

Pumpa se automatski uključuje i isključuje na unaprijed odabranoj razini vode preko kontinuirano podesivog plutajućeg prekidača

UNIVERZALNI PRIKLJUČAK CRIJEVA

Priključak za crijeva od 25 / 38 mm i vanjski navoj od 33,3 mm (1")

NAMATANJE KABELA

Praktično spremište za strujni kabel za uredno skladištenje

NISKA RAZINA USISAVANJA VODE

Pumpa se može koristiti na razini vode od samo 8 mm i usisava vodu sve do razine od 1 mm - na završetku izvlačenja vode dovoljno je pod obrisati krpom

POTOPNA PUMPA ZA ČISTU VODU



	GC-SP 5511 IF CLASSIC
Napon	230 V ~ 50 Hz
Snaga	550 W
Maks. dostavni kapacitet / maks. dostavna visina	11000 l/h / 8,5 m
Maks. dubina uranjanja	7 m
Priključak crijeva	47,8 mm (1½") UN
Strujni kabel	10 m
Min. razina vode za pokretanje pumpe	60 mm
Ispumpavanje čiste vode do razine	5 mm
Težina proizvoda	4,4 kg
Visokokvalitetno mehaničko brtvljenje	-
Plutajući prekidač	Integrirano (automatski + ručni način rada)
Integrirani nosač za namatanje kabela	-
Ručka za nošenje	•
Adapter za univerzalno crijevo	•
Broj artikla	41.704.63



POTOPNE PUMPE ZA ČISTU VODU



	GC-SP 3580 LL CLASSIC	GC-SP 2275 CLASSIC
Napon	230 V ~ 50 Hz	230 V ~ 50 Hz
Snaga	350 W	220 W
Maks. dostavni kapacitet / maks. dostavna visina	8000 l/h / 7,5 m	7500 l/h / 6 m
Maks. dubina uranjanja	7 m	5 m
Priključak crijeva	47,8 mm (1½") UN	47,8 mm (1½") UN
Strujni kabel	10 m	10 m
Min. razina vode za pokretanje pumpe	8 mm	-
Ispumpavanje čiste vode do razine	1 mm	8 mm
Težina proizvoda	3,1 kg	3,4 kg
Visokokvalitetno mehaničko brtvljenje	•	•
Plutajući prekidač	Automatski i ručni način rada	Automatski i ručni način rada
Integrirani nosač za namatanje kabela	•	-
Ručka za nošenje	•	• (sklopiva)
Adapter za univerzalno crijevo	•	•
Broj artikla	41.704.45	41.815.20



4 006825 615197



4 006825 655070

POTOPNA PUMPA ZA KIŠNICU



	GE-SP 3546 RB EXPERT
Napon	230 V ~ 50 Hz
Snaga	350 W
Maks. dostavni kapacitet / maks. dostavna visina	4600 l/h / 11 m
Maks. dubina uranjanja	7 m
Maks. veličina stranih čestica	2,5 mm
Priključak crijeva	26,4 mm (¾") VN
Strujni kabel	10 m
Ispumpavanje čiste vode do razine	-
Težina proizvoda	5,0 kg
Visokokvalitetno mehaničko brtvljenje	-
Plutajući prekidač	• (beskonačno podesiv)
Integrirani nosač za namatanje kabela	•
Ručka za nošenje	•
Fleksibilan vrat produžne cijevi	•
Pretinac za pohranjivanje produžne cijevi	•
Adapter za univerzalno crijevo	-
Broj artikla	41.704.38



4 006825 623598

**POTOPNE PUMPE ZA ČISTU, NEČISTU VODU I KIŠNICU
TAKOĐER SU DOSTUPNE U
AKUMULATORSKOJ IZVEDBI.
VIŠE NA 56. STRANICI**

POTOPNE TLAČNE PUMPE



PRIKLJUČAK CRIJEVA S INOX UMETKOM

Priključak crijeva s umetkom od nehrđajućeg čelika posebno je robustan i izdržljiv. Dostupan je s gornje strane pumpe i omogućuje korištenje u vrlo uskim prostorima

KUĆIŠTE PUMPE

Izdržljivo kućište pumpe izrađeno od nehrđajućeg čelika pouzdano podnosi najviše zahtjeve

AUTOMATSKA FUNKCIJA

Kada postoji potreba za vodom, uređaj se automatski uključuje i zatim ponovno isključuje

4-STUPANJSKI SUSTAV ROTORA

Sustav rotora ima 4-stupanjsku strukturu i na taj način osigurava izrazito visok tlak isporuke

VISOKOKVALITETNA MEHANIČKA BRTVA

Visokokvalitetno mehaničko brtvljenje smanjuje trenje i trošenje i time jamči dugotrajnu upotrebu

Potopna tlačna pumpa
GE-PP 1100 N-A

POTOPNE TLAČNE PUMPE



2in1
TAUCHDRUCK-
PUMPE
+
REGENFAS-
PUMPE

	GE-PP 1100 N-A EXPERT	GC-PP 900 N CLASSIC	GE-PP 5555 RB-A EXPERT
Napon	220 - 240 V ~ 50 Hz	230 V ~ 50 Hz	230 - 240 V ~ 50 Hz
Snaga	1100 W	900 W	550 W
Maks. dostavni kapacitet / maks. dostavna visina	6000 l/h / 45 m	6000 l/h / 32 m	5500 l/h / 20 m
Maks. dubina uranjanja	12 m	7 m	7 m
Priključak crijeva	33,3 mm (1") UN	33,3 mm (1") UN	33,3 mm (1") VN
Strujni kabel	15 m	10 m	10 m
Težina proizvoda	8,7 kg	8,9 kg	5,0 kg
Automatska funkcija	•	-	•
Plutajući prekidač	-	•	-
Zaštita od rada na suho	•	-	•
Višestupanjski rotor pumpe	• (4 kom)	• (3 kom)	• (2 kom)
Visokokvalitetno mehaničko brtvljenje	•	•	•
Zaštita od preopterećenja	•	•	•
Integrirani nepovratni ventil	•	-	•
Sito za prljavštinu na dnu pumpe	•	-	-
Kućište od nehrđajućeg čelika	•	•	-
Integrirani nosač za namatanje kabela	-	-	•
Ručka za nošenje	•	-	•
Teleskopska produžna cijev	-	-	•
Fleksibilan vrat produžne cijevi	-	-	•
Broj artikla	41.714.30	41.709.64	41.704.25



PUMPE ZA ZDENCE



	GE-DW 1155 N-A EXPERT	GC-DW 1300 N CLASSIC	GC-DW 1045 N CLASSIC
Napon	220 - 240 V ~ 50 Hz	230 V ~ 50 Hz	220 - 240 V ~ 50 Hz
Snaga	1100 W	1300 W	1000 W
Maks. dostavni kapacitet / maks. dostavna visina	6000 l/h / 55 m	5000 l/h / 65 m	6500 l/h / 45 m
Maks. dubina uranjanja	19 m	20 m	19 m
Priključak crijeva	33,3 mm (1") UN	47,8 mm (1½") UN	42 mm (1¼") UN
Strujni kabel	22 m	2 m / 23 m	22 m
Promjer pumpe	98 mm	102 mm	98 mm
Težina proizvoda	9,8 kg	15,5 kg	7,7 kg
Automatska funkcija	•	-	-
Zaštita od rada na suho	•	-	-
Višestupanjski rotor pumpe	• (8 kom)	• (10 kom)	• (6 kom)
Visokokvalitetno mehaničko brtvljenje	•	•	•
Zaštita od preopterećenja	•	•	•
Integrirani nepovratni ventil	•	•	•
Sito za prijavštinu na dnu pumpe	•	•	•
Kućište od nehrđajućeg čelika	•	•	•
Vanjska kontrolna jedinica	-	•	-
Uže za spuštanje	• (22 m)	• (20 m)	• (22 m)
Broj artikla	41.709.37	41.709.44	41.709.55



POVRŠINSKE PUMPE PLUS

JEDNOSTAVNO ISPUMPAVANJE.
NOVA GENERACIJA EINHELL POVRŠINSKIH PUMPI.

■ INOVATIVNE ZNAČAJKE

- Brzo i jednostavno pokretanje i rješavanje problema zahvaljujući indikatorima statusa
- Dugi radni vijek, niski troškovi održavanja i izuzetna sigurnost pri radu zahvaljujući posebnoj zaštiti i sigurnosnim mehanizmima

■ JOŠ BOLJI UČINAK UZ MANJU POTROŠNJU ENERGIJE

Novi koncept vrtnih pumpi PLUS, automatskih vrtnih pumpi PLUS i hidropaka PLUS sastoji se od ove dvije prednosti:

1. INDIKATORI STATUSA

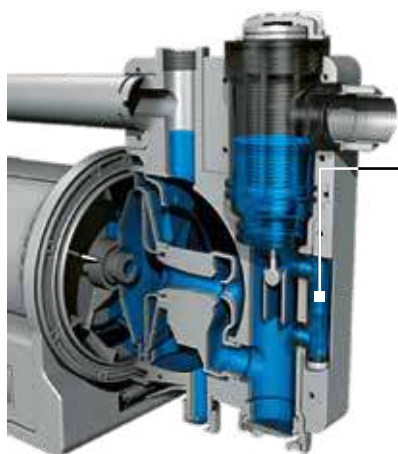

EXPERT verzija

INDIKATOR RAZINE VODE

Prije prvog puštanja svaku pumpu potrebno je napuniti vodom kako bi se mogla pravilno pokrenuti. Zahvaljujući kontrolnom staklu, na prvi pogled možete vidjeti da li je pumpa napunjena vodom.



CLASSIC verzija

PREFILTER

Jednostavno se skida za potrebe čišćenja ili zamjenu.



VELIKI OTVOR ZA PUNJENJE

Za jednostavnije punjenje pumpe.



INDIKATOR USISAVANJA

U poklopcu otvora za punjenje vode nalazi se manometar, koji pruža informacije o trenutnom tlaku usisavanja ili visini usisavanja.

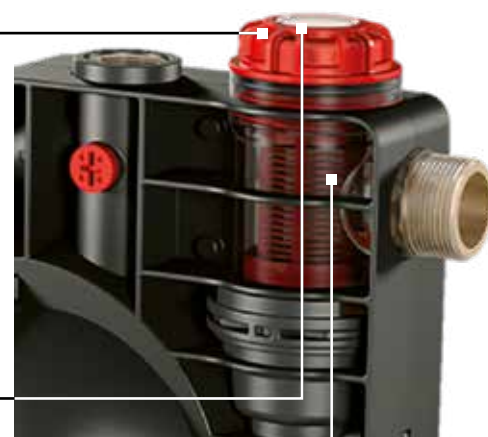

INDIKATOR NEČISTOĆE

Zahvaljujući prozirnomo kućištu oko predfiltera, jednostavno je vidjeti je li filter prljav i treba li ga očistiti.

SEGMENTACIJA ZNAČAJKI

	EXPERT	CLASSIC
Vrtne pumpe	GE-GP 1145 ECO GE-GP 1246 N FS	GC-GP 6040 ECO GC-GP 1045 GC-GP 1250 N
Automatske vrtne pumpe	GE-AW 1042 FS GE-AW 1246 N FS	–
Hidropaci	GE-WW 1145 ECO GE-WW 1246 N FS	GC-WW 1045 N

INDIKATORI STATUSA

Indikator razine vode*	•	•
Indikator usisavanja*	•	–
Indikator nečistoće (Predfilter s nepovratnim ventilom)	•	–

SIGURNOST I PREVENCIJA

Senzor protoka vode	• (izuzev GE-GP/WW 1145 ECO)	–
Zaštita od rada na suho	• (izuzev GE-GP/WW 1145 ECO)	–
Zaštita od vrenja	• (izuzev GE-GP/WW 1145 ECO)	–
Termo zaštita	•	•
Zaštita od smrzavanja	•	•

*Patent podnesen

2. SIGURNOST I PREVENCIJA

ZAŠTITA OD VRENJA



Ako dođe do blokade na tlačnoj strani i pumpa nastavi raditi, voda koja ostane u pumpi će se zagrijati. Da se korisnik ne bi zalio vrućom vodom prilikom provjere pumpe, zaštita od vrenja isključuje pumpu.

ZAŠTITA OD SMRZAVANJA

Često korisnici zaborave isprazniti pumpu prije zime, a smrznuta voda uništi pumpu. Da bi se spriječilo smrzavanje vode postoji prikladan vijak za odvod vode s kojim se voda može vrlo brzo ispustiti.

SENZOR PROTOKA VODE

Senzor koji mjeri protok vode (LED).

-  **Crveno:** Kvar – nema vode u pumpi
-  **Žuto:** Detekcija protoka
-  **Zeleno:** Pumpa radi normalno

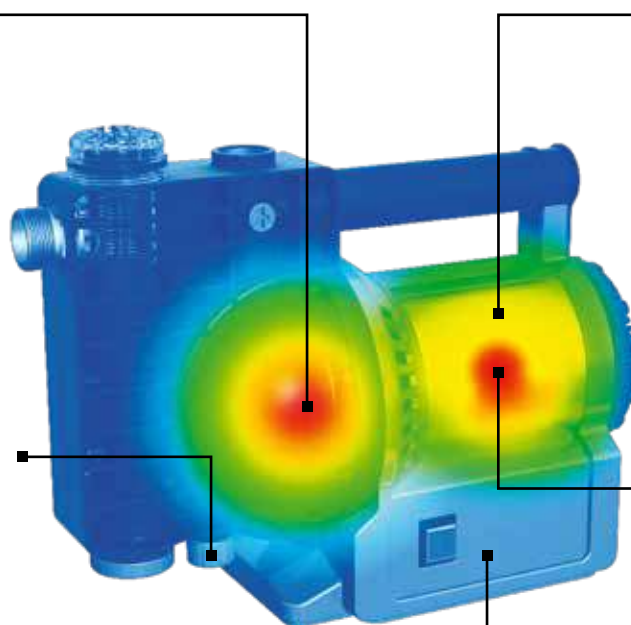

ZAŠTITA

OD RADA NA SUHO

Kada pumpa više ne može usisavati vodu (npr. prazan izvor vode), zaštita od rada na suho to prepoznaje i zaustavlja pumpu. Pokušava ponovo pokrenuti pumpu, a ako još uvijek nema vode za usisavanje, pumpa se ponovno isključuje. Time se sprječava pregrijavanje pumpe, a time i pregrijavanje motora.

TERMO ZAŠTITA

Da bi se spriječila velika oštećenja, termo prekidač isključuje pumpu kada se motor pregrije.



VRTNE PUMPE PLUS

INDIKATOR USISAVANJA

Pružna informacije o trenutnoj visini usisavanja/usisnom tlaku ili mogućim problemima usisavanja

VISOKOKVALITETNI NAVOJI

Dugi vijek trajanja navoja i pumpe

INDIKATOR NEČISTOĆE

Moguća kontaminacija filtera može se vidjeti na prvi pogled

INDIKATOR RAZINE VODE

Na prvi pogled vidljivo da li je i koliko vode u pumpi

ZAŠTITA OD SMRZAVANJA

Jednostavan odvod zaostale vode i zaštita od smrzavanja zahvaljujući vijku za odvod vode

PRIKLJUČAK ZA DODATNI TLAK

Za rad više potrošača istovremeno



Vrtna pumpa Plus
GE-GP 1246 N FS

ZAŠTITA OD RADA NA SUHO I ZAŠTITA OD VRENJA

Stalnim nadzorom protoka vode pumpa je zaštićena od rada na suho ili zagrijavanja vode unutar pumpe - to može spriječiti dugotrajnu štetu

VRTNE PUMPE PLUS



	GE-GP 1246 N FS EXPERT	GE-GP 1145 ECO EXPERT
Napon	220 - 240 V ~ 50 Hz	220 - 240 V ~ 50 Hz
Snaga	1200 W	1100 W
Maks. dostavni kapacitet / maks. dostavna visina	4600 l/h / 50 m	4500 l/h / 48 m
Maks. usisna visina	8 m	8 m
Usisni priključak	42 mm (1 1/4") VN	42 mm (1 1/4") VN
Tlačni priključak	33,3 mm (1") UN	33,3 mm (1") UN
Dodatni tlačni priključak	33,3 mm (1") UN	33,3 mm (1") UN
Strujni kabel	1,5 m	1,5 m
Težina proizvoda	14,0 kg	14,0 kg
Otvor za ulijevanje vode	•	•
Indikator razine vode / prljavštine / usisavanja	• / • / •	• / • / •
Predfilter s nepovratnim ventilom	•	•
Ručka za nošenje	Comfort	Comfort
Zaštita od smrzavanja zahvaljujući čepu za odvod vode	•	•
Termo zaštita	•	•
Zaštita od rada na suho i od vrenja / senzor protoka	• / • / •	- / - / -
ECO Power	-	•
Uklj. adapter 33,3 mm (1") VN	•	•
Broj artikla	41.803.60	41.803.70



VRTNE PUMPE PLUS



	GC-GP 1250 N/1 CLASSIC	GC-GP 1045 CLASSIC
Napon	220 - 240 V ~ 50 Hz	220 - 240 V ~ 50 Hz
Snaga	1200 W	1050 W
Maks. dostavni kapacitet / maks. dostavna visina	5000 l/h / 50 m	4500 l/h / 48 m
Maks. usisna visina	8 m	8 m
Usisni priključak	42 mm (1¼") VN	42 mm (1¼") VN
Tlačni priključak	33,3 mm (1") UN	33,3 mm (1") UN
Dodatni tlačni priključak	-	-
Strujni kabel	1,5 m	1,5 m
Težina proizvoda	9,7 kg	9,5 kg
Otvor za ulijevanje vode	•	•
Indikator razine vode / prljavštine / usisavanja	• / - / -	• / - / -
Predfilter s nepovratnim ventilom	-	-
Ručka za nošenje	Comfort	Comfort
Zaštita od smrzavanja zahvaljujući čepu za odvod vode	•	•
Termo zaštita	•	•
ECO Power	-	-
Uklj. adapter 33,3 mm (1") VN	•	•
Broj artikla	41.803.50	41.803.40



4 006825 637281



4 006825 637274

VRTNE PUMPE PLUS



	GC-GP 6040 ECO CLASSIC
Napon	220 - 240 V ~ 50 Hz
Snaga	600 W
Maks. dostavni kapacitet / maks. dostavna visina	4000 l/h / 36 m
Maks. usisna visina	8 m
Usisni priključak	42 mm (1¼") VN
Tlačni priključak	33,3 mm (1") UN
Dodatni tlačni priključak	-
Strujni kabel	1,5 m
Težina proizvoda	6,1 kg
Otvor za ulijevanje vode	•
Indikator razine vode / prljavštine / usisavanja	• / - / -
Predfilter s nepovratnim ventilom	-
Ručka za nošenje	Sklopiva
Zaštita od smrzavanja zahvaljujući čepu za odvod vode	•
Termo zaštita	•
ECO Power	•
Uklj. adapter 33,3 mm (1") VN	•
Broj artikla	41.803.20



4 006825 637250

**VRTNE PUMPE DOSTUPNE
SU U AKUMULATORSKOJ
IZVEDBI.**

VIŠE NA 54. STRANICI



VRTNE PUMPE



	GC-GP 6538 CLASSIC	GC-GP 6538 Set CLASSIC	GC-GP 6538 Set/I CLASSIC
Napon	220 - 240 V ~ 50 Hz	220 - 240 V ~ 50 Hz	220 - 240 V ~ 50 Hz
Snaga	650 W	650 W	650 W
Maks. dostavni kapacitet / maks. dostavna visina	3800 l/h / 36 m	3800 l/h / 36 m	3800 l/h / 36 m
Maks. usisna visina	8 m	8 m	8 m
Usisni priključak	33,3 mm (1") VN	33,3 mm (1") VN	33,3 mm (1") VN
Tlačni priključak	33,3 mm (1") VN	33,3 mm (1") VN	33,3 mm (1") VN
Strujni kabel	1,4 m	1,4 m	1,4 m
Težina proizvoda	6,1 kg	6,1 kg	6,1 kg
Otvor za ulijevanje vode	•	•	•
Otvor za ispuštanje vode	•	•	•
Visokokvalitetno mehaničko brtvljenje	•	•	•
Predfilter s nepovratnim ventilom	-	-	-
Ručka za nošenje	•	•	•
Uključeno usisno crijevo	-	• (7 m)	• (4 m)
Broj artikla	41.802.80	41.802.83	41.802.86



4 006825 603477



4 006825 611168



4 006825 638875

VRTNE PUMPE



	GC-GP 6036 CLASSIC	GC-TP 4622 CLASSIC
Napon	230 V ~ 50 Hz	220 - 240 V ~ 50 Hz
Snaga	600 W	460 W
Maks. dostavni kapacitet / maks. dostavna visina	3600 l/h / 40 m	2250 l/h / 37 m
Maks. usisna visina	8 m	-
Usisni priključak	33,3 mm (1") UN	33,3 mm (1") UN
Tlačni priključak	33,3 mm (1") UN	33,3 mm (1") UN
Strujni kabel	1,5 m	1,5 m
Težina proizvoda	9,5 kg	6,1 kg
Otvor za ulijevanje vode	•	•
Otvor za ispuštanje vode	•	•
Visokokvalitetno mehaničko brtvljenje	-	-
Predfilter s nepovratnim ventilom	-	-
Ručka za nošenje	•	-
Uključeno usisno crijevo	-	-
Broj artikla	41.802.69	41.834.00



4 006825 623567



4 006825 643947

AUTOMATSKA VRTNA PUMPA SMART



Automatska vrtna pumpa Smart
GE-AW 1144 SMART



AUTOMATSKA VRTNA PUMPA SMART



GE-AW 1144 SMART

EXPERT

NOVO

Napon	220 - 240 V ~ 50 Hz
Snaga	1100 W
Maks. dostavni kapacitet / visina	4400 l/h / 48 m
Maks. radni tlak	4,8 bara
Maks. usisna visina	8 m
Usisni priključak	42 mm (1 1/4") VN
Tlačni priključak	33,3 mm (1") UN
Strujni kabel	1,5 m
Težina proizvoda	11,4 kg
Aplikacija	GSM / Smart
Podešavanje dnevnog radnog vremena	•
Zakazivanje na temelju vremenskih prilika	•
Povezivanje s Einhell Smart uređajima	•
Automatska funkcija	•
Zaštita od rada na suho	•
Indikator	LED
Otvor za ulijevanje vode	•
Otvor za ispuštanje vode	•
Predfilter s nepovratnim ventilom	•
Termo zaštita	•
Broj artikla	41.803.80



PAMETNI NAČIN RADA

U pametnom načinu rada pumpa automatski stvara raspored koji je optimalno prilagođen vremenskim prilikama i željama korisnika



PREPOZNAVANJE VREMENSKIH PRILIKA

Vremenski podaci dobivaju se u stvarnom vremenu za trenutnu lokaciju i vrijeme navodnjavanja se prilagođava u skladu s tim



RASPORED VREMENA RADA

Pumpa započinje svoj rad prema unaprijed definiranom rasporedu



POVEZIVO S EINHELL SMART (PAMETNIM) UREĐAJIMA

Einhell Smart (pametni) uređaji automatski koordiniraju jedni s drugima u Smart (pametnom) načinu rada



PRISTUP IZ DALJINE

S pametnim telefonom navodnjavanje je sada moguće s bilo kojeg mjesta, zahvaljujući izravnoj internetskoj vezi uređaja putem mobilne mreže



NIJE POTREBAN WI-FI ILI BLUETOOTH

Nema više ograničenja zbog Bluetooth ili WLAN dometa. Komunikacija putem mobilne mreže (bez dodatnih troškova!)

Još jedan SMART uređaj iz Einhell asortimana:

Power X-Change robotska kosilica FREELEXO SMART 750 (vidi str. 13.)



AUTOMATSKE VRTNE PUMPE PLUS



	GE-AW 1246 N FS EXPERT	GE-AW 1042 FS EXPERT
Napon	220 - 240 V ~ 50 Hz	220 - 240 V ~ 50 Hz
Snaga	1200 W	1050 W
Maks. dostavni kapacitet / maks. dostavna visina	4600 l/h / 50 m	4200 l/h / 48 m
Maks. radni tlak	5,0 bara	4,8 bara
Maks. usisna visina	8 m	8 m
Usisni priključak	42 mm (1¼") VN	42 mm (1¼") VN
Tlačni priključak	33,3 mm (1") UN	33,3 mm (1") UN
Dodatni tlačni priključak	33,3 mm (1") UN	33,3 mm (1") UN
Strujni kabel	1,5 m	1,5 m
Težina proizvoda	15,0 kg	15,0 kg
Automatska funkcija	•	•
Timer funkcija - vremenski brojač	•	-
Otvor za ulijevanje vode	•	•
Indikator razine vode / prljavštine / usisavanja	• / • / •	• / • / •
Predfilter s nepovratnim ventilom	•	•
Ručka za nošenje	Comfort	Comfort
Zaštita od smrzavanja zahvaljujući čepu za odvod vode	•	•
Termo zaštita	•	•
Zaštita od rada na suho i od vrenja / senzor protoka	• / • / •	• / • / •
Uklj. adapter 33,3 mm (1") VN	•	•
Broj artikla	41.770.20	41.770.10



4 006825 642476



4 006825 642469

AUTOMATSKA VRTNA PUMPA



	GC-AW 6333 CLASSIC
Napon	230 V ~ 50 Hz
Snaga	630 W
Maks. dostavni kapacitet / maks. dostavna visina	3300 l/h / 36 m
Maks. radni tlak	3,6 bara
Maks. usisna visina	8 m
Usisni priključak	42 mm (1¼") VN
Tlačni priključak	33,3 mm (1") UN
Strujni kabel	1,5 m
Težina proizvoda	7,8 kg
Automatska funkcija	•
Timer funkcija - vremenski brojač	-
Zaštita od rada na suho	•
Indikator	LED
Otvor za ulijevanje vode	•
Otvor za ispuštanje vode	•
ECO Power	-
Predfilter s nepovratnim ventilom	•
Ručka za nošenje	•
Broj artikla	41.767.30



4 006825 609226

HIDROPACI PLUS

INDIKATOR USISAVANJA

Pružna informacije o trenutnoj usisnoj visini/usisnom tlaku ili mogućim problemima s usisavanjem

VISOKOKVALITETNI NAVOJI

Dugi vijek trajanja navoja i pumpe

INDIKATOR NEČISTOĆE

Moguća kontaminacija filtera može se vidjeti na prvi pogled

INDIKATOR RAZINE VODE

Na prvi pogled vidljivo da li je i koliko vode u pumpi

ZAŠTITA OD SMRZAVANJA

Jednostavan odvod zaostale vode i zaštita od smrzavanja zahvaljujući čepu za odvod vode

DODATNI TLAČNI PRIKLJUČAK

Za istovremeni rad više potrošača

Hidropak Plus
GE-WW 1145 ECO

INTEGRIRANI MANOMETAR

Trenutni tlak može se očitati na prvi pogled

SPREMNIK 20L

Veliki spremnik za stalnu opskrbu vodom



HIDROPACI PLUS

**20 l
TANK**



	GE-WW 1246 N FS EXPERT	GE-WW 1145 ECO EXPERT
Napon	220 - 240 V ~ 50 Hz	220 - 240 V ~ 50 Hz
Snaga	1200 W	1100 W
Maks. dostavni kapacitet / maks. dostavna visina	4600 l/h / 50 m	4500 l/h / 48 m
Maks. usisna visina	8 m	8 m
Usisni priključak	42 mm (1¼") VN	42 mm (1¼") VN
Tlačni priključak	33,3 mm (1") UN	33,3 mm (1") UN
Dodatni tlačni priključak	33,3 mm (1") UN	33,3 mm (1") UN
Kapacitet spremnika	20 l	20 l
Maks. tlak uklj. / isklj.	1,5 bara / 3 bara	1,5 bara / 3 bara
Strujni kabel	1,5 m	1,5 m
Težina proizvoda	19,5 kg	19,5 kg
Otvor za ulijevanje vode	•	•
Indikator razine vode / prljavštine / usisavanja	• / • / •	• / • / •
Predfilter s nepovratnim ventilom	•	•
Ručka za nošenje	Comfort	Comfort
Zaštita od smrzavanja zahvaljujući čepu za odvod vode	•	•
Termo zaštita	•	•
Zaštita od rada na suho i od vrenja / senzor protoka	• / • / •	- / - / -
Uklj. adapter 33,3 mm (1") VN	•	•
Broj artikla	41.735.30	41.735.40



4 006825 640373



4 006825 647891

HIDROPAK PLUS



	GC-WW 1045 N CLASSIC
Napon	220 - 240 V ~ 50 Hz
Snaga	1050 W
Maks. dostavni kapacitet / maks. dostavna visina	4500 l/h / 48 m
Maks. usisna visina	8 m
Usisni priključak	42 mm (1¼") VN
Tlačni priključak	33,3 mm (1") UN
Dodatni tlačni priključak	-
Kapacitet spremnika	20 l
Maks. tlak uklj. / isklj.	1,5 bara / 3 bara
Strujni kabel	1,5 m
Težina proizvoda	17,3 kg
Otvor za ulijevanje vode	•
Indikator razine vode / prljavštine / usisavanja	• / - / -
Predfilter s nepovratnim ventilom	-
Ručka za nošenje	Comfort
Zaštita od smrzavanja zahvaljujući čepu za odvod vode	•
Termo zaštita	•
Uklj. adapter 33,3 mm (1") VN	•
Broj artikla	41.735.20



4 006825 637304

HIDROPAK



GC-WW 1250 NN CLASSIC	
Napon	220 - 240 V ~ 50 Hz
Snaga	1200 W
Maks. dostavni kapacitet / maks. dostavna visina	5000 l/h / 50 m
Maks. usisna visina	8 m
Kapacitet spremnika	20 l
Maks. tlak uklj. / isklj.	1,5 bara / 3 bara
Usisni priključak	42 mm (1½") VN
Tlačni priključak	33,3 mm (1") UN
Strujni kabel	1,5 m
Težina proizvoda	14,7 kg
Zaštita od preopterećenja	•
Otvor za ulijevanje vode	•
Otvor za ispuštanje vode	•
Visokokvalitetno mehaničko brtvljenje	•
INOX spremnik	•
Predfilter s nepovratnim ventilom	-
Manometar	•
Uključeno usisno crijevo	-
Broj artikla	41.734.90



HIDROPACI



GC-WW 6538 CLASSIC		GC-WW 6538 Set CLASSIC		GC-WW 6036 CLASSIC	
Napon	220 - 240 V ~ 50 Hz	220 - 240 V ~ 50 Hz		230 V ~ 50 Hz	
Snaga	650 W	650 W		600 W	
Maks. dostavni kapacitet / maks. dostavna visina	3800 l/h / 36 m	3800 l/h / 36 m		3600 l/h / 40 m	
Maks. usisna visina	8 m	8 m		8 m	
Kapacitet spremnika	20 l	20 l		20 l	
Maks. tlak uklj. / isklj.	1,5 bara / 3 bara	1,5 bara / 3 bara		1,5 bara / 3 bara	
Usisni priključak	33,3 mm (1") VN	33,3 mm (1") VN		33,3 mm (1") UN	
Tlačni priključak	33,3 mm (1") VN	33,3 mm (1") VN		33,3 mm (1") UN	
Strujni kabel	1,4 m	1,4 m		1,5 m	
Težina proizvoda	10,5 kg	10,5 kg		14,3 kg	
Zaštita od preopterećenja	•	•		•	
Otvor za ulijevanje vode	•	•		•	
Otvor za ispuštanje vode	•	•		-	
Visokokvalitetno mehaničko brtvljenje	•	•		-	
Manometar	•	•		•	
Uključeno usisno crijevo	-	7 m		-	
Broj artikla	41.731.90	41.731.93		41.731.18	



MOTORNE PUMPE ZA VODU



	GE-PW 46 EXPERT	GC-PW 16 CLASSIC
Motor	4-taktni	4-taktni
Snaga kW / KS	4,6 / 6,3	1,6 / 2,2
Maks. dostavni kapacitet / maks. dostavna visina	23000 l/h / 26 m	14000 l/h / 28 m
Maks. usisna visina	6,5 m	7,0 m
Maks. brzina	3600 min ⁻¹	3600 min ⁻¹
Usisni priključak	59,6 mm (2") VN	47,8 mm (1½") VN
Tlačni priključak	59,6 mm (2") VN	47,8 mm (1½") VN
Kapacitet spremnika goriva	3,6 l	1,8 l
Težina proizvoda	21,8 kg	15,5 kg
Nepovratni ventil	•	•
Čvrsti okvir od čeličnih cijevi	•	-
Otvor za ulijevanje vode	•	•
Otvor za ispuštanje vode	•	•
Otvor za ulijevanje ulja	•	•
Zaštita od niske razine ulja	•	•
Uključen adapter crijeva	2x 50,8 mm (2")	2x 38,1 mm (1,5")
Uključena usisna košara	• (2")	• (1,5")
Uključeni reduktori	2x 47,8 mm (1,5") VN, 2x 33,3 mm (1") VN	-
Broj artikla	41.713.72	41.905.30



4 006825 643978



4 006825 644678



PRIBOR



PRIBOR ZA POVRŠINSKE PUMPE



	Usisno crijevo 4 m, mesing	Usisno crijevo 4 m	Usisno crijevo 7 m, mesing	Usisno crijevo 7 m
Duljina	4 m	4 m	7 m	7 m
Materijal priključka	Mesing	Plastika	Mesing	Plastika
Priključak	42 mm (1¼") UN	42 mm (1¼") UN	42 mm (1¼") UN	42 mm (1¼") UN
Promjer crijeva	25 mm (1")	25 mm (1")	25 mm (1")	25 mm (1")
Navojni priključak	33,3 mm (1") VN	33,3 mm (1") VN	33,3 mm (1") VN	33,3 mm (1") VN
Adapter	33,3 mm (1") UN	33,3 mm (1") UN	33,3 mm (1") UN	33,3 mm (1") UN
Broj artikla	41.736.30	41.736.35	41.736.40	41.736.45



4 006825 549133



4 006825 549058



4 006825 549171



4 006825 549102



	Predfilter 12 cm	Predfilter 25 cm
Visina filtera	12 cm	25 cm
Uklj. uložak	•	•
Broj artikla	41.738.01	41.738.51



4 006825 549188



4 006825 549195



	Elektronski prekidač protoka
Maks. radni tlak	11 bara
Maks. temperatura vode	55°C
Nepovratni ventil	•
Integrirana zaštita od rada na suho	•
Broj artikla	41.742.30











NOVO





4 006825 667738

PRIBOR ZA TRIMERE ZA TRAVU

Noževi

	Oznaka tipa	Pogodan za	Provrt	Debljina materijala	Promjer	Odgovara za	Broj artikla
	Specijalni nož za travu 230	 Trava i raslinje	25,4 mm	1,4 mm	230 mm	 <p>Sve trimere iz trenutnog asortimana</p>	34.366.60
	Nož za gustu vegetaciju 255	 Samoniklo raslinje, šikare i makija	25,4 mm	2,5 mm	255 mm		34.050.82
	Nož za gustu vegetaciju 200	 Samoniklo raslinje, šikare i makija	25,4 mm	2,0 mm	200 mm		34.050.83
	Nož za travu 255	 Visoka trava i gusto raslinje	25,4 mm	1,4 mm	255 mm		34.049.96
	Nož za travu 230	 Visoka trava i gusto raslinje	25,4 mm	1,4 mm	230 mm		34.366.61

Špule s reznom niti

	Višenamjenski vrtni alati		Trimeri za travu						Trimeri za travu						Broj artikla			
	GC-MM 52 I AS	GE-LM 36/4in1 Li	AGILLO 36/255	AGILLO 18/200	GC-BC 36-4 S	GC-BC 52 I AS	GH-BC 43 AS	GC-BC 30/1 I AS	GC-BC 25/1 I AS	GE-CT 36/30 Li E	GE-CT 18/30 Li	GE-CT 18/28 Li TC	GE-CT 18/28 Li	GC-ET 4530		GC-ET 3023	GC-ET 2522	GC-PT 2538/1 I AS
																		34.050.75
	•					•	•	•	•							•		34.050.86
		•	•	•						•								34.050.96
											•	•						34.051.16
											•							34.051.17
																	•	34.052.20
						•												34.052.40
														•				34.056.85
														•				34.056.95

Rezne niti

BASIC LINE	Boja	Opis	Oblik	Ø	Duljina	Broj artikla
	Siva	Standardna rezna nit	●	1,3 mm	15 m	34.366.50
				1,6 mm	15 m	34.366.51
				2,0 mm	15 m	34.366.52

SUPER CUT LINE	Boja	Opis	Oblik	Ø	Duljina	Broj artikla
	Crna	Optimalan oblik rezanja zahvaljujući oštrim rubovima	■	2,0 mm	15 m	34.366.53
				2,4 mm	15 m	34.366.54
				3,0 mm	15 m	34.366.56

LOW NOISE LINE	Boja	Opis	Oblik	Ø	Duljina	Broj artikla
	Crvena	Smanjena razina buke	●	2,4 mm	15 m	34.366.55
				3,0 mm	15 m	34.366.57

POWER X-CHANGE

		ROBOTSKE KOSILICE							KOSILICE / AKUMULATORSKJE KOSILICE				
		FREELEXO CAM 500	FREELEXO 300 LCD BT+	FREELEXO 500 LCD BT+	FREELEXO 600 BT	FREELEXO SMART 750	FREELEXO 900 LCD BT	FREELEXO 1200 LCD BT	GC-PM 51/3 S HW-E Li	GC-PM 46 SM HW-E Li	RASARRO 36/42	RASARRO 36/40	RASARRO 36/38
Baterija Power X-Change 1,5 Ah	Ne prodaje se zasebno - samo kao dio seta		•						•	•			
Baterija Power X-Change 2,0 Ah			•						•	•			
Baterija Power X-Change 2,5 Ah			•	•	•				•	•	•	•	•
Baterija Power X-Change 3,0 Ah	Ne prodaje se zasebno - samo kao dio seta	•	•	•	•	•	•		•	•	•	•	•
Baterija Power X-Change Plus 3,0 Ah		•	•	•	•	•	•		•	•	•	•	•
Baterija Power X-Change 4,0 Ah		•	•	•	•	•	•		•	•	•	•	•
Baterija Power X-Change Plus 4,0 Ah	Dostupno samo kao Twin-Pack set	•	•	•	•	•	•		•	•	•	•	•
Baterija Power X-Change Plus 5,2 Ah		•	•	•	•	•	•	•	•	•	•	•	•
Baterija Power X-Change 4-6 Multi Ah		•	•	•	•	•	•	•	•	•	•	•	•
Baterija Power X-Change 5-8 Multi Ah		•	•	•	•	•	•	•	•	•	•	•	•
Punjač Power X-Charger 3 A	Ne prodaje se zasebno - samo kao dio seta	•	•	•	•	•	•	•	•	•	•	•	•
Punjač Power X-Fastcharger 4 A		•	•	•	•	•	•	•	•	•	•	•	•
Punjač Power X-Twincharger 3 A		•	•	•	•	•	•	•	•	•	•	•	•
Punjač Power X-Boostcharger 6 A		•	•	•	•	•	•	•	•	•	•	•	•
Punjač Power X-Quattrocharger 4 A		•	•	•	•	•	•	•	•	•	•	•	•
Punjač Power X-Car Charger 6 A		•	•	•	•	•	•	•	•	•	•	•	•

POWER X-CHANGE

		AKUMULATORSKJE ŠKARE ZA ŽIVCU							AKU TRESAČ MASLINA I PLODOVA		AKU VIŠENAMJENSKI ALATI	
		GE-CH 36/65 Li	GE-CH 36/61 Li	GE-CH 18/60 Li	ARCURRA 18/55	GC-CH 1855/1 Li	GC-CH 18/50 Li	GC-CH 18/46 Li	GC-CH 18/40 Li	GE-FS 18/53 Li	GE-LM 36/4in1 Li T	GE-HC 18 Li T
Baterija Power X-Change 1,5 Ah	Ne prodaje se zasebno - samo kao dio seta	•	•	•	•	•	•	•	•	•	•	
Baterija Power X-Change 2,0 Ah		•	•	•	•	•	•	•	•	•	•	
Baterija Power X-Change 2,5 Ah		•	•	•	•	•	•	•	•	•	•	•
Baterija Power X-Change 3,0 Ah	Ne prodaje se zasebno - samo kao dio seta	•	•	•	•	•	•	•	•	•	•	•
Baterija Power X-Change Plus 3,0 Ah		•	•	•	•	•	•	•	•	•	•	•
Baterija Power X-Change 4,0 Ah		•	•	•	•	•	•	•	•	•	•	•
Baterija Power X-Change Plus 4,0 Ah	Dostupno samo kao Twin-Pack Set	•	•	•	•	•	•	•	•	•	•	•
Baterija Power X-Change Plus 5,2 Ah		•	•	•	•	•	•	•	•	•	•	•
Baterija Power X-Change 4-6 Multi Ah		•	•	•	•	•	•	•	•	•	•	•
Baterija Power X-Change 5-8 Multi Ah		•	•	•	•	•	•	•	•	•	•	•
Punjač Power X-Charger 3 A	Ne prodaje se zasebno - samo kao dio seta	•	•	•	•	•	•	•	•	•	•	•
Punjač Power X-Fastcharger 4 A		•	•	•	•	•	•	•	•	•	•	•
Punjač Power X-Twincharger 3 A		•	•	•	•	•	•	•	•	•	•	•
Punjač Power X-Boostcharger 6 A		•	•	•	•	•	•	•	•	•	•	•
Punjač Power X-Quattrocharger 4 A		•	•	•	•	•	•	•	•	•	•	•
Punjač Power X-Car Charger 6 A		•	•	•	•	•	•	•	•	•	•	•

Podaci u tablici Power X-Change pribora predstavljaju preporučene kapacitete baterija za savršene rezultate rada.

AKUMULATORSKE KOSILICE	
RASARRO 36/36	
RASARRO 36/34	
GP-CM 36/47 SHW Li	
GE-CM 36/48 Li M	
GE-CM 36/43 Li M	
GP-CM 36/41 Li	
GE-CM 36/37 Li	
GE-CM36/36 Li	
GE-CM 36/34-1 Li	
GE-CM 36/33 Li	
GE-CM 18/33 Li	
GE-CM 18/32 Li	
GE-CM 18/30 Li	
GE-HM 18/38 Li	
GE-US 18 Li	
GE-SC 35/35 Li	
GE-SA 36/35 Li	
GC-SC 36/31 Li	
GC-SC 18/28 Li	
GP-EA 18/150 Li BL	
GE-ST 36/40 Li E	
GE-CR 30 Li	
GE-CR 18/20 Li E	
AGILLO 36/255 BL	
AGILLO 18/200	
GE-CT 36/30 Li E	
GE-CT 18/30 Li	
GE-CT 18/28 Li TC	
GE-CT 18/28 Li	
GE-CT 18 Li	
GE-CT 18/24 Li	
GE-CT 18/24 Li P	
GE-LE 18/190 Li	
GC-CC 18 Li	
PICOBELLA	

AKU TELESKOPSKE LANČANE PILE	
GE-LC 18 Li T	
GC-LC 18/20 Li T	
GE-HH 18/45 Li T	
GC-HH 18/45 Li T	
GP-LC 36/35 Li	
FORTEXXA 18/30	
FORTEXXA 18/20 TH	
GE-LC 18/25-1 Li	
GE-LC 18/25 Li	
GE-CS 18 Li	
GP-LB 36/210 Li E	
GP-LB 18/200 Li GK	
GP-LB 18/200 Li E	
GC-CL 18 Li E	
GE-UB 18/250 Li E	
VENTURRO 36/240	
VENTURRO 18/210	
GE-CL 36 Li E	
GE-CL 36/230 Li E	
GE-CG 18/100 Li T	
GE-CG 18/100 Li	
GC-CG 18 Li	
GC-CG 18/1 Li	
GE-GS 18/150 Li	
GE-LS 18 Li	
GE-WS 18/150 Li	
GE-WS 18/75 Li	
GE-WS 18/35 Li	
GE-WS 18/10 Li	
GE-CF 18/2200 Li	
GE-HG 18/370 Ni-ro Li	
AQUINNA 18/30 F LED	
AQUINNA 18/28	
AQUINNA 36/38 F LED AUTOMATC	
AQUINNA 36/38 F LED	
AQUINNA 36/30	
GE-PP 18 RB Li	
GE-SP 18 LL Li	
GE-SP 18 Li	
GE-DP 18/25 Li	
GE-DP 18/25 LL Li	

AKUMULATORSKI OSTRAC LANACA	
AKUMULATORSKI PUHAČI LIŠĆA	
AKU UNIVERZALNI PUHAČ	
AKUMULATORSKI USISAVACI / PUHAČI LIŠĆA	
AKUMULATORSKE ŠKARE ZA TRAVU I GRMLJE	
AKU PILA ZA GRANE	
AKU ŠKARE ZA OBREZIVANJE	
AKUMULATORSKE TLAČNE PRSKALICE	
AKU VENTILATOR	
AKU PLINSKI GRIJAČ	
AKUMULATORSKE VRTNE PUMPE	
AKUMULATORSKE POTOPNE PUMPE ZA ČISTU VODU	
AKU POTOPNE PUMPE ZA NEČISTU VODU	





POWER X-CHANGE AKUMULATORSKA / ELEKTRIČNA / BENZINSKA / RUČNA KOSILICA

REZERVNI NOŽ

 KOMBINIRANI
NOŽ

 RAZ-
NO

Rezervni nož	34.045.53	4006825 633092	
Rezervni nož	34.054.10	4006825 649307	
Rezervni nož	34.054.20	4006825 602661	
Rezervni nož	34.054.30	4006825 595376	
Rezervni nož	34.054.40	4006825 595369	
Rezervni nož	34.054.51	4006825 610604	
Rezervni nož	34.054.52	4006825 610611	
Rezervni nož	34.054.53	4006825 645736	
Rezervni nož	34.054.54	4006825 651386	
Rezervni nož	34.054.55	4006825 631050	
Rezervni nož	34.054.56	4006825 662702	
Rezervni nož	34.054.85	4006825 584509	
Rezervni nož	34.054.86	4006825 635843	
Rezervni nož	34.056.05	4006825 541014	
Rezervni nož	34.056.10	4006825 541038	
Rezervni nož	34.056.60	4006825 605273	
Rezervni nož	34.058.25	4006825 630466	
Rezervni nož	34.058.30	4006825 630480	
Rezervni nož	34.058.50	4006825 638806	
Kombinirani nož	34.056.50	4006825 605266	
Kombinirani nož	34.056.70	4006825 605280	
Košara za sakupljanje trave	34.211.12	4006825 609707	

PROZRAČIVAČI TRAVE	RAZNO		Košara za sakupljanje trave 34.055.77 4006825 629699 4 006825 629699		
	PROZRAČIVANJE				Košara za sakupljanje trave 34.059.40 4006825 658798 4 006825 658798
	SKARIFIKACIJA				
BUŠILICA ZA ZEMlju	Valjak za prozračivanje 34.055.72 4006825 629675 4 006825 629675		Valjak za prozračivanje 34.059.41 4006825 658804 4 006825 658804		
	Valjak za prozračivanje 34.059.61 4006825 667516 4 006825 667516		Valjak za prozračivanje 34.211.25 4006825 575156 4 006825 575156		
	Valjak za prozračivanje 34.211.35 4006825 606331 4 006825 606331		Valjak za skarifikaciju 34.055.82 4006825 629682 4 006825 629682		
	Valjak za skarifikaciju 34.059.42 4006825 658811 4 006825 658811		Valjak za skarifikaciju 34.059.62 4006825 667509 4 006825 667509		
	Valjak za skarifikaciju 34.200.21 4006825 603309 4 006825 603309		Valjak za skarifikaciju 34.211.20 4006825 575149 4 006825 575149		
	Valjak za skarifikaciju 34.211.30 4006825 606324 4 006825 606324		Nastavak (1 m) 34.370.12 4006825 659054 4 006825 659054		
	Svrđlo za zemlju (120 mm) 34.370.10 4006825 659030 4 006825 659030		Mješalica žbuke 34.370.11 4006825 659047 4 006825 659047		
	Set rezervnih noževa za trimer (20 kom) 34.057.30 4006825 560404 4 006825 560404		Kutija rezervnih noževa za PXC trimere (50 kom) 34.057.36 4006825 646283 4 006825 646283		
	Rezervni nož 34.051.01 4006825 653533 4 006825 653533		Rezervna čelična četka (15 mm) 34.241.00 4006825 569919 4 006825 569919		
	Rezervna najlonska četka (10 mm) 34.241.10 4006825 569926 4 006825 569926		Rezervne četke od čelika (10 mm) i najlona (6 mm) 34.241.15 4006825 660760 4 006825 660760		
UREĐAJI ZA ČIŠĆENJE FUGA	Četka SOFT (drvo/umjetna trava) 34.241.21 4006825 646252 4 006825 646252		Četka MEDIUM (kamen) 34.241.20 4006825 646245 4 006825 646245		
	Četka ULTRA (kamen) 34.241.22 4006825 646269 4 006825 646269		Bočna četka ULTRA (kamen) 34.241.26 4006825 660845 4 006825 660845		
	Rezervni lanac 45.001.24 4006825 666632 4 006825 666632		Rezervni lanac 45.001.87 4006825 615463 4 006825 615463		
	Rezervni lanac 45.001.88 4006825 606355 4 006825 606355		Rezervni lanac 45.003.64 4006825 644616 4 006825 644616		
UREĐAJ ZA ČIŠĆENJE TERASA	Rezervni mač 45.001.17 4006825 569100 4 006825 569100		Rezervni mač 45.001.54 4006825 666625 4 006825 666625		
	Rezervni mač 45.001.67 4006825 615456 4 006825 615456		Rezervni mač 45.001.68 4006825 606348 4 006825 606348		
	Rezervni mač 45.001.68 4006825 606348 4 006825 606348		Rezervni mač 45.003.63 4006825 644609 4 006825 644609		
	Rezervni mač 45.003.63 4006825 644609 4 006825 644609		Rezervni mač 45.003.63 4006825 644609 4 006825 644609		
	Rezervni mač 45.003.63 4006825 644609 4 006825 644609		Rezervni mač 45.003.63 4006825 644609 4 006825 644609		
	Rezervni mač 45.003.63 4006825 644609 4 006825 644609		Rezervni mač 45.003.63 4006825 644609 4 006825 644609		

PROZRAČIVAČI TRAVE	
BUŠILICA ZA ZEMLJU	
TRIMERI ZA TRAVU	
TRIMER ZA RUBOVE TRAVNJAKA	
UREĐAJI ZA ČIŠĆENJE FUGA	
UREĐAJ ZA ČIŠĆENJE TERASA	
VIŠENAMJENSKI ALATI	
TELESKOPSKE LANČANE PILE	
GE-SC 36/35 Li	
GE-SA 36/35 Li	
GC-SC 36/31 Li	
GC-SC 18/28 Li Brushless	
GE-SA 1640	
GE-SA 1435	
GE-SA 1435/1	
GC-SA 1231/1	
GC-ES 1231/1	
GC-SC 4240 P	
GP-EA 18/150 Li Brushless	
GE-CT 18 Li	
GC-CT 18/24 Li	
GC-CT 18/24 Li P	
GE-LE 18/190 Li	
GC-CC 18 Li	
GC-EG 1410	
PICOBELLA	
GE-LM 36/4in1 Li Brushless	
GE-HC 18 Li T	
GC-MM 52 I AS	
GC-HC 90/2046 T	
GE-LC 18 Li T	
GC-LC 18/20 Li T	
GC-EC 7520 T	

NAVODNJEVANJE / ODVODNJA	RAZNO	LANČANE PILE / OŠTRAČI LANACA					
		MAČEVI	LANCI				
BRUSNE PLOČE		Rezervni lanac	45.001.71	4006825 548846	4 006825 548846		
		Rezervni lanac	45.001.72	4006825 600926	4 006825 600926		
		Rezervni lanac	45.001.73	4006825 663655	4 006825 663655		
		Rezervni lanac	45.001.76	4006825 548839	4 006825 548839		
		Rezervni lanac	45.001.92	4006825 663532	4 006825 663532		
		Rezervni lanac	45.001.93	4006825 664577	4 006825 664577		
		Rezervni lanac	45.001.96	4006825 632231	4 006825 632231		
		Rezervni lanac	45.003.13	4006825 663648	4 006825 663648		
		Rezervni lanac	45.003.20	4006825 578126	4 006825 578126		
		Rezervni lanac	45.017.54	4006825 607024	4 006825 607024		
		PUHAČI LIŠĆA		Rezervni mač	45.001.51	4006825 548907	4 006825 548907
				Rezervni mač	45.001.56	4006825 548778	4 006825 548778
Rezervni mač	45.001.58			4006825 663846	4 006825 663846		
Rezervni mač	45.001.91			4006825 663518	4 006825 663518		
Rezervni mač	45.001.94			4006825 664560	4 006825 664560		
Rezervni mač	45.001.97			4006825 632248	4 006825 632248		
Rezervni mač	45.003.32			4006825 546637	4 006825 546637		
Rezervni mač	45.003.44			4006825 594188	4 006825 594188		
Rezervni mač	45.017.53			4006825 607017	4 006825 607017		
KOPAČICA				Brusna ploča 4,5 mm	45.000.71	4006825 548853	4 006825 548853
				Brusna ploča 3,2 mm	45.000.76	4006825 548860	4 006825 548860
				Brusna ploča 4,5 mm Profi	45.999.80	4006825 552874	4 006825 552874
		Brusna ploča 3,2 mm Profi	45.999.90	4006825 552881	4 006825 552881		
		Set nastavaka za puhače lišća	34.335.59	4006825 660906	4 006825 660906		
		Plug	34.315.20	4006825 663419	4 006825 663419		
		Plug za krumpir	34.315.30	4006825 663426	4 006825 663426		
		Rezervni noževi za sjeckalice grana	34.059.30	4006825 595680	4 006825 595680		
		SJECKALICE		Elektronski prekidač protoka	41.742.30	4006825 667738	4 006825 667738
				Predfilter 12 cm	41.738.01	4006825 549188	4 006825 549188
				Predfilter 25 cm	41.738.51	4006825 549195	4 006825 549195
				Usisno crijevo 4 m, mesing	41.736.30	4006825 549133	4 006825 549133
Usisno crijevo 4 m, plastika	41.736.35			4006825 549058	4 006825 549058		
CRIJEVA		Usisno crijevo 7 m, mesing	41.736.40	4006825 549171	4 006825 549171		
		Usisno crijevo 7 m, plastika	41.736.45	4006825 549102	4 006825 549102		

PODRŠKA PRODAJI

POS | SHOP IN SHOP KONCEPT



■ Shop in Shop koncept Power X-Change vrt / alat 240 x 160 cm

TISKANI MATERIJAL



■ Letci



■ Brošure

POS | OSTALI PRODAJNI KONCEPTI



■ Modularni POS Power X-Change vrt / alat 120 x 80 cm



■ Kartonski POS Power X-Change alat 80 x 60 cm



■ Regalni POS Power X-Change alat

KALENDAR 2023

SIJEČANJ							
W.	P	U	S	Č	P	S	N
							1
1	2	3	4	5	6	7	8
2	9	10	11	12	13	14	15
3	16	17	18	19	20	21	22
4	23	24	25	26	27	28	29
5	30	31					

VELJAČA							
W.	P	U	S	Č	P	S	N
5			1	2	3	4	5
6	6	7	8	9	10	11	12
7	13	14	15	16	17	18	19
8	20	21	22	23	24	25	26
9	27	28					

OŽUJAK							
W.	P	U	S	Č	P	S	N
9			1	2	3	4	5
10	6	7	8	9	10	11	12
11	13	14	15	16	17	18	19
12	20	21	22	23	24	25	26
13	27	28	29	30	31		

TRAVANJ							
W.	P	U	S	Č	P	S	N
13						1	2
14	3	4	5	6	7	8	9
15	10	11	12	13	14	15	16
16	17	18	19	20	21	22	23
17	24	25	26	27	28	29	30

SVIBANJ							
W.	P	U	S	Č	P	S	N
18	1	2	3	4	5	6	7
19	8	9	10	11	12	13	14
20	15	16	17	18	19	20	21
21	22	23	24	25	26	27	28
22	29	30	31				

LIPANJ							
W.	P	U	S	Č	P	S	N
22				1	2	3	4
23	5	6	7	8	9	10	11
24	12	13	14	15	16	17	18
25	19	20	21	22	23	24	25
26	26	27	28	29	30		

SRPANJ							
W.	P	U	S	Č	P	S	N
26						1	2
27	3	4	5	6	7	8	9
28	10	11	12	13	14	15	16
29	17	18	19	20	21	22	23
30	24	25	26	27	28	29	30
31	31						

KOLOVOZ							
W.	P	U	S	Č	P	S	N
31		1	2	3	4	5	6
32	7	8	9	10	11	12	13
33	14	15	16	17	18	19	20
34	21	22	23	24	25	26	27
35	28	29	30	31			

RUJAN							
W.	P	U	S	Č	P	S	N
35					1	2	3
36	4	5	6	7	8	9	10
37	11	12	13	14	15	16	17
38	18	19	20	21	22	23	24
39	25	26	27	28	29	30	

LISTOPAD							
W.	P	U	S	Č	P	S	N
39							1
40	2	3	4	5	6	7	8
41	9	10	11	12	13	14	15
42	16	17	18	19	20	21	22
43	23	24	25	26	27	28	29
44	30	31					

STUDENI							
W.	P	U	S	Č	P	S	N
44			1	2	3	4	5
45	6	7	8	9	10	11	12
46	13	14	15	16	17	18	19
47	20	21	22	23	24	25	26
48	27	28	29	30			

PROSINAC							
W.	P	U	S	Č	P	S	N
48					1	2	3
49	4	5	6	7	8	9	10
50	11	12	13	14	15	16	17
51	18	19	20	21	22	23	24
52	25	26	27	28	29	30	31

BILJEŠKE

A series of horizontal dotted lines for writing notes.

KALENDAR 2024

SIJEČANJ

W.	P	U	S	Č	P	S	N
1	1	2	3	4	5	6	7
2	8	9	10	11	12	13	14
3	15	16	17	18	19	20	21
4	22	23	24	25	26	27	28
5	29	30	31				

VELJAČA

W.	P	U	S	Č	P	S	N
5				1	2	3	4
6	5	6	7	8	9	10	11
7	12	13	14	15	16	17	18
8	19	20	21	22	23	24	25
9	26	27	28	29			

OŽUJAK

W.	P	U	S	Č	P	S	N
9					1	2	3
10	4	5	6	7	8	9	10
11	11	12	13	14	15	16	17
12	18	19	20	21	22	23	24
13	25	26	27	28	29	30	31

TRAVANJ

W.	P	U	S	Č	P	S	N
14	1	2	3	4	5	6	7
15	8	9	10	11	12	13	14
16	15	16	17	18	19	20	21
17	22	23	24	25	26	27	28
18	29	30					

SVIBANJ

W.	P	U	S	Č	P	S	N
18			1	2	3	4	5
19	6	7	8	9	10	11	12
20	13	14	15	16	17	18	19
21	20	21	22	23	24	25	26
22	27	28	29	30	31		

LIPANJ

W.	P	U	S	Č	P	S	N
22						1	2
23	3	4	5	6	7	8	9
24	10	11	12	13	14	15	16
25	17	18	19	20	21	22	23
26	24	25	26	27	28	29	30

SRPANJ

W.	P	U	S	Č	P	S	N
27	1	2	3	4	5	6	7
28	8	9	10	11	12	13	14
29	15	16	17	18	19	20	21
30	22	23	24	25	26	27	28
31	29	30	31				

KOLOVOZ

W.	P	U	S	Č	P	S	N
31				1	2	3	4
32	5	6	7	8	9	10	11
33	12	13	14	15	16	17	18
34	19	20	21	22	23	24	25
35	26	27	28	29	30	31	

RUJAN

W.	P	U	S	Č	P	S	N
35							1
36	2	3	4	5	6	7	8
37	9	10	11	12	13	14	15
38	16	17	18	19	20	21	22
39	23	24	25	26	27	28	29
40	30						

LISTOPAD

W.	P	U	S	Č	P	S	N
40		1	2	3	4	5	6
41	7	8	9	10	11	12	13
42	14	15	16	17	18	19	20
43	21	22	23	24	25	26	27
44	28	29	30	31			

STUDENI

W.	P	U	S	Č	P	S	N
44					1	2	3
45	4	5	6	7	8	9	10
46	11	12	13	14	15	16	17
47	18	19	20	21	22	23	24
48	25	26	27	28	29	30	

PROSINAC

W.	P	U	S	Č	P	S	N
48							1
49	2	3	4	5	6	7	8
50	9	10	11	12	13	14	15
51	16	17	18	19	20	21	22
52	23	24	25	26	27	28	29
1	30	31					

BILJEŠKE

A series of horizontal dotted lines for writing notes.



Einhell

AKU KOMPETENTNOST.



DVA PARTNERA. JEDNA MISIJA.
MAKSIMALNE PERFORMANSE.

POWER X-CHANGE



Official Tool Expert



AMG
PETRONAS
FORMULA ONE TEAM

KATALOG 2023/2024

Einhell Croatia d.o.o.
Pustodol Začretnski 19/H
49223 Sveti Križ Začretje

info@einhell.hr
www.einhell.hr
Tel: +385 49 342 444
Fax: +385 49 342 392
OIB: 89224272027



Servis
+385 49 342 444 (1)
servis@einhell.hr



Rezervni dijelovi
+385 49 342 444 (2)
rezervni.dijelovi@einhell.hr



Komercijala
+385 49 342 444 (3)



Računovodstvo
+385 49 342 444 (4)



Informacije
+385 49 342 444 (5)
info@einhell.hr

Imate pitanja o našim proizvodima?
Želite naručiti rezervni dio?

Einhell BiH d.o.o.
Poslovni centar 96
72250 Vitez

info@einhell.ba
www.einhell.ba
Tel: +387 30 717 250
Fax: +387 30 717 255



Servis i rezervni dijelovi
+387 30 717 251, 717 847
servis@einhell.ba



Komercijala
+387 30 717 253
prodaja@einhell.com



Računovodstvo
+387 30 717 250
tanja.lekic@einhell.com

Vaš proizvod ne radi kako bi trebao?
Stojimo Vam na usluzi!

Einhell d.o.o. Beograd
Vojvođanska 386
11271 Beograd - Surčin

www.einhell.rs
Tel: +381 11 2269 171/181
Fax: +381 11 2269 163



Servis
+381 11 2269 161/162
servis@einhell.com



Komercijala
+381 11 2269 171/181 (1)
komercijala@einhell.com



Računovodstvo
+381 11 2269 171/181 (3)
zoran.stamenkovic@einhell.com
gordana.cukic@einhell.com



Logistika
+381 11 2269 171/181 (4)
novak.kosanin@einhell.com